

SEGA
PINBALL, INC.

45
40
57

**BATMAN™
FOREVER**



Batman Forever™ © 1994. DC Comics (Licensee Warner Bros. © 1995). All Rights Reserved.

**SAMPLE GAME MANUAL
THIS MANUAL IS NOT COMPLETE**

JOE BLACKWELL
TECHNICAL SUPPORT
MANAGER

ERIC WINSTON
TECHNICAL SUPPORT
ENGINEER

TED KILPIN
TECHNICAL SUPPORT
ENGINEER

JAY ALFER
TECH. DOCUMENTATION
ADMINISTRATOR

Sega Pinball, Inc.™
© 1995. All Rights Reserved.

780-5038-00

Portals™ Service Menu System

The manual has been reformatted to coincide with the Portals™ Service Menu. As the operator navigates through the new system on the display, the operator can follow along with this manual. This manual will be divided into Sections and Chapters. The entire Portals™ Service Menu is covered in Section 3 with all its chapters. For instructions and details of this Portals™ Service Menu please read through the entire Section 3 before operating the Portals™ Service Menu. The other Sections and Chapters will cover the remainder of information as covered in previous manuals.

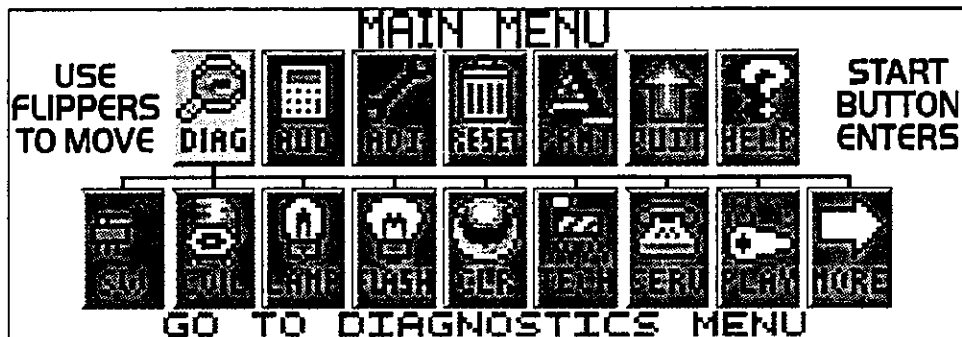

Board Compatibility (Reflexive & Non-Reflexive) of CPU Boards

Version 1 and 2—Reflexive—Solenoid Drive Transistor is enabled directly by a *switch closure* on the solenoid assembly. Version 3—Non-Reflexive—Solenoid Drive Transistor is enabled by the CPU after reading a *switch closure* in the Switch Matrix. All CPU Boards are *backwards compatible* (e.g. Jurassic Park/Ver. 3 to Time Machine/Ver. 2). Swapping a Version 2 Board to a Version 3 is not possible due to the special solenoids section (i.e. Slingshots, Turbo Bumpers, etc.) changing from Reflexive to Non-Reflexive on Version 3 Boards.

Power-Up CPU Self Tests

Upon power-up, the CPU Board performs a series of self tests of major components. Turn the game on while observing the LEDs on the CPU Board. Tests of the PIAs, RAM, and EPROMs are performed automatically and results of the tests are indicated by the PIA LED.

With all tests passed, the LEDs illuminate in the following sequence at power turn-on. The PIA and +5v LEDs illuminate immediately. Approximately 1/2-second later, the PIA LED goes out and the Blanking LED illuminates; the Blanking and +5v LEDs remain illuminated (normal operation) until the game is turned off (see Fig. 1). Test failures are indicated with the PIA LED lit.

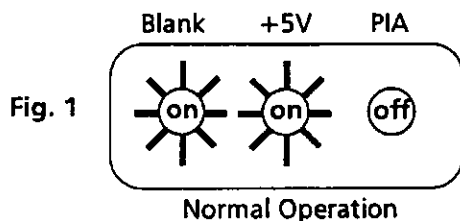

PIA LED	SUSPECT COMPONENT
Stays On:	One of the 6821 PIAs
Flashes 1 Time:	6264 RAM at location D5
Flashes 2 Times:	EPROM at location C5

The *display flashes "OPEN THE COIN DOOR"* — This indicates that memory has been corrupted. This is caused by either failure in memory (e.g. batteries are dead or faulty RAM) or upon installation of updated version of code. Opening the Coin Door will initiate a Factory Restore, by opening the Memory Protect Switch. Check battery voltage at CMOS RAM with power off.

QUICK REFERENCE FUSE CHART

PPB BOARD	
Fuse	
F1	5A Slo-Blo G.I. 6.3v AC
F2	5A Slo-Blo G.I. 6.3v AC
F3	5A Slo-Blo G.I. 6.3v AC
F4	5A Slo-Blo G.I. 6.3v AC
F5	5A Slo-Blo Flipper Power & 50v coils
F6	5A Slo-Blo Flash Lamps (32v DC) Right
F7	3A Slo-Blo Flipper Power & 32v coils Left
F8	4A Slo-Blo 50v coils
F9	5A Slo-Blo 50v coils

POWER SUPPLY BOARD	
Fuse	
F1	7A Slo-Blo +5vDC Regulator Input (9v AC)
F2	7A Slo-Blo +5vDC Regulator Input (9v AC)
F3	Not Used
F4	8A Slo-Blo Switched Illumination Buss (18v DC)
F5	4A Slo-Blo Solenoid (32v DC)... Bumpers, Slingshots, etc.
F6	5A Slo-Blo Solenoid Buss (32v DC)



BATMAN[™] FOREVER

Table of Contents



See Section 3 Table of Contents for the details of that section and it's chapters.

SECTION 1	1
CHAPTER 1, GAME SPECIFICATIONS	1
Power Requirements.....	1
EPROM Summary.....	1
Transportation.....	1
Overall Dimensions.....	1
Game Assembly Procedures.....	2
▶ Leg Leveler Adjustment.....	3
▶ Easy Access Service System.....	3
▶ Backbox Layout, Fuse & Relay Locations.....	4
SECTION 2	5
CHAPTER 1, GAME OPERATION & FEATURES	5
Start of Game Features.....	5
▶ Starting A Normal Game.....	5
▶ Starting Team Play (Doubles!).....	5
▶ Starting League / Tournament Play.....	5
▶ Extra Ball (EB) Buyin.....	5
▶ Feature Buyin.....	5
End of Game Features.....	6
▶ Game Endings.....	6
▶ Match Feature.....	6
▶ Entering Initials.....	6
▶ Manual Percentaging.....	6
CHAPTER 2, GAME RULES	7
SECTION 3	15
CHAPTER 1, PORTALS[™] SERVICE MENU INTRODUCTION	15
▶ Portals [™] Service Menu Table of Contents (View this table of contents for outline of this section).....	15
Portals [™] Service Menu Access & Use / How To Use This Section.....	16-17
Portals [™] Service Menu Icons / Tree.....	18-19
Portals [™] Service Menu Example.....	20-22
CHAPTER 2, GO TO DIAGNOSTICS MENU	23
CHAPTER 3, GO TO AUDITS MENU	34/35
CHAPTER 4, GO TO ADJUSTMENTS MENU	40/41
CHAPTER 5, GO TO RESET MENU	49
CHAPTER 6, GO TO PRINTER MENU (Special Equipment Required)	51
CHAPTER 7, GO TO HELP SCREEN	52/53
SECTION 4	55
CHAPTER 1, PARTS IDENTIFICATION & LOCATION (The Pink Pages)	55
Backbox - General Parts.....	56
Cabinet - General Parts.....	57
Playfield - Major Assemblies.....	58
Playfield - Ramps & Rails.....	59
Playfield - Butyrate & Decals.....	60
Playfield - General Parts.....	61
Playfield - Metal Posts & Spacers (Actual Size).....	62
Playfield - Plastic Posts & Spacers (Actual Size).....	63
Playfield - Rubber Parts (Rings Actual Size).....	64
Playfield - Wedge Base Type Bulbs & Sockets (Actual Size).....	65
Playfield - Bayonet Type Bulbs & Sockets (Actual Size).....	66, 67
Playfield - Lamp Boards.....	68
CHAPTER 2, ASSEMBLY DRAWINGS (The Blue Pages)	69
Gun Assembly.....	70
6-Ball Trough (OPTO) Assy. (500-XXXX-00-38), Lock Ball Assy. (500-5684-01-38),	
Ball Trough Exit Scoop (535-7329-00).....	71
Flipper Assemblies, Lower Right (500-XXXX-01-38 and Lower Left (500-XXXX-02-38).....	72
Flipper Assembly, Upper Right (500-XXXX-01-38).....	73
Slingshot Assemblies (500-5849-00-38).....	74
Knocker Assembly (In Cabinet)(500-5081-00-38).....	74
Turbo Bumper Assemblies (500-5XXX-01-38).....	75
Shooter Lane Auto Ball Launch Assembly (500-XXXX-00-38).....	76
Arch Wire Ramp Auto Ball Launch (500-XXXX-0X-38).....	76
Laser Kick Assembly (Under Arch) (500-5838-01-38).....	77

SECTION 4, CHAPTER 2, ASSEMBLY DRAWINGS (The Blue Pages) Continued	
Vertical Up-Kicker (VUK) Assembly (500-5839-01-38).....	77
Ball Eject Assembly (500-XXXX-01-38).....	78
Upper Right Wire Ramp Lock Ball Assembly (500-XXXX-01-38).....	78
Center Wire Ramp Ball Flip Bridge Assembly (500-XXXX-01-38).....	79
Cannon Ball Launch Assembly (500-XXXX-01-38).....	79
4-Bank Drop Target Assembly (500-XXXX-00-38).....	80, 81
Left Plastic Dual Ramp (500-XXXX-01-38).....	82
Right Plastic Ramp (500-XXXX-01-38).....	83
VUK to Bottom Arch Wire Ramp (515-XXXX-01-38).....	84
Bottom Arch Wire Ramp (515-XXXX-01-38).....	84
Left Plastic Inner Exit Wire Ramp (515-XXXX-01-38).....	85
Left Plastic Dual Outer & Right Plastic Exit Wire Ramp (500-XXXX-01-38).....	85
Stand-Up Targets Assemblies (used in this game: 500-5857-XX & 500-5835-XX).....	86
SECTION 5.....	87
CHAPTER 1, CABINET SCHEMATICS & TROUBLESHOOTING (The Yellow Pages)	
Table of Contents	87
CHAPTER 2, PLAYFIELD SWITCHES, COILS & LAMPS SCHEMATICS & TROUBLESHOOTING (The Yellow Pages) Table of Contents	
CHAPTER 3, FLIPPERS SCHEMATICS & TROUBLESHOOTING (The Yellow Pages)	
Table of Contents	99
CHAPTER 4, DISPLAY SCHEMATICS & TROUBLESHOOTING (The Yellow Pages)	
Table of Contents	105
CHAPTER 5, BACKBOX SCHEMATICS & TROUBLESHOOTING (The Yellow Pages)	
Table of Contents	113
APPENDIXES A - H	109
Appendix A - CPU Jumper Table.....	111
Appendix B - Pinball Game Firmware.....	112, 113
Appendix C - Board Type Table.....	114, 115
Appendix D - Generic Coil Cross-Reference Guide & Flipper Coil Table.....	116, 117
Appendix E - Motor Specifications Table	118, 119
Appendix F - Semi-Conductor / Integrated Circuits / Relays Cross-Reference Guide.....	120, 121
Appendix G - Part Number Prefix Classification Codes Explanation	122
Appendix H - Playfield Inserts (Plastic Light Covers)	123
GLOSSARY OF TERMS



Game Specifications

Power Requirements

This game is provided with a 3-prong plug and *must be connected to a properly grounded outlet to reduce shock hazard* and insure proper game operation. Refer to AC Power Wiring Diagram for transformer connections required for normal, high, and low line conditions.

Normal Line:	109 to 129 -Volts AC (211 to 225 -Volts AC)
High Line:	(226 to 235 -Volts AC)– European, International
Low Line:	95 to 108 -Volts AC (200 to 210 -Volts AC)

EPROM Summary

CPU Board:	Location C5
Sound Board:	Locations U17 (Voice ROM 1), U21 (Voice ROM 2), and U7 (Sound ROM)
Display Controller Board:	Location U1 (ROM 0) and U4 (ROM 3)

Transportation

To reduce the possibility of damage, observe the following precautions whenever transporting the game. Lower the backbox and secure it to the cabinet. Remove the legs and secure the game within the transporting vehicle.

Overall Dimensions

Shipping Crate Dimensions	
Height:	55½"
Width:	30½"
Length:	31"
Approx. Wt.:	250 lbs.

† Note:
The Leg Levelers can add up to two (2) inches to the overall height of the front and back dimensions.

The cabinet is designed to give a 6.5° pitch with the Leg Levelers turned all the way in.

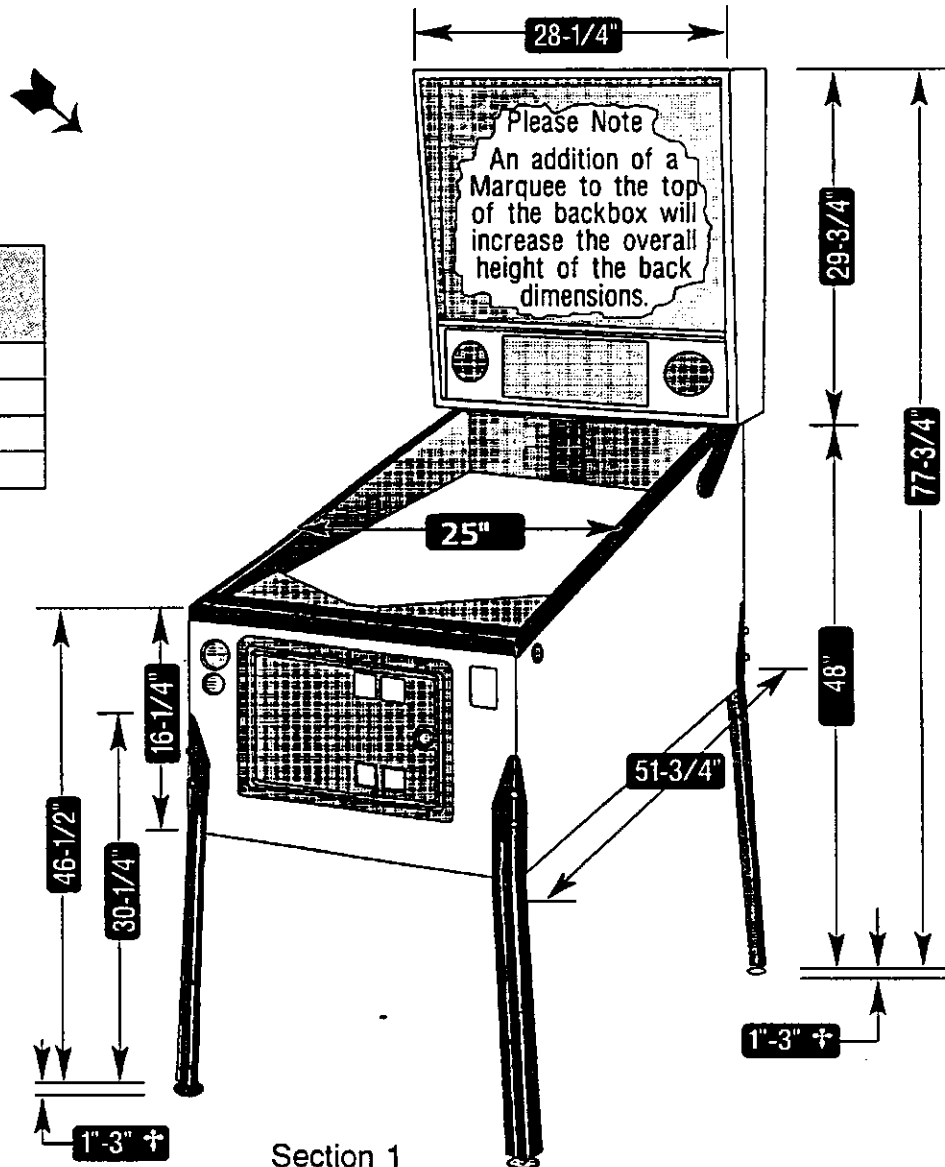

Game Assembly Procedures

(Refer to the Illustrations on pages 3 & 4)

1. Open the top of the carton and lay it on its side with the bottom of the cabinet down. Using the plastic banding strip as a handle, slide the game out of the carton.
 2. Remove all packing material. Cabinet legs are located on top of the front molding above the coin door and the assembly parts package is in the cashbox. There should be four leg levelers, eight leg bolts, six pinballs (quantity may differ depending if the game is a 4-, 5-, 6-Ball game) and a large Allen Wrench, used for securing the backbox, is inserted & taped to the rear of cabinet.
 3. Leg Levelers may already be attached. If not, attach Leg Levelers from the parts package to each leg, make sure that each leveler is threaded through a hex nut before threading it into the leg. See Illustration "Leg Leveler Adjustment" on the next page.
 4. Support rear of cabinet and attach rear legs using two leg bolts for each leg.
 5. Support front of cabinet and attach front legs using two leg bolts for each leg.
 6. While assuring that no cables are being pinched, carefully raise the backbox and secure it in its upright position with the Allen Wrench in the hole in the back of the cabinet and rotating the wrench 270° (¾ turn).
 7. Remove the backbox keys from the playfield glass, unlock and carefully remove the backglass. Set the backglass aside.
 8. Check all connectors in the backbox for loose wire terminations. Reseat any loose wire by pushing in on the terminal. Push on all connectors plugged into the CPU Board, Sound Board, Power Supply Board, and Display Board to check that they are properly seated.
 9. Check that the fuses on the Power Supply Board, PPB Board and Back Panel are seated properly.
 10. Carefully remove the playfield glass and set it aside.
 11. Remove all shipping tie downs, shipping instruction pages, packing foam, etc. Read all printed information taken from the playfield. It contains warning(s), caution(s) and/or information specific to the game.
 12. Raise the playfield and support it, by lifting the Stay Arm on the Right Side of the Cabinet and locking it into the slotted bracket on the playfield. (Use the instruction sheet provided in the game to see alternative methods of accessing the playfield bottom.)
 13. Check all cabinet cables and playfield Lamp Boards connector terminations.
 14. Remove the Plumb Bob tilt from the parts package and install on the pendulum wire on the inside left of the cabinet. (See Cabinet Parts Illustration.)
 15. Lower the playfield and ensure game is level side-to-side by adjusting Leg Levelers, if required.
 16. The game pitch should be at a 6.5° pitch. Depending on the condition of the floor, adjust as required.
- The playfield incline affects difficulty of play. Use the recommended incline; Game difficulty is best varied using game adjustments.***
17. Check the plumb tilt and adjust as required.
 18. If desired, perform any self tests at this time. See Section 3, Chapter 2, Diagnostics for instructions on how to enter Play Test.
 19. With the insert door closed, carefully reinstall and lock the backglass.
 20. Place the six (or game quantity) pinballs on the playfield near the outhole and carefully reinstall the playfield glass.
 21. If desired, make Game Pricing (Standard and/or Custom) and Add-A-Ball, Novelty, or 5-Ball Play adjustments at this time. See Section 3, Chapter 3, Adjustments for instructions on how to enter adjustments. Follow instructions in the tables provided in the manual for suggestions of customizing changes.

Leg Leveler Adjustment

This cabinet is designed to automatically have a 6.5° pitch without any Leg Leveler adjustment!

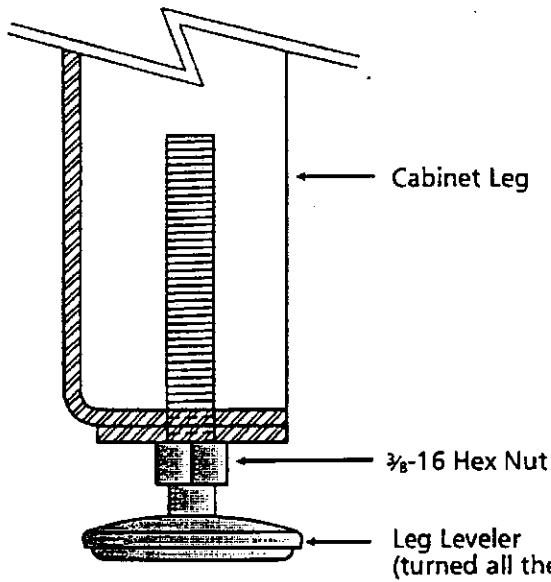

STEP 1

Assemble all (4) legs and levelers as shown in the diagram. Be sure the leveler is turned all the way in.

STEP 2

Attach leg assemblies to cabinet with leg bolts provided.

YOUR PLAYFIELD PITCH IS NOW AT 6.5° AS REQUIRED FOR PROPER GAME PLAY!

STEP 3

Verify 6.5° pitch. Minor adjustment(s) may be necessary depending on the location floor being level.

For custom adjustment greater than 6.5° can be achieved by turning out the leg leveler, however, it is not recommended.

Easy Access Service System

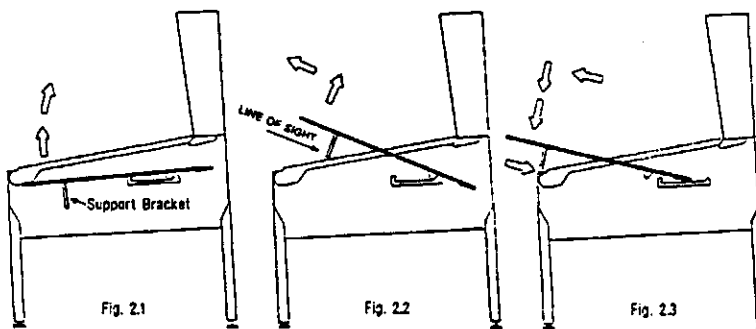

Service Position 1

This position is useful to service:

Trough Switches, Connectors at back of cabinet, Cleaning the Playfield, etc.

Lift the playfield *using the left and right ball guides* upward (Fig. 2.1) until the playfield support brackets can be seen to clear cabinet front (Fig. 2.2). At this time, pull playfield toward the front of the cabinet, checking that the mechanical components clear the cabinet front (Fig. 2.3). Then rest the playfield on the support brackets at the front channel of cabinet. *Reverse procedure when service is complete.*

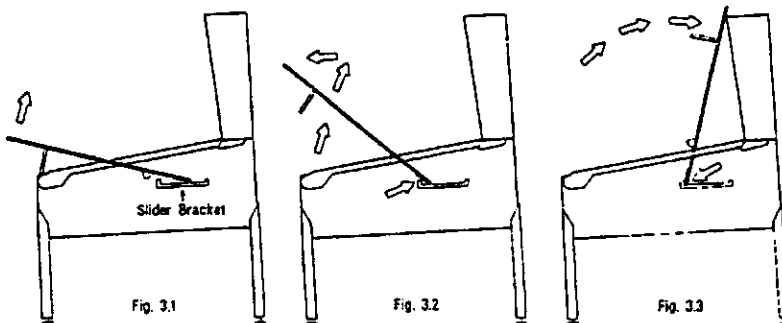

Service Position 2

This position is useful to service:

All Playfield Bottom Components, Cabinet Components, etc.

With the playfield at rest (Fig. 3.1), hold sides of playfield and pull toward the front of the cabinet (approx. 6" to 8"), until resistance is felt from the slider brackets located on either side of the cabinet (Fig. 3.2). At this time, swivel playfield toward the backbox, then rest on top edge of the backbox. *Reverse procedure when service is complete.*

Backbox Layout, Fuse & Relay Locations

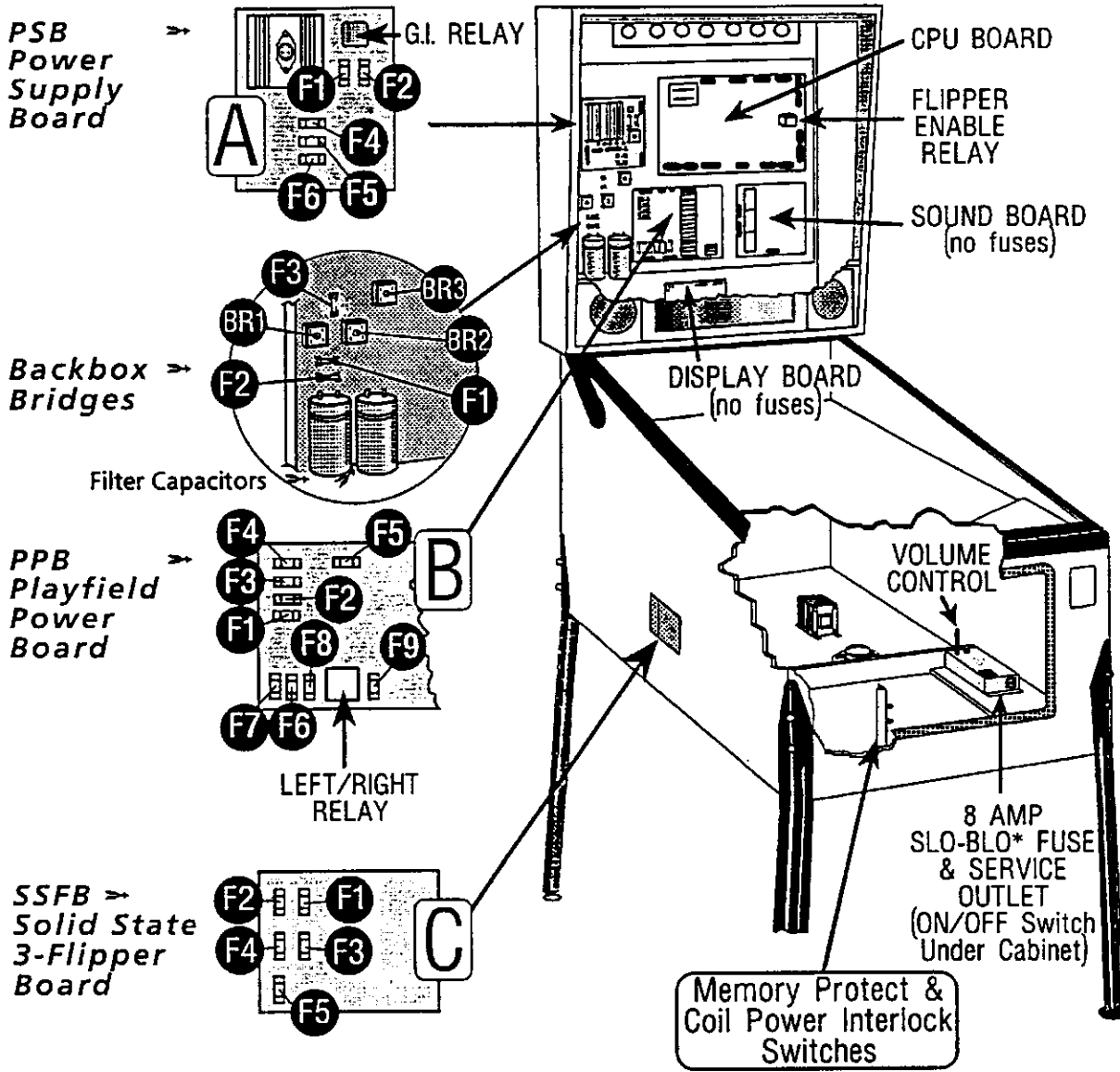

Note: Backbox Part Numbers on Page 7

Service Switches are located on the Coin Door.

A: In the Backbox Power Supply Board P S B	
F1	7A Slo-Blo +5vDC Regulator Input (9vAC)
F2	7A Slo-Blo +5vDC Regulator Input (9vAC)
F3	Not Used
F4	8A Slo-Blo Switched Illumination Buss (18vDC)
F5	4A Slo-Blo Solenoid (32vDC) Bumpers, Slingshots, etc.
F6	5A Slo-Blo Solenoid Buss (34vDC) L/R Relay Coils/Flash

B: In the Backbox Playfield Power Board P P B	
F1	G.I. 5A Slo-Blo Playfield
F2	G.I. 5A Slo-Blo Backbox Dr./Sopr. Panel
F3	G.I. 5A Slo-Blo Playfield & Coin Door
F4	G.I. 5A Slo-Blo Backbox Door
F5	50v 5A Flippers /All 50v Coils
F6	32v Flash Lamps 3A Slo-Blo/Right
F7	32v 3A Coils/Flash Right/Left
F8	50v 4A / 50v Coils
F9	50v 5A Laser Kick

C: In the Cabinet Solid State 3-Flipper Bd. S S F B	
F1	3A 250v Slo-Blo 50v DC Output (All Fuses) Lower Right Flipper
F2	3A 250v Slo-Blo 9v AC Holding
F3	3A 250v Slo-Blo 50v DC Output Lower Left Flipper
F4	3A 250v Slo-Blo 9v AC Holding
F5	3A 250v Slo-Blo 50v DC Output Upper Right Flipper

...In the Backbox Backbox Bridges Mounted in Backbox	
F1	8A Slo-Blo 32v DC BR2 Coils/Flashers
F2	8A Slo-Blo 18v DC BR1 Lamps
F3	8A Slo-Blo 18v DC BR3 Display
Cabinet Fuses	
Main Fuse Line: 8A Slo-Blo 250v	
International 2X 4A Slo-Blo 250v	

Game Operation & Features

Start of Game Features

Starting a Normal Game

Insert coin(s), the game generates a sound ("SEGA!") for the first coin & for each subsequent coin(s) with the display indicating the number of credit(s) posted. Press the Start Button and a start-up sound is produced, and the posted credit(s) are reduced by one. The display now indicates the player or # of players selected from the total depressions of the START BUTTON. 1 to 6 can play! The display indicates the ball in play, and a ball is served to the *Shooter Lane*. Additional players may be added by pressing the START BUTTON *before* the end of ball 1. At game start, an introduction is shown followed by Skill Shot Graphics. Pressing the START BUTTON after ball 1 of any player will start a new game (if credits are available), *but only* if the START BUTTON is depressed for 2-3 seconds. This delay is to avoid accidental "re-starts" of a game. (Note: Any 1/2 credit remaining during game play after the end of ball 1, or power down, will be eliminated.)

Starting Team Play (Doubles!)

Team Play is a four player game. The totals for players 1 & 3 (Team 1) and players 2 & 4 (Team 2) are displayed individually as well as the combined score for both teams. Team Play does not work with less than or more than 4 players. 1-, 2-, 3-, 5- & 6-Player games, the individual scores are shown.

Starting League/Tournament Play

After credit is posted, press the EXTRA BALL BUYIN/LEAGUE BUTTON instead of the START BUTTON. League Play has now begun. The differences between Normal Game Play and League/Tournament Play are: There is no "BOZO Spotting" (programmers term for awarding points and/or features which are to difficult to achieve by the average player). Mystery Features are awarded in a set order rather than random in Normal Game Play. Percentage Game Features are not automatically advanced as they are for the Novice Play Features.

Extra Ball (EB) Buyin

Adj. 34, Buyin Type, has to be set to EXTRA BALL (Default). An option to add an extra ball(s) after the game is finished is given (it doesn't matter if the game is set as a 2-, 3-, 4-, or 5-Ball Game). The score and game features already earned are retained and the player can add to the score with this extra ball. To activate the EXTRA BALL BUY-IN FEATURE, the player must press the EXTRA BALL BUYIN BUTTON after pressing the START BUTTON. At the end of normal game play, the same player may choose to continue the game at the same score and features active by pressing the EXTRA BALL BUTTON prior to the expiration of the "countdown timer." The posted credit will be reduced by one. Letting the timer to expire, pressing the START BUTTON or BOTH flippers simultaneously cancels this feature. If the player does not have any credits, the player will get "more time" to add credit.

Adjustable features: See Section 3, Chapter 3, Adjustments. In Adj. 34, Buyin Type, the factory default is EXTRA BALL. Changing the setting to FEATURE or NONE will cancel Extra Ball Buyin. The number of extra balls which can be added to a game can be adjusted with Adj. 35, Extra Ball Buyin Count. Default is 1. Set to 1, will allow only 1 extra ball to be purchased per game. Set to UNLIMITED, after the end of the game the count-down will appear after the end of each ball for the option of purchasing another extra ball. Set to 0, will also make this feature unavailable. Adj. 12, Ball Per Games, the factory default is 3. The game can be set to allow how many balls are given in normal game play. This can be set from 2 to 5.

Feature Buyin

Adj. 34, Buyin Type, has to be set to FEATURE. This option starts a new game, however, the score is reset but the game features already earned are retained. To activate this FEATURE, the player must press the EXTRA BALL BUYIN BUTTON after pressing the START BUTTON to start a game or during the course of the game. At the end of normal game play, the same player may choose to restart the game with game features already earned by pressing the EXTRA BALL BUTTON prior to the expiration of the "countdown timer." The amount of balls per game is adjustable (see below). The posted credit will be reduced by one. Letting the timer to expire, pressing the START BUTTON or BOTH flippers simultaneously cancels this feature. If the player does not have any credits, the player will get "more time" to add credit.

Adjustable features: See Section 3, Chapter 3, Adjustments. In Adj. 34, Buyin Type, the factory default is EXTRA BALL. Changing the setting to NONE will cancel both features. Adj. 12, Ball Per Games, the factory default is 3. The game can be set to allow how many balls are given in normal game play. This can be set from 2 to 5.

End of Game Features

Game Endings

When all player(s) have played all balls (including any Extra Ball Buyin's), the game ends. If power is interrupted during the course of a game will end that game (*see Starting a Normal Game*). The second closure (adjustable) or prolonged closure of the Plumb Bob Tilt Switch tilts the ball in play. Closure of the Slam Tilt Switch on the coin door ends the current game(s).

Match Feature

At the end of each ball, earned bonuses are collected. At the end of the last ball of a game (including any extra balls, if applicable), earned bonuses are collected, then the system produces a random 2-digit number (a multiple of 10; 00 to 90) for a Match feature (adjustable). Matching the last two digits of a player score with this number awards a credit.

Adjustable feature: Some geographical areas do not allow the award of a free game, this can be adjusted with Adj. 3, Replay Award. Players exceeding high score levels receive free credit(s), an extra ball or set to NONE to deactivate the Replay Award.

Entering Initials

If player achieved a new high score, the player may enter his/her initials. To enter your initials, use the left & right flipper buttons to choose letter or character as seen on the Visual Display. Hitting the Start Button locks the letter or character in. Proceed with the 2nd & 3rd letter. The game then proceeds into the game-over mode and then to the attract mode. A custom message (adjustable) can be displayed during the attract mode.

Manual Percentaging

This game is equipped with Manual Percentage Adjustment. As previously with our games, you can either set operator adjustments for a replay percent or you can set a fixed replay score. See Section 3, Chapter 3, Adjustments, Adjustment 1 & 2.

If you set operator adjustments for a particular replay percent, the game will compute a recommended score to keep the game at that replay percentage. If a change is recommended and the game coin door is opened, the display will indicate a recommended replay score to beat and make a sound to alert the operator. By pressing the start button, the score to beat will be changed to the recommended level. If you close the coin door or enter the Portals™ Service Menu, no score change will be made.

You may choose to ignore the recommended change; for example, you may not think last week's players were the usual crowd. Just close the door and the message will disappear without altering the existing level. Or you may choose to make a different score to beat adjustment; this is done by utilizing Adj. 2, Replay Levels.

Game Rules

Overview

Below is the Batman Forever™ Playfield with all of it's component locations indicated (for details on these parts, see Section 4). Read over the components below to help in understanding the effects of the game rules. Each rule is numbered with it's corresponding number describing the elements related, and/or ball path the rule is describing on the playfield.

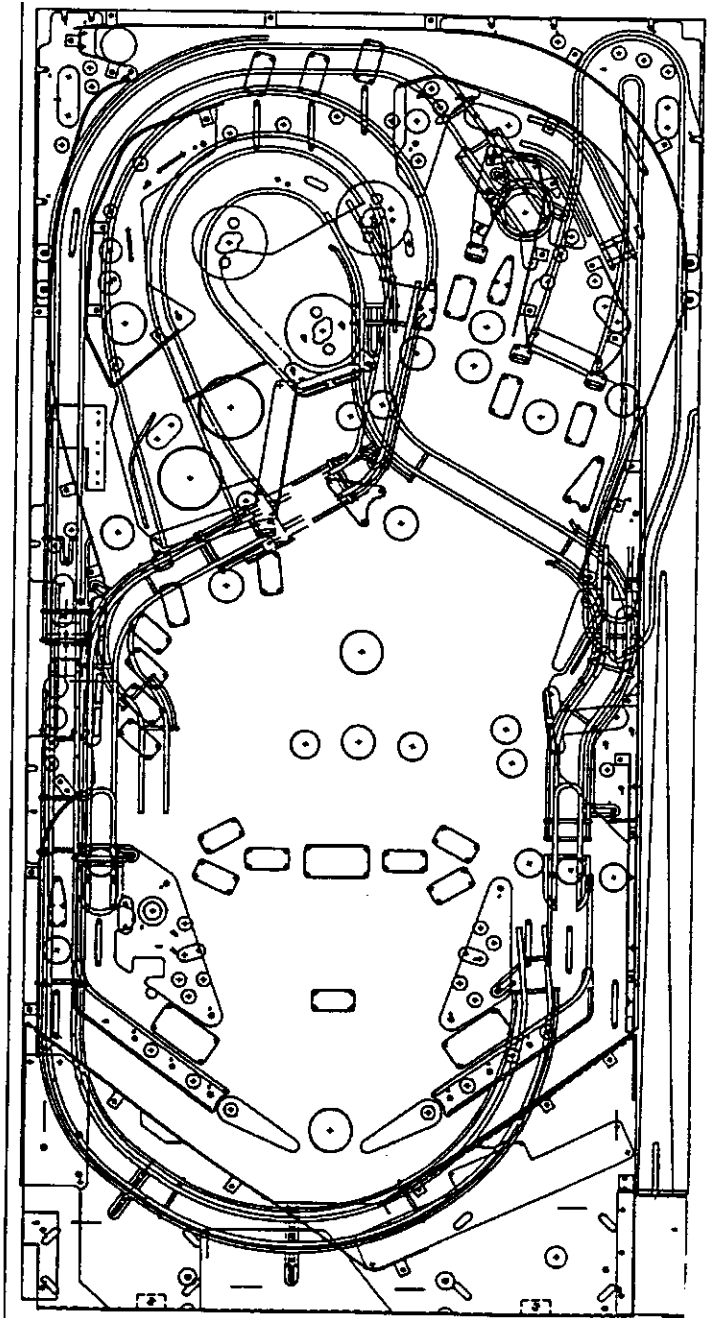

Game Rules

Instruction Card

Below is a copy of the game instruction card which is included with everygame. If this card is lost or damaged, simply copy this page and cut out the instruction card as a temporary replacement until a new card is ordered. (Suggestion: Copy & cut along the dotted line and fold in the center. This will keep the "copy" sturdy.)

Copy & Cut

Fold

Fold



SKILL SHOT - Pull *Gun Trigger* for award shown in the display.
MULTIBALL - Complete the **CAVE** targets to lite lock at hole. Lock 3 balls to start *Multiball*.
GOTHAM EVENTS - Complete the "?" targets to light **GOTHAM EVENT**. The *Gun Trigger* locks in the event.
BATWING - Shoot the Middle, Right, & U-Turn Ramps to ready the **BATWING CANNON**. Shoot the Left Ramp when lit to arm the **BATWING** - pull the trigger to shoot the ball at the lit targets.
ROVING BATS - Shoot the flashing *Bat Shots* during single ball play. Completing all shots begins the **CIRCUS COUNTDOWN**.
TWO FACE COINS - Match the *Good Heads Coins* for **Hold Bonus**. Match the *Bad Heads Coins* for 22 million points.
FOREVER - Play all of the **GOTHAM EVENTS**, match both pairs of coins, and complete the *Roving Bats* to light **FOREVER**.
TOP LANES - Complete "BAT" to advance Bonus X and relite Laser Kick.

Sega Pinball, Inc.™
© 1995. Batman
Forever.™ & DC
Comics. © 1994.
Warner Bros.
Licensed © 1995.
755-5075-00

The remainder of this chapter is Batman Forever Game Rules. Please read through for a better understanding of the operation of this game. Some game rules, point values and/or features may change as production continues. The changes, if any, will be describe in manual addendums, if warranted. Please note, that some adjustments (see Section 3, Chapter 3, Adjustments) are designed to customize game play. (i.e. making it harder or easier as gamers get more familiar with the game.)

Code revisions and updates may change as production continues. Code updates will be made available to distributors via ROM, diskette or modem. Changes, if any, will be described with the code updates. The latest revision code for all games prior to this game are described in Section 7, Chapter 1, Appendix B, Pinball Game Firmware.

Review Chapter 1 of this Section 2, for Start and End of Game Features. Team Play and League/Tournament Modes may differ slightly then the rules describe herein. (e.g. Score values are combined. Features are awarded in order vs. random, etc.).

Our games feature elaborate video modes and video graphics. Don't forget to watch your video display for hints or feature demonstrations. The video modes require the player to play on-screen. When in video mode, the ball-in-play is "held" (usually in a scoop or lock of some sort). The interactive video play requires the player to use the flipper buttons to play the mode. After the video mode is terminated, the ball is returned to play! So pay attention to where your ball may exit.

See Section 7, Chapter 2, Glossary of Terms, for words or acronymns you may not understand. If an acronym or expression is not in this glossary, please call our Technical Support Department, so we made add it in the next game manual. Any other suggestions or comments are also welcome!

Portals™ Service Menu Introduction



Section 3 Table of Contents

- Chapter 1, Introduction.....
 - Access & Use / How to Use This Section
 - All Icons / Icon Tree
 - Example
- Chapter 2, • Go To Diagnostics Menu
 - Go To Switch Menu.....
 - Switch Test
 - Active Switch Test
 - ▣ Switch Matrix Chart.....
 - ▣ Switch Matrix Locations, Descriptions & Part Numbers
 - Go To Coil Menu
 - Coil Test.....
 - Cycling Coil Test
 - ▣ Playfield Coils Locations.....
 - ▣ Switched, CPU Controlled Auxillary & Constant Power Solenoids & Flipper Solenoids
 - ▣ Coil Schematic
 - Go To Lamp Menu.....
 - Single Lamp Test
 - Test All Lamps
 - Row Lamp Test.....
 - Column Lamp Test.....
 - ▣ Lamp Matrix Chart.....
 - ▣ Lamp Matrix Location & Descriptions.....
 - Test Flash Lamps
 - ▣ Playfield & Backbox Flash Lamps Locations
 - Clear Ball Trough.....
 - Technicians Alert.....
 - Service Phone #
 - Begin Play Test
 - Sound/Speaker Test.....
 - ▣ Sound Test Chart
 - ▣ Speaker Phase Testing
 - Dot Matrix Test
 - Game Specific
- Chapter 3, • Go To Audits Menu
 - ▣ Game Audit Table.....
 - Earnings Audits
 - Sega Audits
 - Batman Forever Audits
- Chapter 4, • Go To Adjustments Menu
 - ▣ Game Adjustment Table
 - Sega Adjustments
 - Batman Forever Adjustments
- Chapter 5, • Go To Reset Menu
 - Factory Restore
 - Reset Coin Audits
 - Reset All Audits
- Chapter 6, • Go To Printer Menu
 - Quick Printout.....
 - Full Printout
 - N° of Copies Printed
- Chapter 7, • Go To Help Screen.....
 - Go To Help Screens (Multi-Level)
 - ▣ Problem/Solution Table



Bullet Notes:

- From Main Menu, Level 1.
- From the Sub-Menu, Level 2.

- From the Sub-Menu, Level 3.
- ▣ Added Information/Instruction.

Access & Use

Step 1

Open Coin Door and view Service Switch Set. (Memory Protect is now disabled.)

Step 2

Enter the Portals™ Service Menu by pushing the Black "BEGIN TEST" Button.

Step 3

Use the Green "SELECT" Button or Flipper Buttons to navigate through the menus. Use the Black "ENTER" Button or Start Button to activate icons.

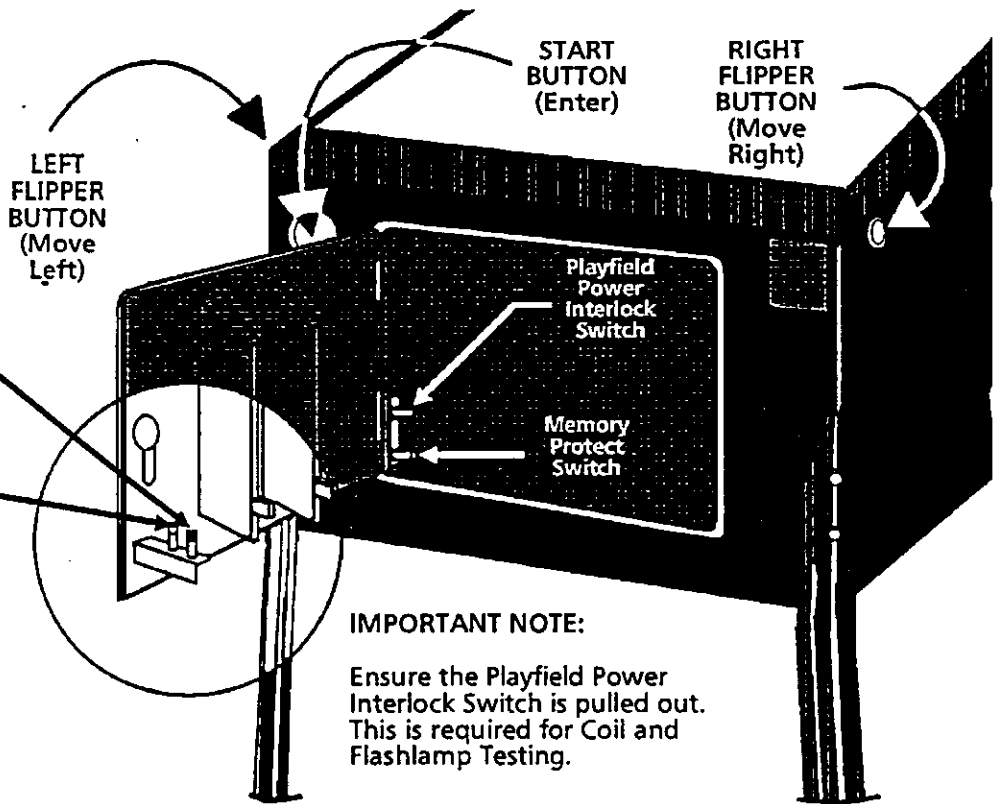

IMPORTANT NOTE:

Ensure the Playfield Power Interlock Switch is pulled out. This is required for Coil and Flashlamp Testing.

Section 3 | Chapter 1

GREEN BUTTON:

FUNCTION 1:
(Not in the Service Mode)

SERVICE CREDITS:
Allows the technician to Test/Play the game without adding any counts to the Coin Audits. Up to 30 credits can be applied.

FUNCTION 2:
(In the Service Mode)

SELECT:
Allows the technician to select an Icon by moving right (forward) only.

BLACK BUTTON:

FUNCTION 1:
(Not in the Service Mode)

BEGIN TEST:
Allows the technician to begin the Portals™ Service Menu.

FUNCTION 2:
(In the Service Mode)

ENTER:
Allows the technician to activate Icon selected.



READ THIS:

The Green "SELECT" Button will change the selection by moving *right (forward)* only. For left/right (forward/backward) movement, use the Left & Right Flipper Buttons accordingly. The Start "ENTER" Button is used like the Black "ENTER" Button. When using the Portals™ Service Menu, use the Flipper and Start Buttons to navigate through the menu(s). Use the Black "ENTER" and Green "SELECT" Buttons only while in Switch Test as the Start Button & Flipper Buttons are a part of this test. *Please Note: The Coin Door must be open when changing Adjustments, so that the MEMORY PROTECT SWITCH is disabled.*

How to Use This Section

This section will cover all functions available in the Portals™ Service Menu in a *Step-By-Step* process. This section is divided into chapters which coincide with the MAIN MENU. After reading *Access & Use* on the previous page, view the Section Sub-Table of Contents to familiarize yourself with this section. The following pages in this chapter will instruct the operator on how to navigate through the menus. It's simple, easy and fun to use!

To get into the Service Menu Mode: • Power-up game (if not already) & open the Coin Door. • On the Coin Door is the Service Switch Set. Push down the Black "BEGIN TEST" Button.

Looking at the Video Display you will momentarily see the introductory screen, followed by the MAIN MENU:



The Coin Door may be closed for security, however, please note with the Coin Door closed the game's *MEMORY PROTECT* is enabled; meaning any changes that are made will be not be written to memory. If changing adjustments is required, ensure the Coin Door is open.

Use the Left & Right Flipper Buttons to change the selected ICON left or right, and the Start Button (or Extra Ball Button) to activate the selected ICON. The Green "SELECT" & Black "ENTER" Buttons can be used at any time as well as the Left & Right Flipper Buttons (to select) and Start Button (to enter). The use of the Green "SELECT" & Black "ENTER" Buttons are required in Switch Test or Active Switch Test, as the Start & Flipper Buttons are a part of this test.

For diagnostic purposes, be sure the *Playfield Power Interlock Switch* is pulled out so *Playfield Power* is not disabled.

The MAIN MENU now appears with the "DIAG" Icon (DIAGNOSTICS MENU) flashing:

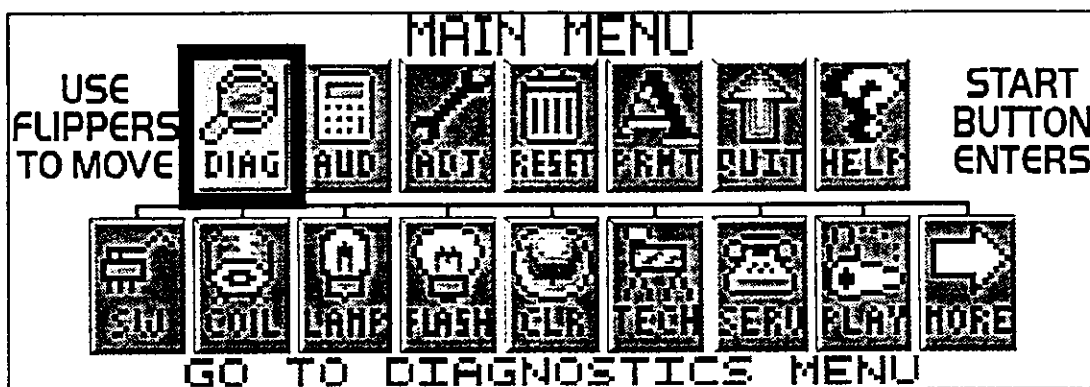









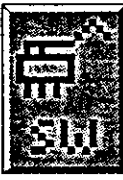





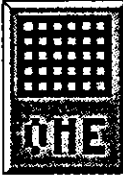
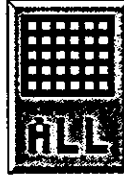

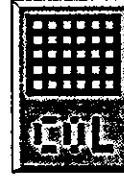

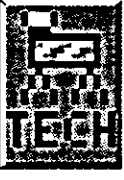











See the sample of an activation of an *Icon* following the Portals™ Service Menu Icons and Tree. View the last chapter (HELP) if more information is required. Selecting the "QUIT" *Icon* with the Green "SELECT" or either Flipper Button, then pressing the Start Button will exit the Service Mode. This applies to the large and small "QUIT" *Icons*.

The chapters in this section, which coincide with the MAIN MENU, will also provide more detailed information which could not fit in the display. Use both the manual and the display to help customize, troubleshoot and/or diagnose faults, if any.

Portals™ Service Menu Icons

Numbers with **ICONS** correlate to Menu Tree 

1 GO TO DIAGNOSTICS MENU 	2 GO TO SWITCH MENU 	3 SWITCH TEST 	4 ACTIVE SWITCH TEST 	5 GO TO COIL MENU 	6 COIL TEST 	7 CYCLING COIL TEST 
8 GO TO LAMP MENU 	9 SINGLE LAMP TEST 	10 TEST ALL LAMPS 	11 ROW LAMP TEST 	12 COLUMN LAMP TEST 	13 TEST FLASH LAMPS 	14 CLEAR BALL TROUGH 
15 TECHNICIAN ALERTS 	16 SERVICE PHONE # 	17 BEGIN PLAY TEST 	18 SOUND/ SPEAKER TEST 	19 BEGIN BURN IN 	20 DOT MATRIX TEST 	21 GO TO AUDITS MENU A 
22 EARNINGS AUDITS 	23 GO TO ADJUSTMENTS MENU 	24 GO TO RESET MENU B 	25 FACTORY RESET 	26 RESET COIN AUDITS 	27 GO TO PRINTER MENU 	28 QUICK PRINTOUT 
29 FULL PRINTOUT 	30 GAME GENERIC AUD/ADJ C 	31 GAME SPECIFIC AUD/ADJ D 	32 "SHOWS MORE ICONS LEFT" 	33 "SHOWS MORE ICONS RIGHT" 	34 GO TO MAIN MENU E 	35 QUIT THIS SESSION 

Letters with **ICONS** are duplicated and are used in different sub-menus.

- A** "Go to Audits Menu" is used also as "Reset All Audits" under "Reset Menu."
- B** "Go to Reset Menu" is used also as "Reset Printer" under "Printer Menu."
- C** The "Sega" icon is displayed to represent Game Generic Audits or Adjustments.
- D** The *current game icon* is displayed to represent Game Specific Audits or Adjustments and is also used under "Diagnostics Menu" for Game Specific Tests. Each game will have it's own icon.
- E** "Go to Main Menu" is used also as "Go to Diagnostics Menu" under Switch, Coil and Lamp Tests.

Go to previous
Aud / Adj /
Diagnostic
(Backward/Left)

Go to next
Aud / Adj /
Diagnostic
(Forward/Right)

Run (or
activate)
selected test

Exit to the
previous
menu

Quit this
service
session



Increment displayed value or select next...
Decrement displayed value or select previous...

Go to this
Help Screen
(of the current
sub-menu)

Portals™ Service Menu Tree

← Numbers with TEXT correlate to Menu Icons

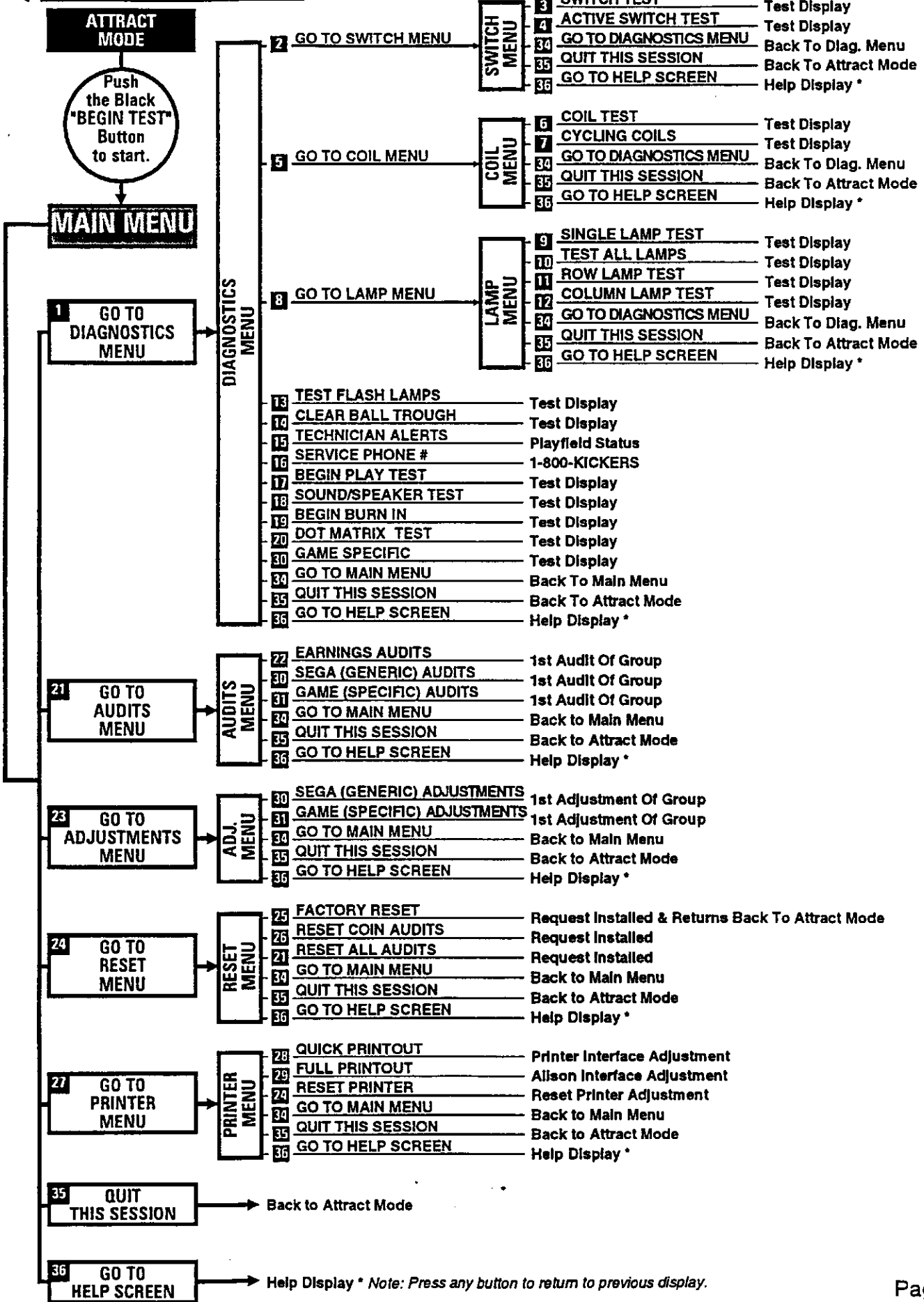

Portals™ Service Menu Example

This example will demonstrate activation of *Icons* in the DIAGNOSTICS MENU. The example will show activation of the "SW" *Icon* (GO TO SWITCH MENU). In this menu, the switches can be tested individually and also all active switches can be tested. Use the same technique to access all the *Icons* in the Portals™ Service Menu. Follow the "All Icons" Table and "Tree" on the previous pages to help navigate through the system. Through the following chapters, any special notes and explanation regarding the Menu of Sub-Menu will be explained.

If the display is in any other menu other than the MAIN MENU, use the Left or Right Flipper Button to select the "PREV" *Icon* and press the Start Button to activate the ICON thus moving back to the previous menu. Do so until MAIN MENU appears.

Chapters 2-7 will cover all menu items within the Portals™ Service Menu. The *Icon* is shown preceding the text. Find the *Icon* in the Portals™ Service Menu by navigating with the Green "SELECT" or Flipper Buttons. Each chapter started is from the Main Menu. Within the chapter, the sub-menu's will be covered sequentially with their explanation & function. If the operator "gets lost", select and activate the "PREV" *Icon* until the display indicates MAIN MENU. For more help, see Chapter 7.



The "MORE" *Icons* are indicating that "more options" are available which don't appear in the display and which way to move the selection to view the *Icons*.



Important Note:



PREV

Exit any sub-menu and return to the MAIN MENU by selecting & activating the "PREV" *Icons*. If no *Icons* appear in the display because of a testing function or special display (e.g. "Help"), press any button to exit.



QUIT

Selecting & activating the "QUIT" *Icon* from any display will exit the Service Session.



Selecting & activating the "HELP" *Icon* will show a help screen.

Example: From the MAIN MENU, use the Left or Right Flipper Button to select the "DIAG" *Icon* (go to DIAGNOSTICS MENU).

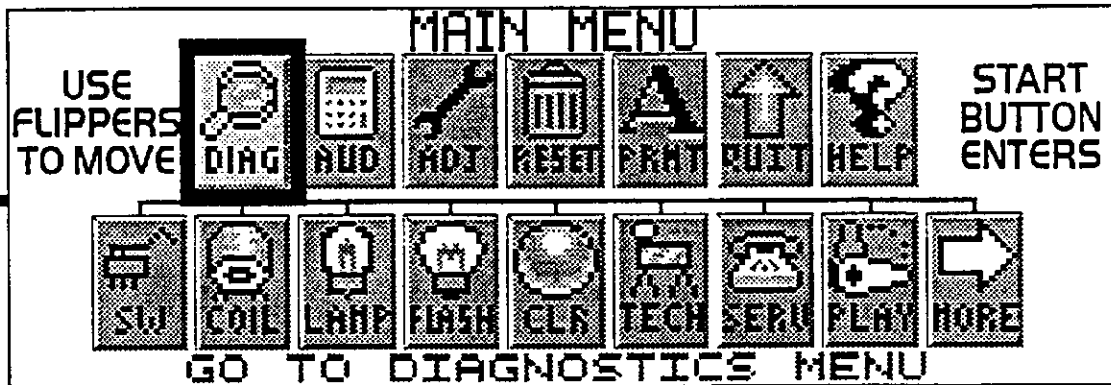

Press the Start Button to activate this ICON. This will bring up the DIAGNOSTICS MENU.

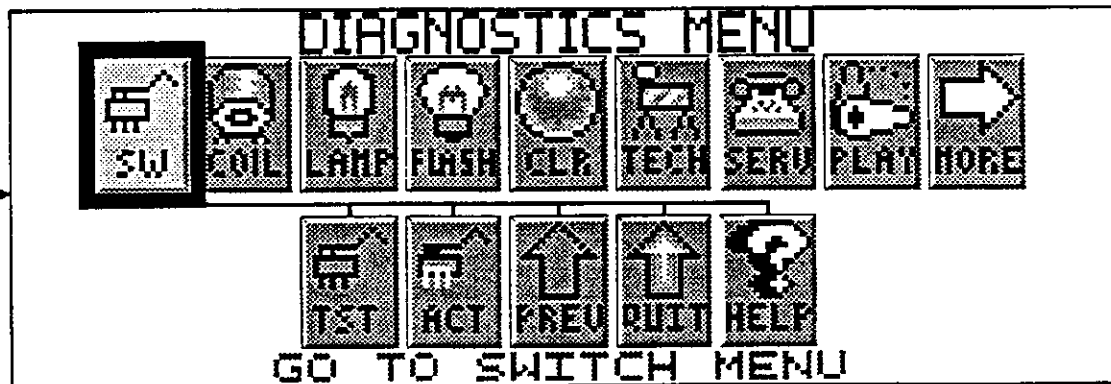

The DIAGNOSTICS MENU now appears with the "SW" *Icon* (GO TO SWITCH MENU) flashing. Press the Start Button to activate this icon. This will bring up the SWITCH TEST MENU.

The SWITCH TEST MENU now appears with the "TST" Icon (SWITCH TEST) flashing:
 Press the Start Button to activate this icon. This will bring up the Switch Test Display.



The Switch Test Display now appears. All switches can be tested one at a time.

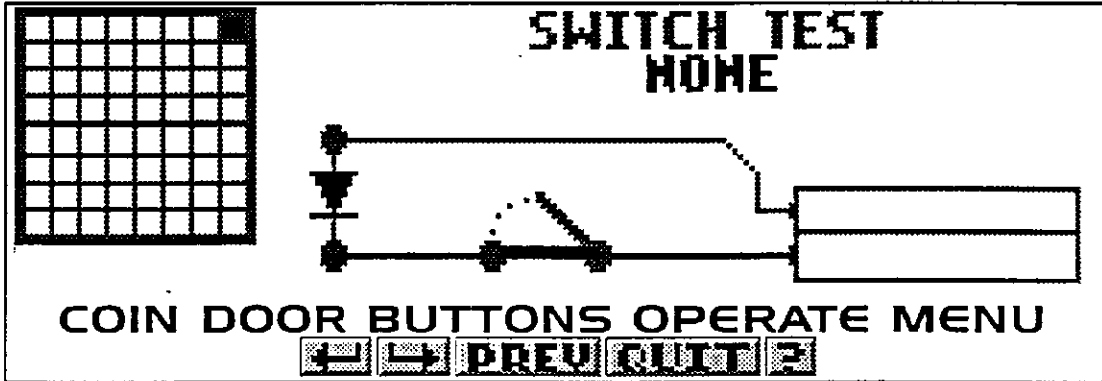

A fictitious example is shown with Switch #57 being closed:

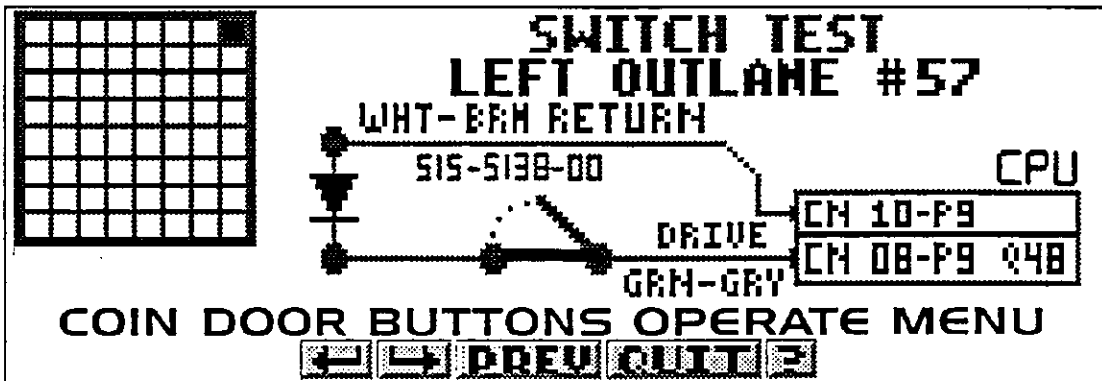

As each switch is closed, the respective Switch Matrix grid position (1-64) will be lit. In the example, the grid is lit (right corner). Under "SWITCH TEST", describes the switch in the Switch Matrix which includes the name (e.g. Left Outlane #57), the Return (Row) Wire (WHT- BRN) and the Drive (Column) Wire (GRN-GRY), drive transistor, the part number and the "Pin-Outs" from the CPU Board.

While in Switch Test or Active Switch Test, the Flipper & Start Buttons are deactivated. Use the Green "SELECT" or Black "ENTER" Buttons to select and activate the "MINI-ICONS" at the bottom of the display. In Switch Test, if the "Left Arrow" or "Right Arrow" Icon is activated, the display will go to the previous diagnostic, which is the Active Switch Test and vice versa. Use the Green "SELECT" Button to change the selected ICON to "PREV" Icon. Press the Black "ENTER" Button to go to the previous menu.

Note:
 The use of the Start & Flipper Buttons may be used again outside of the Switch & Active Switch Tests.

Exit out of the sub-menu by activating the big "PREV" Icon in the menu. This will bring up the DIAGNOSTICS MENU. The Switch Test Session is now complete. Note: Activating the "QUIT" Icon in any display will completely exit the Service Session.

Go To Diagnostics Menu

Special Note: If the *display flashes "OPEN THE COIN DOOR"* the game is indicating that memory has been corrupted. This is caused by either failure in memory (e.g. batteries are dead and/or faulty RAM) or upon installation of updated version of game code. Opening the Coin Door will initiate a *Factory Restore*, by opening the *Memory Protect Switch*. Check battery voltage at CMOS RAM with the power off.

Overview

The Portals™ Service Menu System provides tests for sounds, display, lamps, switches and solenoids. Each feature may be tested manually or automatically after entering the Portals™ Service Menu (see Chapter 1 of this section). Select the "DIAG" *Icon* from the MAIN MENU to go to the DIAGNOSTICS MENU. The automatic tests (e.g. Cycling Coils, Flash Lamps, etc.) may be used for a quick verification of automatic test functions and the manual tests (Begin Play Test, Single Lamp/All/Row/Column Tests, etc.) may be used for troubleshooting.

During game play, activation of switches and operation of coils with associated switches are monitored. If a switch is not made for 50 games, it is considered faulty. When operation of a coil should close or open a switch and does not, the coil is considered faulty. In the Attract Mode, faulty switches and coils (if any) are reported (Select the "TECH" *Icon*, Technician Alerts, from the DIAGNOSTICS MENU). Note that reporting of an unused switch does not constitute a problem and that a bad coil could mean that the associated switch requires adjustment.

Wiring to switches, solenoids and controlled lamps uses color-coded wires that basically follows a resistor color-code scheme for the eight (8) Rows ("Return" in the Switch Matrix; "Ground" in the Lamp Matrix) and eight (8) Columns ("Drive" in the Switch Matrix; "18v" in the Lamp Matrix) as seen in the Switch & Lamp Matrixes later in this chapter.

GO TO DIAGNOSTICS MENU



With the game in the Attract Mode, open the Coin Door and press the Black "BEGIN TEST" Button. Select the "DIAG" *Icon* in the MAIN MENU with either Flipper Button (upon entry of the Portals™ Service Menu, the system defaults with the selection of the "DIAG" *Icon* flashing) and press the Start Button. The DIAGNOSTICS MENU appears.



The "MORE" *Icons* are indicating that "more options" are available which don't appear in the display and which way to move the selection to view the *Icons*.



Important Notes:



Exit any sub-menu and return to the MAIN MENU by selecting & activating the "PREV" *Icons*. If no *Icons* appear in the display because of a testing function or special display (e.g. "Help"), press any button to exit.



Selecting & activating the "QUIT" *Icon* from any display will exit the Service Session.



Selecting & activating the "HELP" *Icon* from any display will show a help screen. (See chapter 7 of this section for more help.)



In Diagnostics, selecting & activating the "-" *Icons* moves test forwards/backwards.



Selecting & activating the "RUN" *Icon* repeats the test on the coil or flash lamp left off at.



Selecting & activating the "ARROW" *Icons* moves between tests in the sub-menu.

Some tests require navigation through the menu(s) and selection of the *Icons* with the Green "SELECT" and Black "ENTER" Buttons. This is required in Switch and Active Switch Tests, as the Flipper and Start Buttons are a part of the test.

In Coil Test, ensure the Power Interlock Switch is pulled out. (See *Access & Use* of Chapter 1 of this section for the location.) If the switch is not pulled out, the coils and flash lamps cannot be tested. Closing the Coin Door will automatically reset this switch. Coils and Flash Lamps are checked manually in Coil Test. To automatically check coils, go to Cycling Coils from the COIL TEST MENU. To automatically check flash lamps, go to Flash Lamp Test, from the DIAGNOSTICS MENU.

GO TO SWITCH MENU



From the DIAGNOSTICS MENU, select the "SW" *Icon* with either Flipper Button and press the Start Button. Switches are configured in an 8 x 8 Matrix of Columns (Switch Drives) and Rows (Switch Returns) with up to 64 switches possible. The Switch Test Menu consists of two parts: Switch Test and Active Switches.



Switch Test

To initiate, from the SWITCH MENU, select the "TST" *Icon* with either Flipper Button and press the Start Button. In Switch Test, close each switch and observe the display. The display will describe the switch in the Switch Matrix, which includes the switch name, Return (Row) Wire, Drive (Column) Wire, Part N^o, and the "Pin-Outs" from the CPU Board. When the switch is released, the information of the last switch closed will remain in the display until another switch is closed or the test is exited.



Active Switch Test

To initiate, from the SWITCH MENU, select the "ACT" *Icon* with either Flipper Button and press the Start Button. If still in Switch Test, select the "PREV" *Icon* to return to Switch Menu or select either of the "ARROW" *Icons* will move to Active Switch Test (selecting again will return to Switch Test). If any switches are stuck closed (or made from the presence of a pinball), the display sequences through the switch names, Return (Row) Wire, Drive (Column) Wire, drive transistor, Part N^o, and the "Pin-Outs" from the CPU Board. This cycle continues until all switches are cleared or until the test is exited.

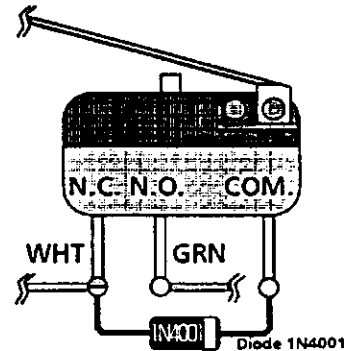
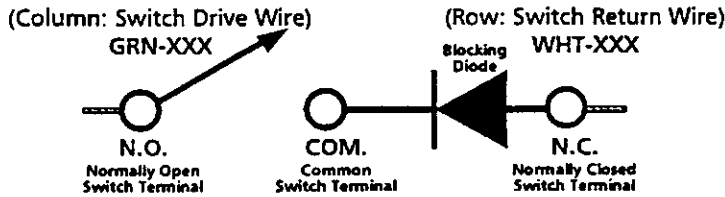

SWITCH MATRIX CHART

Column (Drive)	1 Q55 GRN-BRN CN8-1	2 Q54 GRN-RED CN8-2	3 Q53 GRN-ORG CN8-3	4 Q52 GRN-YEL CN8-4	5 Q51 GRN-BLK CN8-5	6 Q50 GRN-BLU CN8-7	7 Q49 GRN-VIO CN8-8	8 Q48 GRN-GRY CN8-9	
Row (Return)	1 WHT-BRN CN10-9	PLUMB BOB TILT 1	NOT USED 9	NOT USED 17	LEFT RAMP -LEFT "?" 25	LASER KICK LEFT OUTLANE 33	TOP EJECT 41	GUN TRIGGER (AUTO LAUNCH) 49	TURBO BUMPER LEFT 57
2 WHT-RED CN10-8	4TH COIN SLOT 2	NOT USED 10	LEFT 4-BANK DROP TARGET BOTTOM 18	LEFT RAMP -RIGHT "?" 26	LEFT RETURN LANE 34	TOP GOOD HEADS STAND-UP 42	RIGHT GOOD HEADS STAND-UP 50	TURBO BUMPER BOTTOM 58	
3 WHT-ORG CN10-7	START BUTTON 3	#1 BALL TROUGH (LEFT) 11	LEFT 4-BANK DROP TARGET MID. BOT. 19	VUK "?" 27	LEFT SLINGSHOT 35	TOP BAD HEADS STAND-UP 43	RIGHT BAD HEADS STAND-UP 51	TURBO BUMPER RIGHT 59	
4 WHT-YEL CN10-6	RIGHT COIN SLOT 4	#2 BALL TROUGH 12	LEFT 4-BANK DROP TARGET MID. TOP 20	RIGHT RAMP -LEFT STAND-UP 28	RIGHT SLINGSHOT 36	BATWING LOADED 44	LEFT RAMP ENTER 52	LOCK 3 TOP 60	
5 WHT-GRN CN10-5	CENTER COIN SLOT 5	#3 BALL TROUGH 13	LEFT 4-BANK DROP TARGET TOP 21	RIGHT RAMP -RIGHT "?" 29	RIGHT RETURN LANE INSIDE 37	BATWING LOCATION 45	LEFT RAMP EXIT 53	LOCK 2 MIDDLE 61	
6 WHT-BLU CN10-3	LEFT COIN SLOT 6	#4 BALL TROUGH (RIGHT) 14	TOP LANE LEFT 22	BAT CAVE EXIT KICKER 30	RIGHT RETURN LANE OUTSIDE 38	BATWING HOME 46	MIDDLE RAMP EXIT 54	LOCK 1 BOTTOM 62	
7 WHT-VIO CN10-2	SLAM TILT 7	4-BALL TROUGH VUK OPTO 15	TOP LANE MIDDLE 23	NOT USED 31	RIGHT OUTLANE 39	LEFT ORBIT 47	RIGHT RAMP ENTER 55	LT FLIPPER BUTTON VIA Q7, ON SSFB X2 63	
8 WHT-GRY CN10-1	EXTRA BALL BUY-IN/ LEAGUE BUTTON 8	SHOOTER LANE 16	TOP LANE RIGHT 24	VUK 32	U-TURN RAMP 40	RIGHT ORBIT 48	RIGHT RAMP EXIT 56	RT FLIPPER BUTTON VIA Q5, ON SSFB X2 64	

Switch Matrix Descriptions with Part Numbers and Locations †

The switch locations correspond with the Switch N° in the table below and the Switch Maxtrix Chart.

Playfield Switch Locations

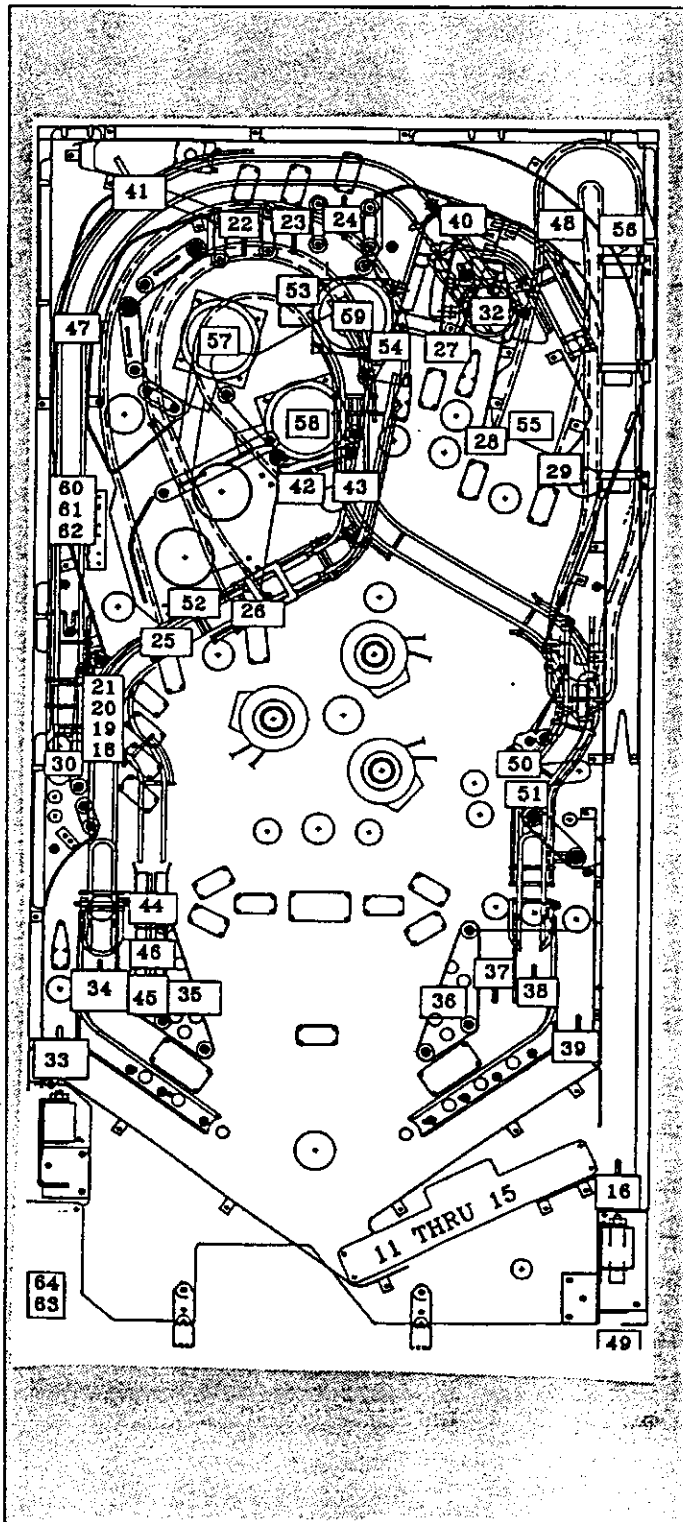

Notes:

† Specify Game N° 38 for Game Specific Switches, if any.

* Switch location is in or on cabinet.

Sw. N°	Col. N°	Row N°	Switch Matrix Description	Part N°
1	1	1	* PLUMB BOB TILT (See Section 4, Chapter 1)	
2	1	2	* 4TH COIN SLOT (On Coin Door)	
3	1	3	* START BUTTON (Left of Coin Door)	500-5097-02
4	1	4	* RIGHT COIN SLOT (On Coin Door)	180-5024-00
5	1	5	* CENTER COIN SLOT (On Coin Door)	180-5024-00
6	1	6	* LEFT COIN SLOT (On Coin Door)	180-5024-00
7	1	7	* SLAM TILT	180-5022-00
8	1	8	* EXTRA BALL BUYIN/LEAGUE BUTTON	180-5073-00
9	2	1	NOT USED	
10	2	2	NOT USED	
11	2	3	#1 BALL TROUGH (LEFT)	180-5119-00
12	2	4	#2 BALL TROUGH	180-5119-00
13	2	5	#3 BALL TROUGH	180-5119-00
14	2	6	#4 BALL TROUGH	180-5119-00
15	2	7	#4 BALL TROUGH VUK OPTO (TRANS) (REQ)	520-512400 520-5125-00
16	2	8	SHOOTER LANE	500-5707-00
17	3	1	NOT USED	
18	3	2	LEFT 4-BANK DROP TARGET BOTTOM	
19	3	3	LEFT 4-BANK DROP TARGET MID. BOT.	
20	3	4	LEFT 4-BANK DROP TARGET MID. TOP	
21	3	5	LEFT 4-BANK DROP TARGET TOP	
22	3	6	TOP LANE LEFT	
23	3	7	TOP LANE MIDDLE	
24	3	8	TOP LANE RIGHT	
25	4	1	LEFT RAMP - LEFT *?	
26	4	2	LEFT RAMP - RIGHT *?	
27	4	3	VUK *?	
28	4	4	RIGHT RAMP - LEFT STAND-UP	
29	4	5	RIGHT RAMP - RIGHT *?	
30	4	6	BAT CAVE EXIT KICKER	
31	4	7	NOT USED	
32	4	8	VUK	
33	5	1	LASER KICK LEFT OUTLANE	
34	5	2	LEFT RETURN LANE	
35	5	3	LEFT SLINGSHOT	
36	5	4	RIGHT SLINGSHOT	
37	5	5	RIGHT RETURN LANE INSIDE	
38	5	6	RIGHT RETURN LANE OUTSIDE	
39	5	7	RIGHT OUTLANE	
40	5	8	U-TURN RAMP	
41	6	1	TOP EJECT	
42	6	2	TOP GOOD HEADS STAND-UP	
43	6	3	TOP BAD HEADS STAND-UP	
44	6	4	BATWING LOADED	
45	6	5	BATWING LOCATION	
46	6	6	BATWING HOME	
47	6	7	LEFT ORBIT	
48	6	8	RIGHT ORBIT	
49	7	1	GUN TRIGGER (AUTO LAUNCH)	
50	7	2	RIGHT GOOD HEADS STAND-UP	
51	7	3	RIGHT BAD HEADS STAND-UP	
52	7	4	LEFT RAMP ENTER	
53	7	5	LEFT RAMP EXIT	
54	7	6	MIDDLE RAMP EXIT	
55	7	7	RIGHT RAMP ENTER	
56	7	8	RIGHT RAMP EXIT	
57	8	1	TURBO BUMPER LEFT	
58	8	2	TURBO BUMPER BOTTOM	
59	8	3	TURBO BUMPER RIGHT	
60	8	4	LOCK 3 TOP	
61	8	5	LOCK 2 MIDDLE	
62	8	6	LOCK 1 BOTTOM	
63	8	7	LOWER LEFT FLIPPER SWITCH STACK	180-5122-00
64	8	8	UPPER & LOWER RIGHT FLIPPER SWITCH STACK	180-5122-00

Section 3 | Diags.



GO TO COIL MENU

From the **DIAGNOSTICS MENU**, select the **"COIL" Icon** with either **Flipper Button** and press the **Start Button**. Twenty-Two regular coil drivers (pulsed under microprocessor control) are provided to switch ground to coils. The **Left/Right Relay** is used in conjunction with **Drives 1 through 8** to switch **+32/50 volts** between coils or flash lamps; these sets are termed **"left"** and **"right"**. The first 8 coil numbers are followed by **"L"** for left; the first 8 flash lamp numbers are followed by **"R"**. This relay is located on the **PPB Board** which provides isolation diodes and current limiting resistors. This effectively provides up to 30 drive controlled devices. The remaining (9-22) can be either coils or flashlamps (indicated in the display and the tables below).



Coil Test

To initiate, from the **COIL MENU**, select the **"TST" Icon** with either **Flipper Button** and press the **Start Button**. Ensure the **Power Interlock Switch** is pulled out. Select either the **"-"** or **"+" Icons**. Start with the **"+" Icon** to start the manual Coil Test from **#1L** (The test runs through **#1L - 22**). Press the **Start Button** on the **"+" Icon**, as each coil is selected, the display will describe the coil or flash lamp name with the corresponding number, the wire with colors, the **"Pin-Outs"** from the **CPU & PPB Boards**, the coil voltage and gauge/turns (coils only). Press the **Start Button** again to move forward in the test. To test and view a particular coil or flash lamp, select the **"RUN" Icon** and press the **Start Button**. Each time the **Start Button** is pushed, the coil or flash lamp will fire on the playfield and/or backbox, with the display indicating the coil or flash lamp information. Continue with the same procedure to run through the entire test.



Cycling Coil Test

To initiate, from the **COIL MENU**, select the **"CYC" Icon** with either **Flipper Button** and press the **Start Button**. If still in **Coil Test**, select the **"PREV" Icon** to return to **Coil Menu** or select either of the **"ARROW" Icons** will move to **Cycling Coil Test** (selecting again will return to **Coil Test**). The test pulses each regular solenoid or flash lamp sequentially (cycling) on the playfield and backbox. The display indicates **"CYCLING COILS"**.

Backbox Flash Lamp Locations

Below are the flash lamp locations in the backbox (General Illumination (G.I.s) Lamps are also shown but are not a part of the Coil Test). The flash lamp locations correspond with the solenoid numbers as seen in **Coil Test**. The table below indicates the numbers for the flash lamps in the backbox.

Backbox (Insert) Flash Lamps & G.I.s

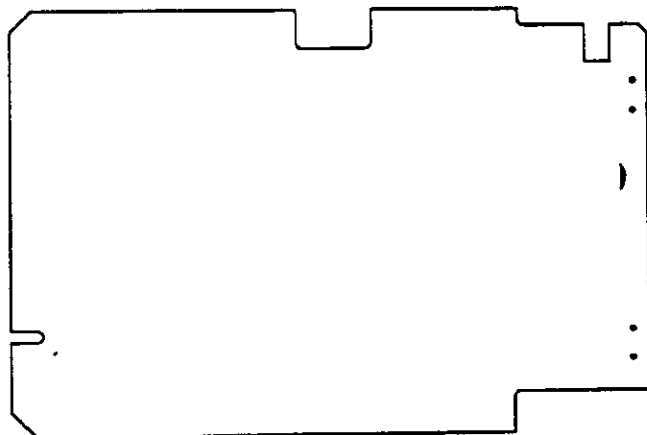

Solenoid N ^o	Type	Solenoid Description (Flash Lamps)
1L	Coil	4-Ball Trough Lock Ball
1R	Flash	4-Bank x2 Left Bottom x2
2L	Coil	Trough Up-Kicker
2R	Flash	Left Ramp X4
3L	Coil	Auto Ball Launch 50v
3R	Flash	Left Orbit X4
4L	Coil	VUK 50v
4R	Flash	Top Left Corner X2 Bankpanel X1 Insert X1
5L	Coil	Top Eject
5R	Flash	2-Bank Stand-Up X1 Bankpanel X1 Insert X2
6L	Coil	NOT USED
6R	Flash	U-Turn X1 Backpanel X1 Insert X2
7L	Coil	4-Bank Drop Target Reset
7R	Flash	Top Right X2 Backpanel X1 Insert X1
8L	Coil	Knocker 32v
8R	Flash	Right Bottom X2 Right Stand-Up X1 Insert X1

The next page show all the solenoid numbers as seen in the **Coil Test**, indicating the **Playfield Locations**.

Playfield Flash Lamp Locations

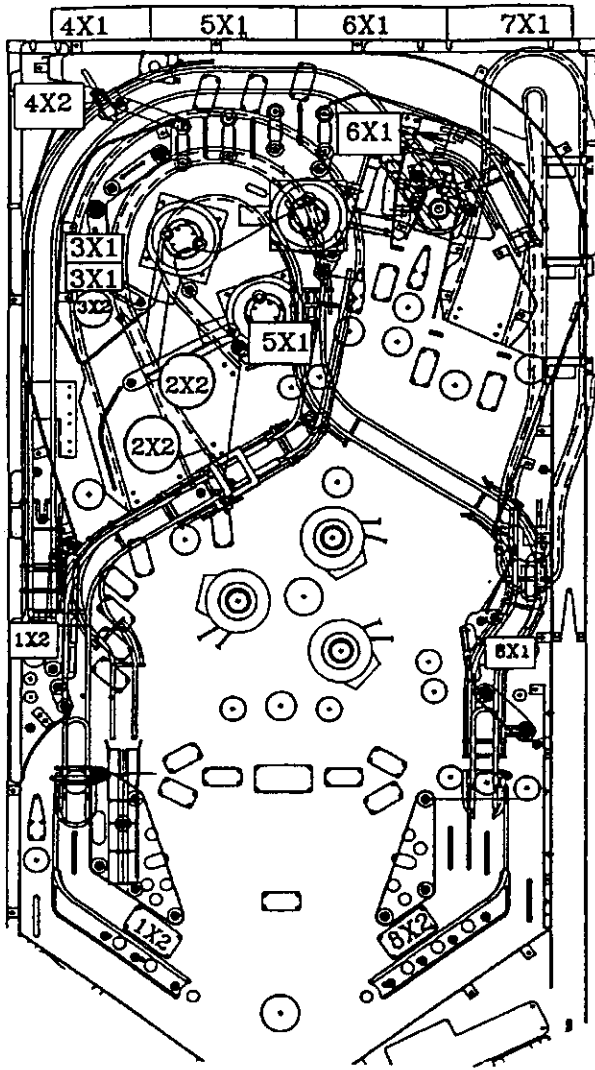

Playfield Coil Locations

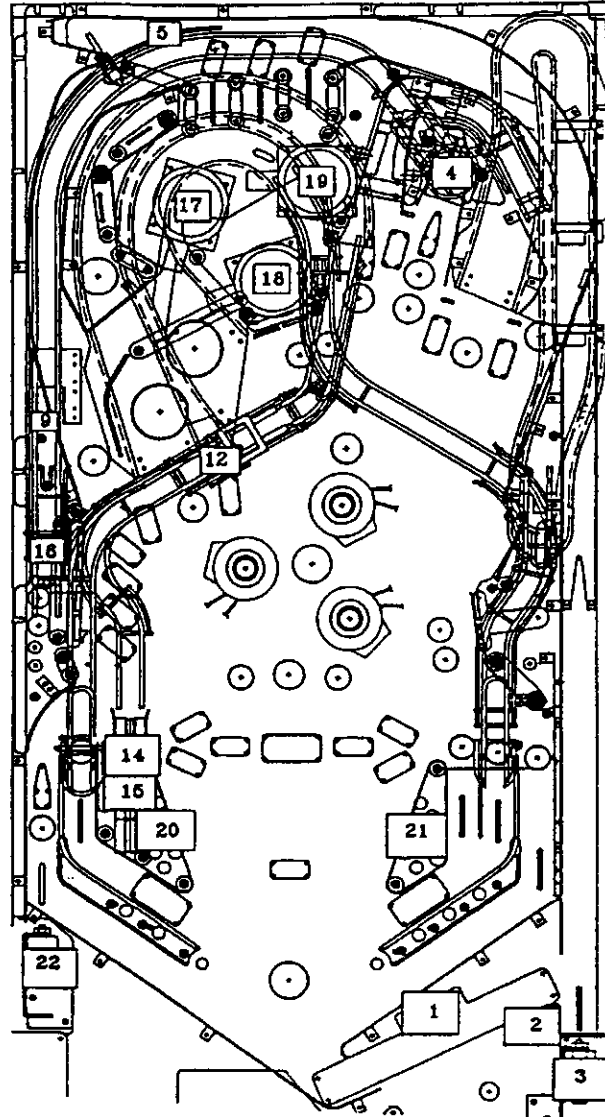

Solenoid No	Type	Solenoid Description (Coils)
1L	Coil	4-Ball Trough Lock Ball
1R	Flash	4-Bank x2 Left Bottom x2
2L	Coil	Trough Up-Kicker
2R	Flash	Left Ramp X4
3L	Coil	Auto Ball Launch 50v
3R	Flash	Left Orbit X4
4L	Coil	VUK 50v
4R	Flash	Top Left Corner X2 Bankpanel X1 Insert X1
5L	Coil	Top Eject
5R	Flash	2-Bank Stand-Up X1 Bankpanel X1 Insert X2
6L	Coil	NOT USED
6R	Flash	U-Turn X1 Backpanel X1 Insert X2
7L	Coil	4-Bank Drop Target Reset
7R	Flash	Top Right X2 Backpanel X1 Insert X1
8L	Coil	Knocker 32v
8R	Flash	Right Bottom X2 Right Stand-Up X1 Insert X1

Solenoid No	Type	Solenoid Description
9	Coil	Bat Cave Ball Lock
10	Relay	Left/ Right (A/B) Relay
11	Relay	G.L. (General Illumination) Relay
12	Coil	Batwing Ramp Diverter
13	Coil	NOT USED
14	Coil	Batwing Motor Relay
15	Coil	Batwing Cannon Ball Launch 50v
16	Coil	Bat Cave Exit Kicker 50v
17	Coil	Left Turbo Bumper
18	Coil	Bottom Turbo Bumper
19	Coil	Right Turbo Bumper
20	Coil	Left Slingshot
21	Coil	Right Slingshot
22	Coil	Laser Kick 50v

Note 1: White rows=Flash Lamps, Black Rows=Coils
 Note 2: Gray areas are not seen in the Dot Matrix Display.



More Information with Coil Test

The following 2 pages describe in detail both coils & flash lamps in the "Switch, CPU Controlled Auxillary & Constant Power Solenoids" Table and the "Flipper Solenoids" Table. After these tables, is the Coil Chart Schematic. For more information, see Section 6 (Yellow), Chapter 1 & 2 for Schematics & Troubleshooting.



GO TO LAMP MENU

From the DIAGNOSTICS MENU, select the "LAMP" *Icon* with either Flipper Button and press the Start Button. Controlled lamps are configured in an 8 x 8 Matrix of Columns (Lamp Drives) and Rows (Lamp Returns) with up to 64 lamps possible. The Lamp Test Menu consists of four parts: Single Lamp Test, Test All Lamps, Row Lamp Test and Column Lamp Test.



Single Lamp Test

To initiate, from the LAMP MENU, select the "ONE" *Icon* with either Flipper Button and press the Start Button. Select either the "-" or "+" *Icons*. Start with the "+" *Icon* to start the manual Lamp Test from Column 1, Row 1, Switch 1. Press the Start Button on the "+" *Icon*, as each lamp is selected, the lamp will light at it's location on the playfield as well as the display, indicating the Lamp Matrix Grid Position, lamp name with the corresponding number, Return (Row) Wire & Color, Drive (Column) Wire & Color, and drive transistors. Press the Start Button again to move forward in the test. To test and view a particular lamp, select the "RUN" *Icon* and press the Start Button. Each time the Start Button is pushed, the lamp will light-up on the playfield, with the display indicating the lamp information. Continue with the same procedure to run through the entire test.



Test All Lamps

To initiate, from the LAMP MENU, select the "ALL" *Icon* with either Flipper Button and press the Start Button. If still in Single Lamp Test (or any 1 of the 4 tests), select the "PREV" *Icon* to return to Lamp Menu or select either of the "ARROW" *Icons* will move through the tests, keep activating until Test All Lamps is displayed. The display will indicate "ALL LAMPS ON" and the lamps on the playfield will be lit, alternating between the rows in the Lamp Matrix.



Row Lamp Test

To initiate, from the LAMP MENU, select the "ROW" *Icon* with either Flipper Button and press the Start Button. If still in Test All Lamps (or any 1 of the 4 tests), select the "PREV" *Icon* to return to Lamp Menu or select either of the "ARROW" *Icons* will move through the tests, keep activating until Row Lamp Test is displayed. In this test, each set of lamps in each row of the Lamp Matrix will light-up on the playfield and is indicated in the display.

Go to Lamp Menu is continued on the next page with Column Lamp Test.

LAMP MATRIX CHART

Column (18v)	1 Q71 YEL-BRN CN7-1	2 Q70 YEL-RED CN7-2	3 Q69 YEL-ORG CN7-3	4 Q68 YEL-BLK CN7-4	5 Q67 YEL-GRN CN7-5	6 Q66 YEL-BLU CN7-7	7 Q65 YEL-VIO CN7-8	8 Q64 YEL-GRY CN7-9
Row (GND)	1 Q72 RED-BRN CN6-1	2 Q73 RED-BLK CN6-2	3 Q74 RED-ORG CN6-3	4 Q75 RED-YEL CN6-5	5 Q76 RED-GRN CN6-6	6 Q77 RED-BLU CN6-7	7 Q78 RED-VIO CN6-8	8 Q79 RED-GRY CN6-9
1	ROOF TOP CHASE 1	TOP LANE LEFT "B" 9	MAGNETS ON 17	MR. E 25	TOP LOCK (LOCK 2) 33	TOP "GOOD" HEADS (LEFT) 41	LT. RAMP ENTER ARM BATWING (LEFT) 49	TURBO BUMPER LEFT 57
2	???????	TOP LANE MIDDLE "A" 10	LEFT 4-BANK BOTTOM 18	LEFT ORBIT BAT 26	BOTTOM LOCK (LOCK 1) 34	TOP "BAD" HEADS (RIGHT) 42	LT. RAMP ENTER JACKPOT (RIGHT) 50	TURBO BUMPER BOTTOM 58
3	FACE TWO FACE 3	TOP LANE RIGHT "T" 11	LEFT 4-BANK MID. BOT. 19	LEFT RAMP BAT 27	SUPER JACKPOT 35	RT. "GOOD" HEADS (TOP) 43	MIDDLE RAMP DOUBLE JACKPOT 51	TURBO BUMPER RIGHT 59
4	CRIME STREET (GRID) 4	LEFT RAMP LEFT "I" 12	LEFT 4-BANK MID. TOP 20	MIDDLE RAMP BAT 28	NOT USED 36	RIGHT "BAD" HEADS (BOTTOM) 44	RIGHT RAMP ENTER (LEFT) CRIME SPREE 52	NOT USED 60
5	BRAIN DRAIN 5	LEFT RAMP RIGHT "I" 13	LEFT 4-BANK TOP 21	U-TURN RAMP BAT 29	NOT USED 37	LASER KICK 45	RIGHT RAMP ENTER JACKPOT (RIGHT) 53	BATWING LAMP 61
6	SAFE TRAP 6	VUK "I" 14	BAT (GRID) 22	RIGHT RAMP BAT 30	NOT USED 38	RIGHT RETURN LANE INSIDE 46	EXTRA BALL 54	BATMAN RETURNS 62
7	LITE EXTRA BALL (GRID) 7	RIGHT RAMP LEFT "I" 15	GOOD HEADS (GRID) 23	RIGHT ORBIT BAT 31	LEFT RETURN LANE 39	RIGHT RETURN LANE OUTSIDE 47	LOCK ARROW 55	EXTRA BALL BUY-IN/ LEAGUE BUTTON 63
8	FOREVER 8	RIGHT RAMP RIGHT "I" 16	BAD HEADS (GRID) 24	VUK BAT 32	LEFT OUTLANE (SPECIAL) 40	RIGHT OUTLANE (SPECIAL) 48	GOTHAM EVENT 56	START BUTTON 64



Column Lamp Test

To initiate, from the LAMP MENU, select the "COL" Icon with either Flipper Button and press the Start Button. If still in Row Lamp Test (or any 1 of the 4 tests), select the "PREV" Icon to return to Lamp Menu or select either of the "ARROW" Icons will move through the tests, keep activating until Column Lamp Test is displayed. In this test, each set of lamps in each column of the Lamp Matrix will light-up on the playfield and is indicated in the display.

Lamp Matrix Location

The lamp locations correspond with the Lamp Number in the Lamp Maxtrix Chart on the Previous page.

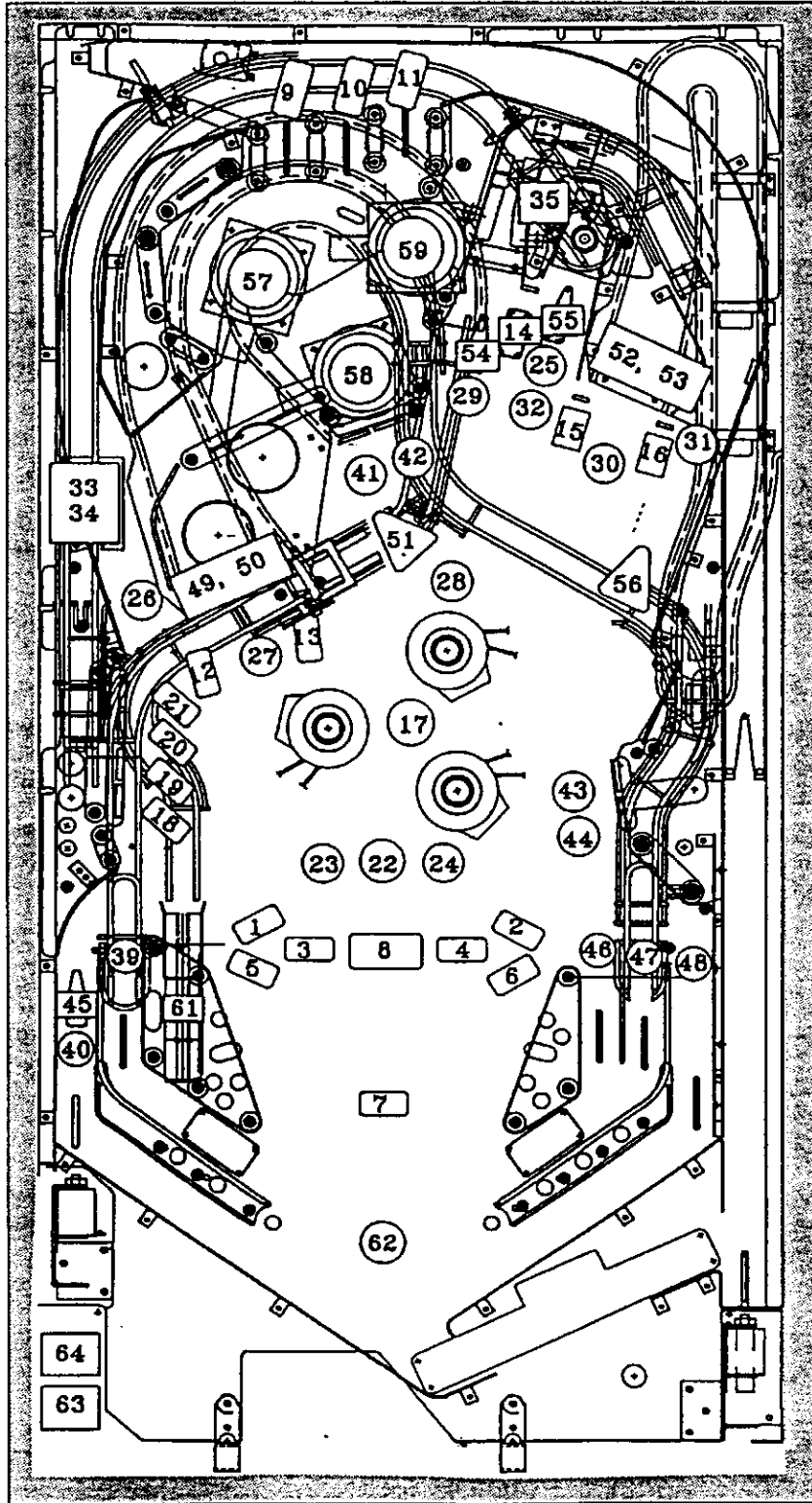



TEST FLASH LAMPS

From the DIAGNOSTICS MENU, select the "FLASH" *Icon* with either Flipper Button and press the Start Button. After selecting this *Icon* the display will indicated "CYCLING FLASHERS" and all the flash lamps will cycle continuously until the test is exited. This test is allows the technician to easily spot any burned-out bulbs and replace them. Note: This test is also good to verify operation of the Left/Right Relay. If the relay does not function properly, coils will energize instead of the flash lamps.



CLEAR BALL TROUGH

From the DIAGNOSTICS MENU, select the "CLR" *Icon* with either Flipper Button and press the Start Button. This is provided to allow the technician a simple method of removing the balls from the trough and also, to test functionality of the trough, ensuring proper trough operation. After selecting this *Icon* the display will show a graphic of the ball trough and show any balls in the trough with it's corresponding switch number. Select the "RUN" *Icon* to eject the ball in the first position. Simultaneously, the display and the playfield will eject the ball to the Trough Up-Kicker, eject from the Trough Up-Kicker into the Shooter Lane and will be ejected onto the playfield where the technician can easily retrieve the pinball. Repeat this procedure until all balls desired are ejected.



TECHNICIANS ALERTS

From the DIAGNOSTICS MENU, select the "TECH" *Icon* with either Flipper Button and press the Start Button. After selecting this *Icon* the display will indicate if there are any faulty switches (i.e., switches that are normally closed but remain open or open switches that have not been closed (activated) in 50 games.)



SERVICE PHONE

From the DIAGNOSTICS MENU, select the "SERV" *Icon* with either Flipper Button and press the Start Button. After selecting this *Icon* the display will indicate the toll-free phone number to call if technical assistance is required (1-800-KICKERS).



BEGIN PLAY TEST

From the DIAGNOSTICS MENU, select the "PLAY" *Icon* with either Flipper Button and press the Start Button. After selecting this *Icon* the technician can test certain play functions to insure all switch activated coils function without entering game play. For example, by rolling the ball over the left outlane switch, the Laser Kick should fire. If it kicks to early or too late, the switch actuator should be adjusted to compensate for this error. If it fails to fire, use the Switch Test or Coil Test to help determine the cause of the failure. During this function, similar tests may be performed on the Vertical Up-Kickers, Ejects, Pop Bumpers, etc. in the game. For unique Play Test functions, see the "GAME SPECIFIC" *Icon* in the DIAGNOSTICS MENU.



SOUND/SPEAKER TEST

From the DIAGNOSTICS MENU, select the "SPKR" *Icon* with either Flipper Button and press the Start Button. The BSMT 2000 Sound System produces true digital stereo sound on the Left & Right Speakers and "Mono" on the Center Speaker. After selecting this *Icon*, select the "-" or "+" *Icons* and press the Start Button to activate the first test. Repeat to visually see & hear all tests. Select the "RUN" *Icon* to activate the test chosen without moving to the next test.

During Sound Tests, the display shows the sound board circuit under test and the correspond- ing sounds. The sound functions allow verification that all channels are functioning properly & that the speaker connections are correct. (Refer to the game manual for detailed testing procedures).

Automatic / Manual Tests	Sounds Produced
Left Speaker	Left Sine
Both Left & Right Speakers	Center Sine
Right Speaker	Right Sine
Voice Rom 1 (Loc. U17)	Speech Pattern 1

Automatic / Manual Tests	Sounds Produced
Voice Rom 2 (Loc. U21)	Speech Pattern 2
Voice Rom 3 (Loc. U36)	Speech Pattern 3
Music Test (Sound Rom, Loc. U7)	Level 1-3 Music

Speaker Phase Testing



Connections to each of the three speakers are polarized and each must be connected appropriately for the best quality sound. If one speaker has the positive and negative connections reversed with respect to the other two, bass frequencies will not be produced properly and the overall sound quality will be poor.

To test for proper speaker phasing, use the sound test to cycle through the Left, Center, and Right Sine functions. If the Center Sine produces more volume and bass than the Left and Right Sines, the speakers are connected properly. If it produces the same or less, one speaker is connected improperly. To isolate and correct reversed speaker connections, one of two methods may be used.

1. Check each speaker for polarity markings. If the speakers have polarity markings, verify that the single-color wire (BLK, YEL or RED) is connected to the negative (-) terminal.
2. Disconnect the speaker output connector from the Sound Board and connect a 1.5-volt battery across each speaker pair one at a time while observing the speakers. Make sure the positive battery terminal is connected to the positive lead (CN1- Pin 1, 3 or 6) each time. As the connection is made, check speaker cone movement; proper connections are indicated by outward movement.



BEGIN BURN IN

From the DIAGNOSTICS MENU, select the "BURN" *Icon* with either Flipper Button and press the Start Button. After selecting this *Icon* the Begin Burn-In Test will start. At this stage the game will exercise all CPU I/O Functions (Dot Matrix Display Test, Coil Testing, Lamp Testing, Sound, etc). This is provided to constantly exercise sounds, solenoids, etc... Cumulative Burn-In minutes will be displayed. To reset Burn-In minutes to 00, select the "RESET" *Icon* in the MAIN MENU and select the "FACT" *Icon* (Factory Restore). See Chapter 5, Go To Reset Menu, of this section.



DOT MATRIX TEST

From the DIAGNOSTICS MENU, select the "DOT TEST" *Icon* with either Flipper Button and press the Start Button. After selecting this *Icon* the Dot Matrix Display Test immediately begins. The display will immediately illuminate cycling for one pass of each test. A. Illuminates 1 vertical column of dots, turning it off & illuminating the next column, until each column has been individually lit, while the other columns are off. B. Illuminates 1 horizontal row of dots, turning it off & illuminating the next row, until each row has been individually lit, while the other rows are off. C. Illuminates all the dots, except for one column from left to right. D. Illuminates all the dots except for one row from top to bottom. E. Illuminate every other dot lit, in both the rows and columns. F. Illuminate all dots at 30%, 70% & 100% brightness. The test will repeat these cycles indefinitely until any button is pressed. Pressing any button will exit the test and return to DIAGNOSTICS MENU.

Dot Matrix Display Explained

The display utilizes a Micro-Processor Control Board mounted in piggyback fashion to the Dot Matrix Display Driver Board. The purpose behind this board is to provide more information (192 X 64 Dots) to the operator as well as displaying graphics to the player.

The board is controlled by a 68000 Microprocessor and its personality ROMs (Unique to the Game). It receives Data, Reset & Clock Information from the CPU Board via the ribbon cable and sends back multiple Status and Busy Signals to the CPU. This is to insure synchronized communication between the CPU and the Display Controller Board.

The Drivers for the rows and columns are provided on 5 surface mounted integrated circuits on the Dot Matrix Display Driver Board.



BATMAN FOREVER GAME SPECIFIC

From the DIAGNOSTICS MENU, select the "BAT" *Icon* with either Flipper Button and press the Start Button. After selecting this *Icon* the technician can test and adjust any game specific function(s). Similar to "BEGIN PLAY TEST", this menu is used to customize a game specific feature. The feature is:

All other coils can be tested as well.



BATMAN[®] FOREVER GAME AUDIT TABLE



Photocopy for Field Audit Tracking Performance (Use blank column to fill-in game audit totals)



EARNINGS AUDITS 1-12

Nº	Audit Name	Fill-In
1	TOTAL PAID CREDITS	
2	FREE GAME PERCENTAGE	
3	AVERAGE BALL TIME	
4	AVERAGE GAME TIME	
5	COINS THRU LEFT SLOT	
6	COINS THRU RIGHT SLOT	
7	COINS THRU CENTER SLOT	
8	COINS THRU 4TH SLOT	
9	TOTAL COINS	
10	TOTAL EARNINGS	
11	METER CLICKS	
12	SOFTWARE METER	



SEGA AUDITS 13-46

Nº	Audit Name	Fill-In
13	TOTAL BALLS PLAYED	
14	TOTAL EXTRA BALLS	
15	EXTRA BALL PERCENT	
16	REPLAY 1 AWARDS	
17	REPLAY 2+ AWARDS	
18	TOTAL REPLAYS	
19	REPLAY PERCENT	
20	TOTAL SPECIALS	
21	SPECIAL PERCENT	
22	TOTAL MATCHES	
23	HIGH SCORE AWARDS	
24	HIGH SCORE PERCENT	
25	TOTAL FREE PLAYS	
26	TOTAL PLAYS	
27	0.0M TO 99.9M	
28	100.0M TO 199.9M	



SEGA AUDITS 13-46

Nº	Audit Name	Fill-In
29	200.0M TO 399.9M	
30	400.0M TO 799.9M	
31	800.0M TO 1.19B	
32	1.2B+ SCORES	
33	AVERAGE SCORES	
34	SERVICE CREDITS	
35	PROPRIETARY	
36	PROPRIETARY	
37	PROPRIETARY	
38	TOTAL BUYIN GAMES	
39	TOTAL EXTRA BALL BUYINS	
40	EXTRA BALL BUYIN REPLAYS	
41	EXTRA BALL BUYIN HSTDS	
42	LEFT DRAINS	
43	CENTER DRAINS	
44	RIGHT DRAINS	
45	TOTAL SLAM TILTS	
46	TOTAL BALLS SAVED	



BATMAN FOREVER AUDITS 47-XX

Nº	Audit Name	Fill-In
47	SKILL SHOT-LITE LOCK	
48	SKILL SHOT-MYSTERY	
49	SKILL SHOT-START GOTHAM EVENT	
50	SKILL SHOT-SUPER POPS	
51	TOP LANES COMPLETED	
52	LEFT RAMP SHOTS	
53	CENTER RAMP SHOTS	
54	U-TURN MINIRAMP SHOTS	
55	RIGHT RAMP SHOTS	
56	4-BANK COMPLETED	
57	MYSTERY LIT FROM U-TURN	
58	MYSTERY COLLECTED	



BATMAN FOREVER AUDITS 47-XX

Nº	Audit Name	Fill-In
59	VUK SHOTS	
60	LASER KICK LIT	
61	LASER KICK USED	
62	BATARANG ORBITS COMPLETED	
63	2X BATARANG ORBITS	
64	ARM BATWING LIT	
65	2X BATWING HITS	
66	BATWING CANNON FIRED	
67	BATWING SCORE DOUBLED	
68	BATWING TARGETS COMPLETED	
69	HURRYUP EXTRA BALL SCORED	
70	4-WAY COMBOS	
71	BATSCREECH AWARDED	
72	ROOFTOP CHASE STARTED	
73	"???????" STARTED	
74	FACE TWO-FACE STARTED	
75	CRIME SPREE STARTED	
76	BRAIN DRAIN STARTED	
77	BRAIN DRAIN RESTARTED	
78	SAFE TRAP STARTED	
79	LITE EB (GRID) STARTED	
80	ROVING BAT SIGNALS COM.	
81	GOOD SIDE COINS COM.	
82	BAD SIDE COINS FEATURE	
83	MISMATCHED COINS FEATURE	
84	FOREVER MODE STARTED	
85	FOREVER JACKPOTS SCORED	
86	LOCK 1 COLLECTED	
87	LOCK 2 COLLECTED	
88	MULTIBALL READY	
89	MULTIBALL START (3-BALL)	
90	MULTIBALL START (4-BALL)	
91	MULTIBALL RESTART	
92	2+ MULTIBALL START	
93	TOTAL LEFT RAMP JACKPOTS	
94	TOTAL RIGHT RAMP JACKPOTS	
95	TOTAL DOUBLE JACKPOTS	
96	TOTAL SUPER JACKPOTS	

Go To Audits Menu

Overview

The Portals™ Service Menu System provides 81 Audit Functions for accounting purposes and for evaluation of game difficulty adjustments. The Audit Functions are split into 3 groups. The first group, Earnings Audits, are the first 12 most-used audits. The second group, Sega Audits, are the game play generic audits (13-46). The last group, Batman Forever Audits, are the game play specific audits (47-7). Each group may be viewed manually after entering the Portals™ Service Menu (see Chapter 1, Introduction, of this section). All audits can be viewed at a glance with the Game Audit Table provided on the previous page.

GO TO AUDITS MENU



With the game in the Attract Mode, open the Coin Door and press the Black "BEGIN TEST" Button. Select the "AUD" Icon in the MAIN MENU with either Flipper Button and press the Start Button. The AUDITS MENU appears.

Important Notes:



Exit any sub-menu and return to the MAIN MENU by selecting & activating the "PREV" Icons. If no Icons appear in the display because of a testing function or special display (e.g. "Help"), press any button to exit.



Selecting & activating the "QUIT" Icon from any display will exit the Service Session.



Selecting & activating the "HELP" Icon from any display will show a help screen. (See chapter 7 of this section for more help.)



Selecting & activating the "ARROW" Icons selects the next or previous audit in the group.

EARNINGS AUDITS (1-12)



From the AUDITS MENU, select the "EARN" Icon with either Flipper Button and press the Start Button. Select and activate the "RIGHT ARROW" Icon to view the 1st audit in this group. Continue to select either of the "ARROW" Icons to view each audit one at a time. The display will describe the audit number, the audit name, and the audit total or value. The current audit will remain in the display until the next audit is chosen or when the sub-menu is exited.

Au. No	Audit Name	Audit Definition
Au. 1	Total Paid Credits	Provides the total number of paid credits.
Au. 2	Free Game Percentage	This percentage is derived from dividing Audit 25, Total Free Plays, by Audit 26, Total Plays.
Au. 3	Average Ball Time	In seconds, the average ball time is derived from the total play time divided by Audit 13, Total Balls Played.
Au. 4	Average Game Time	The average game time is expressed in minutes and seconds.
Au. 5	Coins Thru Left Slot	Provides the total amount of coins registered through the left slot.
Au. 6	Coins Thru Right Slot	Provides the total amount of coins registered through the right slot.
Au. 7	Coins Thru Center Slot	Provides the total amount of coins registered through the center slot.
Au. 8	Coins Thru 4th Slot	Provides the total amount of coins registered through the fourth slot.
Au. 9	Provides the total Coins	Provides the total amount of coins registered through all the slots.
Au. 10	Provides the total Earnings	The total cash value accumulated since the last <i>Factory Restore</i> occurred (see Chapter 5, Go to Reset Menu, of this section).
Au. 11	Meter Clicks	Provides the total number of money clicks accumulated. (Based on the country's lowest coin denomination used for the game credit.
Au. 12	Software Meter	Provides the continuing total of Meter Clicks. This audit cannot be reset; the display shows the constant addition of Meter Clicks.



SEGA AUDITS (13-46)

From the AUDITS MENU, select the "SEGA" icon with either Flipper Button and press the Start Button. Select and activate the "RIGHT ARROW" icon to view the 1st audit in this group. Continue to select either of the "ARROW" icons to view each audit one at a time. The display will describe the audit number, the audit name, and the audit total or value. The current audit will remain in the display until the next audit is chosen or when the sub-menu is exited.

Au. N ^o	Audit Name	Audit Definition
Au. 13	Total Balls Played	Provides the total of regular and extra balls.
Au. 14	Total Extra Balls	Provides the total number of extra balls awarded.
Au. 15	Extra Balls Percent	This percentage is derived from dividing Audit 14, Total Extra Balls, by Audit 26, Total Plays.
Au. 16	Replay 1 Awards	Provides the total awards (credit, extra ball, or audit) for level 1.
Au. 17	Replay 2+ Awards	Provides the total awards (credit, extra ball, or audit) for level(s) 2 or higher.
Au. 18	Total Replays	Provides the total awards (credits, extra balls, or audit only) for exceeding replay score levels.
Au. 19	Replay Percent	The replay total awards for exceeding replay score levels. This percentage is derived from dividing Audit 18, Total Replays, by Audit 26, Total Plays.
Au. 20	Total Specials	Provides the total awards (credits, extra balls, or scores) for making specials.
Au. 21	Special Percent	This percentage is derived from dividing Audit 20, Total Specials by Audit 26, Total Plays.
Au. 22	Total Matches	Provides the total credits awarded for matching the last two digits of the score with the system-generated Match Number at the end of the game. Percentage of match credits is adjustable from 0% to 10% by Ad. 11, Match Percentage, if enabled. (See Chapter 4, Go to Adjustments Menu, of this section.)
Au. 23	High Score Awards	Provides the total credits awarded for exceeding the High-Score-To-Date scores.
Au. 24	High Score Percent	This percentage is derived from dividing Audit 23, High Score Awards, by Audit 26, Total Plays.
Au. 25	Total Free Plays	Provides the total free credits for replays, High-Score-To-Date, Specials, and Match.
Au. 26	Total Plays	This total is derived by adding the sum of Audit 1, Total Paid Credits, and Audit 25, Total Free Plays. Note that free credits are not recorded in the Audit until they are actually used.
Au. 27	0.0M to 99.9M	Provides the total number of games the Player's final score was between 0 and 99,999,990 points.
Au. 28	100.0M to 199.9M	Provides the total number of games the Player's final score was between 100,000,000 and 199,999,990 points.
Au. 29	200.0M to 399.9M	Provides the total number of games the Player's final score was between 200,000,000 and 399,999,990 points.
Au. 30	400.0M to 799.9M	Provides the total number of games the Player's final score was between 400,000,000 and 799,999,990 points.
Au. 31	800.0M to 1.19B	Provides the total number of games the Player's final score was between 800,000,000 and 1,199,999,990 points.
Au. 32	1.20B+ Scores	Provides the total number of games the Player's final score was over 1,200,000,000 points.
Au. 33	Average Scores	This total is derived from adding the Final Score of each game to a table and dividing this sum by Audit 26, Total Plays.



Sega Audits Continued.

Audit Name	Audit Definition
Au. 34 Service Credits	Provides the total number of Service credits added to the game. (See Chapter 1, Introduction [Access & Use] for instructions on how to receive Service Credits.)
Au. 35, 36, 37 Proprietary	Provides information to the game designer to aid in design development (not for consumer use).
Au. 38 Total Buyin Games	Provides the number of times a player utilized the Buyin Feature. The Buyin Feature is adjustable using Ad. 34, Buyin Type. (See Chapter 4, Go to Adjustments Menu, of this section.)
Au. 39 Total Extra Ball Buyins	Provides the total number of times the Extra Ball Buyin Feature was used. The Extra Ball Buyin Feature is adjustable using Ad. 34, Buyin Type. (See Chapter 4, Go to Adjustments Menu, of this section.)
Au. 40 Extra Ball Buyin Replays	Provides the total number of replay awards that resulted from the use of Audit 39, Total Extra Ball Buyins.
Au. 41 Extra Ball Buyin HSTDS	Provides the total number of times in which use of the Extra Ball Buyin Feature resulted from beating the High-Score-To-Date (HSTD).
Au. 42 Left Drains	Provides the number of times the ball drained out the left drain.
Au. 43 Center Drains	Provides the number of times the ball drained out the center drain.
Au. 44 Right Drains	Provides the number of times the ball drained out the right drain.
Au. 45 Total Slam Tilts	Provides the number of times the Slam Tilt switch was activated.
Au. 46 Total Balls Saved	Provides the total number of times the Total Balls Saved Feature was used. This feature is enabled at the start of each ball and is disabled as soon as the ball makes contact with 5 game switches or allocated time expired.



BATMAN FOREVER AUDITS (47-XX)

From the AUDITS MENU, select the "BAT" icon with either Flipper Button and press the Start Button. Select and activate the "RIGHT ARROW" icon to view the 1st audit in this group. Continue to select either of the "ARROW" icons to view each audit one at a time. The display will describe the audit number, the audit name, and the audit total or value. The current audit will remain in the display until the next audit is chosen or when the sub-menu is exited.

Au. No	Audit Name	Audit Definition
Au. 47		
Au. 48		
Au. 49		
Au. 50		
Au. 51		
Au. 52		
Au. 53		
Au. 54		
Au. 55		
Au. 56		
Au. 57		



Batman Forever Audits Continued.

Audit Name

Audit Definition

Au. 58

Au. 59

Au. 60

Au. 61

Au. 62

Au. 63

Au. 64

Au. 65

Au. 66

Au. 67

Au. 68

Au. 69

Au. 70

Au. 71

Au. 72

Au. 73

Au. 74

Au. 75

Au. 76

Au. 77

Au. 78

Au. 79

Au. 80

Au. 81

Au. 82

Section 3 | Chapter 3



Batman Forever Audits Continued.

Audit Name	Audit Definition
Au. 83	
Au. 84	
Au. 85	
Au. 86	
Au. 87	
Au. 88	



Audit Note: 1st Way to Reset Audits

To reset audits, from the MAIN MENU, select the "ADJ" Icon. See Chapter 4, Go to Adjustments Menu, of this section.



Select the "SEGA" Icon, from the ADJUSTMENT MENU, and advance to Adj. 8, Reset Coin Audits, with the "RIGHT ARROW" Icon. Select the "+" Icon to change setting to YES. When enabled, the Coin Audits (5-11) will be reset to zero.

Advance to Adj. 9, Reset Game Audits, with the "RIGHT ARROW" Icon. Select the "+" Icon to change setting to YES. When enabled, all the audits will be reset to zero, except for the Coin Audits (5-11) and Audit 12, Software Meter (the only audit which cannot be reset to zero).



Audit Note: 2nd Way to Reset Audits

To reset audits, from the MAIN MENU, select the "RESET" Icon. See Chapter 5, Go to Reset Menu, of this section.

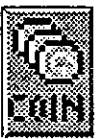

Selection of the "COIN" Icon, from the RESET MENU, will reset the Coin Audits (5-11) to zero.



Selection of the "AUD" Icon, from the RESET MENU, will reset all audits to zero, except for the Coin Audits (5-11) and Audit 12, Software Meter (the only audit which cannot be reset to zero).



BATMAN FOREVER GAME ADJUSTMENT TABLE



Some adjustments have a "Drop-Down" Table where further customization is required.



SEGA ADJUSTMENTS 1-43

N°	Adjustment Name	Factory Setting
1	REPLAYS: FIXED/MANUAL <small>"Drop-Down"</small>	10%
2	REPLAY LEVELS <small>"Drop-Down"</small>	1
3	REPLAY AWARD	CREDIT
4	FREE GAME LIMIT	5
5	EXTRA BALL LIMIT	3
6	GAME DIFFICULTY <small>"Drop-Down"</small>	MODERATE
7	GAME PRICING <small>"Drop-Down"</small>	USA7
8	RESET COIN AUDITS	NO
9	RESET GAME AUDITS	NO
10	RESTORE HIGH SCORES	NO
11	MATCH PERCENTAGE	9%
12	BALLS PER GAME	3
13	TILT WARNINGS	1
14	REPLAY BOOST	YES
15	CREDIT LIMIT	30
16	ALLOW HIGH SCORES	YES
17	AWARD FOR HIGH SCORE #1	3
18	AWARD FOR HIGH SCORE #2	1
19	AWARD FOR HIGH SCORE #3	0
20	AWARD FOR HIGH SCORE #4	0
21	DEFAULT HIGH SCORE #1	2,400,000
22	DEFAULT HIGH SCORE #2	2,100,000
23	DEFAULT HIGH SCORE #3	1,950,000
24	DEFAULT HIGH SCORE #4	1,800,000
25	DEFAULT HIGH SCORE #5	1,650,000
26	DEFAULT HIGH SCORE #6	1,500,000
27	HSTD RESET COUNT	700
28	FREE PLAY	NO
29	CUSTOM MESSAGE	ENABLE
30	ATTRACT MODE MUSIC	ON
31	FLASH LAMP POWER	NORMAL



Continued

SEGA ADJUSTMENTS 1-43

N°	Adjustment Name	Factory Setting
32	COIL PULSE POWER	NORMAL
33	MINIMUM GAME TIME	0:00
34	BUYIN TYPE	EXTRA BALL
35	EXTRA BALL BUYIN COUNT	1
36	GAME RESTART	YES
37	EXTRA BALL PERCENTAGE	25%
38	BILL VALIDATOR	NO
39	TOURNAMENT MODE	OFF
40	EXTERNAL REPLAY KNOCKER	OFF
41	SPECIAL MEMORY	YES
42	LOCATION ID	0
43	GAME ID	0



BATMAN FOREVER ADJUSTMENTS 44-58?

N°	Adjustment Name	Factory Setting
44	LASER KICK CRITERION	MODERATE
45	MBALL RESTART CRITERION	MODERATE
46	EXTRA BALL MEMORY	YES
47	LOCK QUALIFY CRITERION	MODERATE
48	LOCK QUALIFY TIMER	45
49	MODE START CRITERION	EASY
50		
51		
52		
53		
54		
55		
56		
57		
58		

Go To Adjustments Menu

Overview

The Portals™ Service Menu System provides XX Adjustment Functions to vary game difficulty or customize (i.e. adjusting High Score Levels, the number of balls per game, Extra Ball Buyin, Game Pricing, Default High Scores, etc.). The Adjustment Functions are split into 2 groups. The first group, Sega Adjustments, are the game play generic adjustments (1-44). The second group, Batman Forever Adjustments, are the game play specific adjustments (44-58?). Each group may be viewed manually after entering the Portals™ Service Menu (see Chapter 1, Introduction, of this section). All adjustments can be viewed at a glance with the Game Adjustment Table provided on the previous page. If a value is changed, the display will indicate REQUEST INSTALLED.

GO TO ADJUSTMENTS MENU



With the game in the Attract Mode, open the Coin Door and press the Black "BEGIN TEST" Button. Select the "ADJ" Icon in the MAIN MENU with either Flipper Button and press the Start Button. The ADJUSTMENTS MENU appears.

Important Notes:



Exit any sub-menu and return to the MAIN MENU by selecting & activating the "PREV" Icons. If no Icons appear in the display because of a testing function or special display (e.g. "Help"), press any button to exit.



Selecting & activating the "QUIT" Icon from any display will exit the Service Session.



Selecting & activating the "HELP" Icon from any display will show a help screen. (See chapter 7 of this section for more help.)



In Adjustments, selecting & activating the "-" Icon decrements the value setting. Selecting & activating the "+" Icon increments the value setting.



Selecting & activating the "ARROW" Icons selects the next or previous adj. in the group.

SEGA ADJUSTMENTS (1-44)



From the ADJUSTMENTS MENU, select the "SEGA" Icon with either Flipper Button and press the Start Button. Select and activate the "RIGHT ARROW" Icon to view the 1st adjustment in this group. Continue to select either of the "ARROW" Icons to view each adjustment one at a time. Select either the "-" or "+" Icons to change the value, if desired. The display will describe the adjustment number, the adjustment name, and the adjustment total or value. The current adjustment will remain in the display until the next adjustment is chosen or when the sub-menu is exited.

Adj. N°	Adjustment Name	Adjustment Definition
Adj. 1	Replays: Fixed / Manual	Adjust for percentage of awards for Replay Levels (1% through 50%). Lower the automatic value to 0% and the display will indicated Fixed. Replays may be adjusted either for fixed levels or for a system-adjusted manual percentage of replay awards. Four levels may be selected. Adjustments allow awarding of a credit or an extra ball as each level is exceeded. With the manual percentage feature, if the actual replay percentage is higher or lower than that desired, the game computes new recommended manual percentage score(s). When the coin door is subsequently opened the player displays indicate the recommended level and a sound is made to alert the operator of a potential change. This new level is entered into adjustments simply by pressing the game start push-button. (If the coin door is closed or you enter audits/adjustments or diagnostics, the replay level is not changed.)
Adj. 2	Replay Levels	Adjust the number of replay levels to be active (1 to 4). Once the number of Replay Levels has been selected, a "Drop-Down" Table appears showing Replay Level 1. Adjust Replay Level 1 between 100M - 9.99B. Adjust Replay Level 2, 3 and/or 4 respectively.



Sega Adjustments Continued.

Adjustment Name	Adjustment Definition
Adj. 3 Replay Award	Set for replays to award: CREDIT, EXTRA BALL, NONE or SPECIAL (When score threshold is achieved, a Playfield Special is lit.)
Adj. 4 Free Game Limit	Adjust the max. # of free games that may be accumulated per game; 0 - 9.
Adj. 5 Extra Ball Limit	Adjust the max. # of extra balls that may be accumulated per game; 1- 9 or OFF.
Adj. 6 Game Difficulty	Any one of the INSTALL settings (in a "Drop-Down" Table) for this adjustment may be activated to automatically select settings for multiple adjustments affecting game difficulty. Select and activate the "-" or "+" icons to choose the difficulty level required. After activation, the individual adjustments may be readjusted, if desired. Refer to the Install Adjustment Table below for details. Set to EXTRA EASY, EASY, MODERATE, HARD or EXTRA HARD. (Note: Additional game features which are not adjusted may also change when adjusting this adjustment.)

Install Adjustments	Adj. 6 Extra Easy	Adj. 6 Easy	Adj. 6 Moderate	Adj. 6 Hard	Adj. 6 Extra Hard
(44) Laser Kick Criterion	MODERATE	MODERATE	MODERATE	HARD	EXTRA HARD
(45) Mball Restart Criterion	EXTRA EASY	EASY	EASY	HARD	EXTRA HARD
(46) Extra Ball Memory	YES	YES	YES	YES	NO
(47) Lock Qualify Criterion	EXTRA EASY	EASY	EASY	HARD	EXTRA HARD
(48) Lock Qualify Timer	45	40	35	30	25
(49) Mode Start Criterion	EXTRA EASY	EASY	EASY	HARD	EXTRA HARD

Play Rules: Novelty & 5-Ball, plus Add-A-Ball Settings

The following three combinations are recommended for situations where local laws restrict certain game features regarding the use of replays or the number of balls per game:

Novelty Play Rules - Set to establish recommended settings for no free play or extra balls:

Adj.	Adjustment Name	Setting	Adj.	Adjustment Name	Setting
1	Replays: Fixed/Manual	Fixed	5	Extra Ball Limit	00
2	Replay Levels	None	11	Match Percentage	Off
3	Replay Award	None	17	Award for High Score #1	3
4	Free Game Limit	00	18	Award for High Score #2	1

5-Ball Play Rules - Set to establish recommended settings for 5-ball play:

Adj.	Adjustment Name	Setting	Adj.	Adjustment Name	Setting
1	Replays: Fixed/Manual	07%	5	Extra Ball Limit	3
2	Replay Levels	1	11	Match Percentage	4
3	Replay Award	Credit	12	Balls Per Game	5
4	Free Game Limit	5	17	Award for High Score #1	3
			18	Award for High Score #2	1

Add-A-Ball Settings-To disable awarding of credits and provide awards with an extra ball:

Adj.	Adjustment Name	Setting	Adj.	Adjustment Name	Setting
3	Replay Award	Extra Ball	16	Allow High Scores	No
4	Free Game Limit	00	17-20	Award for High Score #1 - #4	00
11	Match Percentage	Off			



Sega Adjustments Continued.

Adjustment Name	Adjustment Definition
-----------------	-----------------------

Adj. 7 Game Pricing

There are two methods available for coin switch programming: Standard & Custom. Standard pricing uses a single adjustment as seen in the first display. See the Standard Pricing Table. If "Custom" is selected, a "Drop-Down" Table appears. Select a pricing scheme shown in the Custom Pricing Table as seen below.

With Adjustment 7 set to CUSTOM operating the step button again initiates a drop down menu representing coin switch pulses for the left, right, center and fourth coin slots. The prescribed number of pulses are required for one credit. For example, if *Left Coin Pulses*, was set to 02 and *Coin Switch Pulses Required for 1 Credit*, to 01 a coin in the left slot would produce two credits. Further, if *Left Coin Pulses*, was set to 01 and *Coin Switch Pulses Required for 1 Credit*, to 02, two coins in the left slot would be required for one credit.

Coin Switch Pulses Required for Bonus Credit may be set to post bonus credits when a minimum amount of coins are inserted at one time. For example, if *Left Coin Pulses* was set to 01, *Coin Switch Pulses Required for 1 Credit* to 01 and *Coin Switch Pulses Required for Bonus Credit* to 04, one credit would be posted for each of the first three coins in the left slot and two credits for the fourth coin.

Standard/Custom Pricing - Set for the desired pricing scheme from the Standard Pricing Table as indicated on the dot matrix display. For Custom Pricing, set to CUSTOM. When set to CUSTOM, the following adjustments are utilized to tailor each individual coin chute.

Left Coin Switch Pulses - Set the number of pulses registered for closure of the left coin switch; 00 to 99.

Right Coin Switch Pulses - Set the number of pulses registered for closure of the right coin switch; 00 to 99.

Center Coin Switch Pulses - Set the number of pulses registered for closure of the center coin switch; 00 to 99.

4th Coin Switch Pulses - Set the number of pulses registered for closure of the fourth coin switch; 00 to 99.

Coin Switch Pulses Required for 1 Credit - Set the number of coin switch pulses required to post one credit; 00 to 99.

Coin Switch Pulses Required for Bonus Credit - Set the number of coin switch pulses required to award the 1st bonus credit(s); 00 to 99.

Coin Switch Pulses Required for 2nd Bonus Credit - Set the number of coin switch pulses required to award the 2nd bonus credit; 00 to 99.

Credits awarded for 1st Bonus - Set the number of credits awarded for achieving the first Bonus level; 00 to 99.

Custom Pricing Table

Coin Mechs				Adjustments									
Left	Right	Center	4th	Plays/Coins	Left Pulses	Right Pulses	Mid Pulses	4th Pulses	Pulses /Credit	Pulses /Bonus	Pulses /2nd Bonus	Credit /1st Bonus	
25¢	25¢	\$1.00	N/U		1/25¢ 3/50¢	01	01	04	00	01	02	00	01
				1/25¢ 5/\$1.00	01	01	04	00	01	04	00	01	
				1/25¢ 6/\$1.00	05	05	20	00	04	20	00	01	
5SCH	10SCH	10SCH	N/U	1/10 S	01	02	02	00	02	00	00	00	
				1/10 S 4/30 S	04	08	08	00	06	00	00	00	
10p	£1	50p	20p	1/30p 2/50p 5/£1	01	15	06	02	03	00	00	00	
				1/50p 3/£1	01	15	05	02	05	00	00	00	
				1/30p 4/£1	01	12	05	02	03	00	00	00	
20¢	\$1.00	N/U	N/U	1/60¢ 2/\$1.00	01	05	00	00	03	05	00	01	

Standard Pricing Table

on the next page.

Standard Pricing Table

Adj. 7 Standard Pricing Select	Coin Mechanisms				Pricing Scheme Explained <i>Number of "Plays" for Price Amount Shown</i>			
	Left	Center	Right	Right				
	1st Slot	2nd Slot	3rd Slot	4th Slot				
USA 1	25¢	\$1	25¢		1/25¢			
USA 2	25¢	\$1	25¢		1/50¢	2/75¢	3/\$1	
USA 3	25¢	\$1	25¢		1/50¢			
USA 4	25¢		25¢		1/50¢			
USA 5	25¢	\$1	25¢		1/50¢	5/\$2		
USA 6	25¢	\$1	25¢		1/50¢	2/4X25¢	3/\$1 (bill)	Used to promote the Bill Validator
USA 7 ★	25¢	\$1	25¢		1/50¢	4/\$1.50	6/\$2	
Austria	5S	10S	10S		1/10S	2/15S	3/20S	
Australia	20¢	\$A 1	\$A 2		1/\$A 1	3/\$A 2		
Australia 2	20¢	\$1	\$2		1/\$1	2/\$2		
Belgium	5 BF	20 BF	50 BF		1/20 BF	3/50 BF		
Canada	25¢	25¢	Can\$ 1		1/50¢	2/75¢	3/Can\$ 1	
Denmark 1	1DKr	5 DKr	10 DKr	20 DKr	1/3 DKr	2/5 DKr		
Denmark 2	1DKr	5 DKr	10 DKr	20 DKr	1/2 DKr	3/5 DKr	7/10 DKr	
Finland	1Fmk	5Fmk			1/5Fmk	4/10Fmk		
France 1 ★	1 Fr	5 Fr	10 Fr	20 Fr	1/3 Fr	2/5 Fr	5/10 Fr	11/20 Fr
France 2	1 Fr	5 Fr	10 Fr	20 Fr	1/5 Fr	3/10 Fr	7/20 Fr	
France 3	1 Fr	5 Fr	10 Fr	20 Fr	1/3 Fr	2/5 Fr	4/10 Fr	9/20 Fr
Germany 1	1DM	2DM	5DM		1/1 DM	5/5DM		
Germany 2	1DM	2DM	5DM		1/1DM	6/5DM		
Germany 3 ★	1DM	2DM	5DM		1/2DM	2/3DM	3/4DM6	6/6DM
Greece	50Dr		100Dr		1/50Dr	3/100Dr		
Holland (See Netherlands 2)								
Hungary	10 Ft	10 Ft	20 Ft		1/20 Ft	3/40 Ft		
Italy 1	500 Lit		500 Lit		1/500 Lit			
Italy 2	500 Lit		500 Lit		1/1000 Lit	3/2000 Lit		
Japan			100¥		1/100¥	3/200¥		
Korea	100Won		100Won		1/100Won			
Netherlands 1	1 Fls.	1 Fls.	2.5 Fls.		1/1Fls.	3/2.5 Fls.		
Netherlands 2 ★	1 Fls.	2.5 Fls.	5 Fls.		1/1Fls.	3/2.5 Fls.	6/5 Fls.	
New Zealand 1	\$NZ 1		\$NZ 2		1/\$NZ 1	2/\$NZ 2		
New Zealand 2	\$NZ 1		\$NZ 2		1/\$NZ 1	3/\$NZ 2		
Norway 1	10 NKr	5 NKr	20 NKr		2/10 NKr	1/5 NKr	4/20 NKr	
Norway 2	10 NKr	5 NKr	20 NKr		1/10 NKr	3/20 NKr		
Spain	100Pts		500Pts		1/100Pts	6/500Pts		
Sweden	1 SKr	5 SKr	10 SKr		1/10 SKr	2/15 SKr	3/20 SKr	
Switzerland 1 ★	1 SwF	2 SwF	5 SwF		1/1 SwF	6/5 SwF		
Switzerland 2	1 SwF	2 SwF	5 SwF		1/1 SwF	3/2 SwF	9/5 SwF	
UK 1	10p	50p	1£	20p	1/50p	3/1£		
UK 2	10p	50p	1£	20p	1/40p	3/1£		
UK 3 ★	10p	50p	1£	20p	1/50p			
Yugoslavia	5 Din		5 Din		1/5 Din			

★ Default Factory Setting.



Sega Adjustments Continued.

Adjustment Name	Adjustment Definition
Adj. 8 Reset Coin Audits	Default is NO. Select the "+" Icon to change to YES. When enabled, all <i>Coin Audits</i> (Audits 5-11), will be reset to zero.
Adj. 9 Reset Game Audits	Default is NO. Select the "+" Icon to change to YES. When enabled, all audits will be reset to zero, except for the <i>Coin Audits</i> (Audits 5-11) and Audit 12, Software Meter (the only audit which cannot be reset to zero).
Adj. 10 Restore High Scores	When enabled (set to YES) the High Score Levels and associated initials will be restored to the backup settings when the "+" Icon is selected and activated.
Adj. 11 Match Percentage	Set Match percent from 00% to 10% or OFF. At 00% the match display occurs at the end of the game but never awards a credit.
Adj. 12 Balls Per Game	Adjust the number of balls per game; 2 to 5. Default is 3.
Adj. 13 Tilt Warnings	Adjust the number of plumb bob tilt switch closures before the ball in play is tilted; 1, 2, 3 or OFF.
Adj. 14 Replay Boost	Set to YES or NO. When set to YES, exceeding a replay will set a temporary replay level for each time a replay level is surpassed. This new level will equal the previous replay level (when the replay was awarded) plus 50 Million for each following game, until the replays have all been played. At this time the previous level is resumed.
Adj. 15 Credit Limit	Adjust the maximum number of credits that may be posted; 4 to 50. Default is 30.
<p>Note: There are 4 of the 6 High Score Levels with associated player initials that are displayed during the attract mode. This provides a High-Score-To-Date feature. When players exceed these levels, the player initials may be entered to replace the previous ones. These levels may be adjusted to award credits and to be reset to backup values after a selected number of games.</p>	
Adj. 16 Allow High Scores	Set to enable (set to YES) or disable the four high score levels by setting to zero.
Adj. 17 Award for High Score #1	Adjust the number of awards (0 to 4) awarded for exceeding level 1 (the highest of the four levels).
Adj. 18 Award for High Score #2	Adjust the number of awards (0 to 3) awarded for exceeding level 2.
Adj. 19 Award for High Score #3	Adjust the number of awards (0 to 2) awarded for exceeding level 3.
Adj. 20 Award for High Score #4	Adjust the number of awards (0 to 1) awarded for exceeding level 4.
Adj. 21-26 Default High Score #1 - #6	Adjust the score level to which the world record, (level 1) (the highest of the four levels) may be altered. This adjustment is not affected by Adj. 28, <i>Reset High Score To Date</i> . Adjust the backup score to which levels 2 - 6 may be reset, respectively.
Adj. 27 HSTD Reset Count	HSTD (High Score To Date). Adjust the number of games between automatic resets of high score levels to backup settings and ball time averager adjustments; 100 to 900 or OFF (no reset or adjustment).
Adj. 28 Free Play	When set to YES, no coins are required for games.
Adj. 29 Custom Message	When desired, this function is used to establish a custom message periodically displayed during the attract mode. Set the feature to CHANGE using the Credit button and depress STEP. The letter A is indicated in the first position in the display. Vary the letter by operating the left and right flippers. With the desired letter indicated, depress the START Button to lock in the letter and advance to the next character. Repeat this procedure until the desired message is completed in the display. Press the STEP push-button switch to advance to the next adjustment.
Adj. 30 Attract Mode Music	Set to ON or OFF. When set to ON, attraction music is played between games. -



Sega Adjustments Continued.

Adjustment Name	Adjustment Definition
Adj. 31 Flash Lamp Power	Set to NORMAL, DIM or OFF. When set to NORMAL the flash lamps are active, when DIM the flash lamps impulse power is reduced by 25% and when OFF the flash lamps will not flash.
Adj. 32 Coil Pulse Power	Set to NORMAL, HARD or SOFT. When HARD the coil pulse power is <i>increased</i> by 12.5% of the normal pulse rate. When set to SOFT the coil pulse power is <i>decreased</i> by 12.5% of the normal pulse rate. These adjustments are provided to compensate for Low Line or High Line voltage conditions where the solenoids appear to kicking too weak or too hard. Adjust as required.
Adj. 33 Minimum Game Time	Default is 0:00. Set between 0:00 - 8:59 for minimum game time. If the last ball in play drains prior to what the game time is set for, another ball will be served into the shooter lane and normal play will continue. Subsequent balls will continue to do be served into the shooter lane if the last ball still drains prior to and up until minimum game time is satisfied.
Adj. 34 Buyin Type	Set to Extra Ball Buyin. When set to EXTRA BALL, the game is set to Extra Ball Buyin. When set to FEATURE, the game is set to Game (Feature) Buyin. Set to OFF to make Buyin Type inoperative.
Adj. 35 Extra Ball Buyin Count	1, 0 or UNLIMITED. Default is 1. Allows the operator to adjust the number of Extra Ball Buyins allowed after normal game play. Review Section 2, Chapter 1, Game Operations & Features for details.
Adj. 36 Game Restart	Set to YES or NO. When set to YES, a new game may be started during any ball after the first ball is completed (if credits are available). (Note-Pressing start during the first ball will add additional players.) When set to NO, the game disables the start button after the first ball until the final ball is in play. Review Section 2, Chapter 1, Game Operations & Features for details.
Adj. 37 Extra Ball Percentage	Set from 0 to 50. Allows the operator to adjust how frequently the Extra Ball feature is made available to the player.
Adj. 38 Bill Validator	Set to YES or NO. When set to YES, the display, in game attract mode, will show an "Insert Bill Animation". When set to NO, the display, in game attract mode will show "Insert Coin Animation".
Adj. 39 Tournament Mode	Set to NONE, PINBALL EXPO, IFPA-PAPA or HOME. Tournament Mode determines the default conditions to quickly prepare a game for tournament play. When this setting is changed all audits will be reset and all adjustments will be initiated to the particular style selected. The game will then return to game over attract mode, as if a Factory Reset had been performed. NONE - Same as a Factory Reset conditions. IFPA-Straight 50¢ play, no replay, no Extra Ball, no High Scores, 2 Tilt Warnings and No Match. PINBALL EXPO-PAPA-Same as IFPA settings except Free Play is enabled. HOME-Sets game for Free Play, extra ball play, no replay, 10% Match & Extra Ball percent 30%.
Adj. 40 External Replay Knocker	Set to ON or OFF. When set to ON, the operator can enable the knocker in the cabinet to drive an external device without the game giving a replay.
Adj. 41 Special Memory	Set to YES or NO. When set to YES, the lit 'Special' light will be retained in memory from ball to ball for the same player. When set to NO, the lit 'Special' light will go out at the end of each ball.
Adj. 42 Location ID	0 to 9999. Allows the operator to assign a location identification number to the audit print-out sheet. (Will not be affected by Factory Reset.) See Chp. 5, Go to Reset Menu & Chp. 6, Go to Printer Menu, of this section for more details on Factory Reset & Printing Options.
Adj. 43 Game ID	0 to 9999. Allows the operator to assign a game identification number to the audit print-out sheet. (Will not be affected by Factory Reset.) See Chp. 5; Go to Reset Menu & Chp. 6, Go to Printer Menu, of this section for more details on Factory Reset & Printing Options.



BATMAN FOREVER ADJUSTMENTS (44-XX)

From the ADJUSTMENTS MENU, select the "BAT" *Icon* with either Flipper Button and press the Start Button. Select and activate the "RIGHT ARROW" *Icon* to view the 1st adjustment in this group. Continue to select either of the "ARROW" *Icons* to view each adjustment one at a time. Select either the "-" or "+" *Icons* to change the value, if desired. The display will describe the adjustment number, the adjustment name, and the adjustment total or value. The current adjustment will remain in the display until the next adjustment is chosen or when the sub-menu is exited.

Adj. N°	Adjustment Name	Adjustment Definition
Adj. 44		
Adj. 45		
Adj. 46		
Adj. 47		
Adj. 48		
Adj. 49		
Adj. 50		
Adj. 51		
Adj. 52		
Adj. 53		
Adj. 54		
Adj. 55		
Adj. 56		
Adj. 57		
Adj. 58		

Go To Reset Menu

Overview

The Portals™ Service Menu System provides three (3) functions to reset adjustments and/or audits back to the *Factory Setting*. See Chapter 3, Go to Audits Menu, and Chapter 5, Go to Adjustments Menu, for the Game Audits & Adjustments Information. If a *Factory Reset* is performed, the Service Session is exited and returns to the Attract Mode. If reset of Coin or Game Audits is performed, the display will indicate **REQUEST INSTALLED** and return to the **RESET MENU**. Please note that once reset, all customized settings are lost! Certain audits and adjustments however cannot be reset (refer to the details below).



GO TO RESET MENU

With the game in the Attract Mode, open the Coin Door and press the Black "BEGIN TEST" Button. Select the "RESET" Icon in the MAIN MENU with either Flipper Button and press the Start Button. The **RESET MENU** appears.

Important Notes:



Exit any sub-menu and return to the MAIN MENU by selecting & activating the "PREV" Icon.



Selecting & activating the "QUIT" Icon from the display will exit the Service Session.



Selecting & activating the "HELP" Icon from the display will show a help screen. (See chapter 7 of this section for more help.)

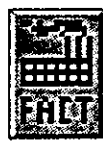

FACTORY RESET

From the **RESET MENU**, select the "FACT" Icon with either Flipper Button and press the Start Button. The display will indicate **REQUEST INSTALLED** and exit the Service Session. All adjustments will be reset to *Factory Settings* (except for Proprietary Adjustments). See Chapter 4, Go to Adjustments Menu, of this section, for the *Factory Settings* in the Game Adjustment Table.



RESET COIN AUDITS

From the **RESET MENU**, select the "COIN" Icon with either Flipper Button and press the Start Button. The display will indicate **REQUEST INSTALLED** and return to the **RESET MENU**. Coin Audits can also be reset from the **ADJUSTMENTS MENU**, SEGA ADJUSTMENT 8. See Chapter 4, Go to Adjustments Menu, of this section. After selecting this Icon, all of the *Coin Audits (5-11)* are reset to zero.

See Fig. 1.



RESET GAME AUDITS

From the **RESET MENU**, select the "AUD" Icon with either Flipper Button and press the Start Button. The display will indicate **REQUEST INSTALLED** and return to the **RESET MENU**. Coin Audits can also be reset from the **ADJUSTMENTS MENU**, SEGA ADJUSTMENT 9. See Chapter 4, Go to Adjustments Menu, of this section. After selecting this Icon, all of the *Audits* are reset to zero, except for the Coin Audits (Audits 5-11) and Audit 12, Software Meter. Audit 12 is the only audit which cannot be reset.

See Fig. 2.

Fig. 1

• Reset Coin Audits	
Earnings Audits (Coin Audits Only 5-11)	
Au. N°	Description
1-4	The first 4 Audits in the game.
5	Coins Thru Left Slot
6	Coins Thru Right Slot
7	Coins Thru Center Slot
8	Coins Thru 4th Slot
9	Total Coins
10	Total Earnings
11	Meter Clicks
12	Software Meter
13 +	The remainder of the Audits.

Fig. 2

• Reset Game Audits	
Earnings (1-4), Generic/Specific Audits (13+)	
Au. N°	Description
1-4	The first 4 Audits in the game.
5	Coins Thru Left Slot
6	Coins Thru Right Slot
7	Coins Thru Center Slot
8	Coins Thru 4th Slot
9	Total Coins
10	Total Earnings
11	Meter Clicks
12	Software Meter
13 +	The remainder of the Audits.

Example:

From the MAIN MENU, use the Left or Right Flipper Button to select the "RESET" Icon (GO TO RESET MENU).

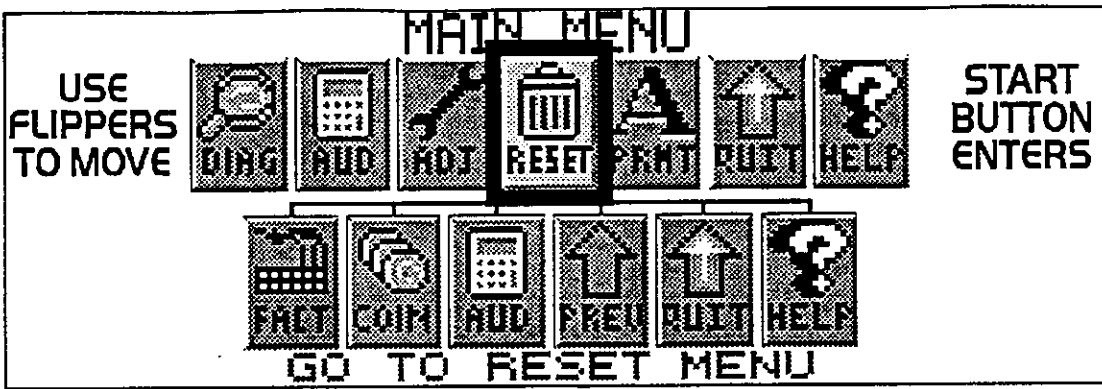

Press the Start Button to activate this ICON. This will bring up the RESET MENU.

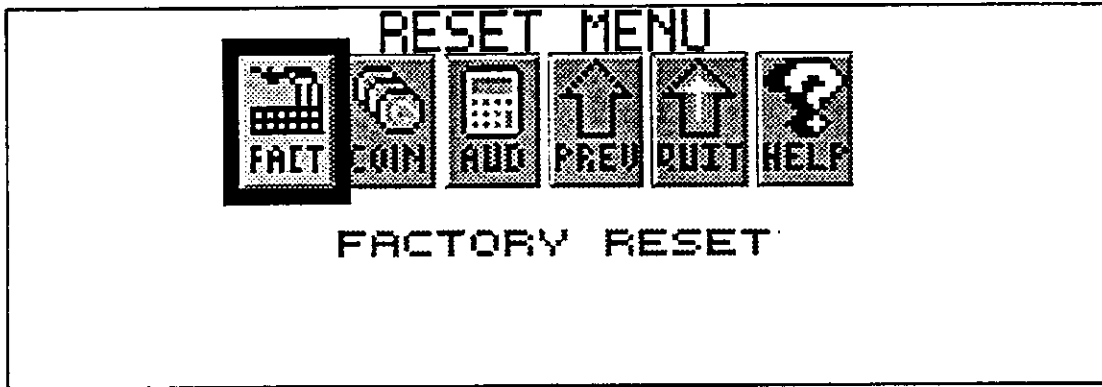

The RESET MENU now appears with the "FACT" Icon (FACTORY RESTORE) flashing:

CAUTION: IF CUSTOMIZED SETTINGS ARE MADE TO THE GAME, DO NOT PRESS THE START BUTTON OR THESE SETTINGS WILL BE LOST!

Press the Start Button to activate this icon. This will reset all adjustments back to *Factory Settings*.



The REQUEST INSTALLED now appears momentarily and the *Service Session* is automatically exited with the display returning to the ATTRACT MODE.

If the "COIN" or "AUD" Icons are chosen and activated, the affected audits (see previous page) will be reset, the display will indicate REQUEST INSTALLED and return to the RESET MENU.

Go To Printer Menu

Overview

SPECIAL EQUIPMENT IS REQUIRED FOR THIS MENU

The Portals™ Service Menu System provides 3 Adjustment Functions to either print or download game information to a Laptop PC or clear the printout count. A printer interface board, hand-held printer and/or a special software program is required to run this menu. Entering this menu and selection/activation of the *Icons* without this equipment/software will not affect the game.

GO TO PRINTER MENU



With the game in the Attract Mode, open the Coin Door and press the Black "BEGIN TEST" Button. Select the "PRNT" *Icon* in the MAIN MENU with either Flipper Button and press the Start Button. The PRINTER MENU appears.

Important Notes:



Exit any sub-menu and return to the MAIN MENU by selecting & activating the "PREV" *Icons*. If no *Icons* appear in the display because of a testing function or special display (e.g. "Help"), press any button to exit.



Selecting & activating the "QUIT" *Icon* from any display will exit the Service Session.



Selecting & activating the "HELP" *Icon* from any display will show a help screen. (See chapter 7 of this section for more help.)



In printer adjustments, selecting & activating the "-" or "+" *Icons* is necessary to start a printout or download.



Selecting & activating the "ARROW" *Icons* selects the next /previous *Icon* in the sub-menu.



QUICK PRINTOUT ADJUSTMENT (59?)

From the PRINTER MENU, select the "QUICK" *Icon* with either Flipper Button and press the Start Button. Select the "+" *Icon* and press the Start Button to start the printout. Only the Earnings Audits can be printed out to a "Hand-Held" Printer.



FULL PRINTOUT ADJUSTMENT (60?)

From the PRINTER MENU, select the "ALISON" *Icon* with either Flipper Button and press the Start Button. Select the "+" *Icon* and press the Start Button to start the download. A special software program and a Lap Top PC is required. All game audits (Earnings, Sega & Game Specific) can be retrieved.



N° OF COPIES PRINTED ADJUSTMENT (61?)

From the PRINTER MENU, select the "RESET" *Icon* with either Flipper Button and press the Start Button. Select the "+" *Icon* and press the Start Button to start the clear the "N° of copies printed" count total.



PORTALS™ SERVICE MENU
PROBLEM/SOLUTION TABLE



Use this table for a quick simple solution(s) guide. For more technical assistance view Section 6.

Section 3 | Help

PROBLEM	SOLUTION
Will not enter the Service Mode after depressing the Black "BEGIN TEST" Button.	<ul style="list-style-type: none"> • Check the Service Switch(es) for loose connections or bad Ground. • Check the associated wiring harness to/from the CPU Board Connector CN14. • Check CPU Board, possibly failed.
Service Buttons (Green and Black) are nonfunctional.	<ul style="list-style-type: none"> • Check the Service Switches for poor connections or broken wires.
The display blanks out.	<ul style="list-style-type: none"> • Check the Dot Matrix Display for loose wiring harness connections. • Check Bridge Rectifier 3 & 8 Amp Slo Blo Fuse. Refer to the Game Manual.
<i>Icons "scroll"</i> along continuously in the MAIN MENU.	<ul style="list-style-type: none"> • If the Service Switch Set and/or the Coin Door was replaced, ensure the Locking Mechanism on the Green Button is removed. If the Green Button "clicks" and locks into an up/down position, the Green Button has this lock switch. Remove it. (Ref. to Service Bulletin #74.)
The Start and Flipper Buttons do not select or activate <i>Icons</i> in the SWITCH TEST MENU.	<ul style="list-style-type: none"> • This is normal. These switches are deactivated, as they are a part of the Switch Test. Use the Green "SELECT" and Black "ENTER" Buttons in this Sub-Menu (See Chapter 1).
Some <i>Icons</i> appear non-functional in the PRINTER MENU(S).	<ul style="list-style-type: none"> • If no printing equipment is connected, the "-" <i>Icon</i>, "+" <i>Icon</i> and "RUN" <i>Icon</i> will appear not to function (See Chapter 5).
Some <i>Icons</i> appear non-functional in the GAME SPECIFIC MENU under the DIAGNOSTICS MENU.	<ul style="list-style-type: none"> • If there is no other test under this Menu, the "Left Arrow" & "Right Arrow" <i>Icons</i> will appear not to function. The remaining <i>Icons</i> should function as normal. Note: If there is no Game Specific Special Test, the "GAME SPECIFIC" <i>Icon</i> will not invoke another display.
The display returns to the ATTRACT MODE exiting the Service Session from the FACTORY RESET MENU.	<ul style="list-style-type: none"> • This is normal. After a FACTORY RESET, the Service Session is automatically exited (See Chapter 4).
In COIL TEST MENU (1R-8R only) or CYCLING FLASHERS MENU, the coils will fire instead of the flashlamps.	<ul style="list-style-type: none"> • The Left /Right Relay is not operating correctly. • Check fuse F7 on the PPB. • Check Q29 on the CPU.
In COIL TEST MENU, the coils and flashlamps <i>do not</i> fire after activating the "RUN" <i>Icon</i> .	<ul style="list-style-type: none"> • Ensure the POWER INTERLOCK SWITCH (See figure on front inside cover) <i>is pulled out</i>.
Can't move selection of <i>Icon</i> with the Left and/or Right Flipper Buttons.	<ul style="list-style-type: none"> • Check the Flipper Buttons for loose connections or bad Ground and refer to the Game Manual Flipper Troubleshooting Flowchart.
Selection using the Green "SELECT" Button only moves forward or to the right.	<ul style="list-style-type: none"> • This is normal. When using the Green "SELECT" Button, the selection is only forward.

Go To Help Screen

Overview

The Portals™ Service Menu System provides help screens in each display (except if the display is in a testing mode). Each screen is basic and some terms may vary. At the beginning of each chapter in this section, *Icons* are shown and described to give detail of the particular function of the individual *Icons*. The table on the previous page was designed to help answer some questions of situations which may arise.



GO TO HELP SCREEN

With the game in the Attract Mode, open the Coin Door and press the Black "BEGIN TEST" Button. Select the "HELP" *Icon* in the MAIN MENU with either Flipper Button and press the Start Button. The HELP SCREEN appears.

MENU HELP SCREEN

USE THE FLIPPER BUTTONS TO CHANGE THE SELECTED ICON. PRESS THE START BUTTON TO ACTIVATE THE SELECTED ICON.

USE THE GREEN "SELECT" TO CHANGE THE SELECTED ICON.
USE THE BLACK "ENTER" BUTTON TO ACTIVATE THE SELECTED ICON.

Important Notes:



Exit any sub-menu and return to the MAIN MENU by selecting & activating the "PREV" *Icons*. If no *Icons* appear in the display because of a testing function or special display (e.g. "Help"), press any button to exit.



Selecting & activating the "QUIT" *Icon* from any display will exit the Service Session.



Selecting & activating the "HELP" *Icon* from any display will show a help screen. (See chapter 7 of this section for more help.)

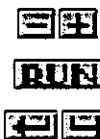

These "Mini-Icons" vary in functionality depending in what sub-menu they are used. Refer to the beginning of each chapter in this section for the function they serve in that menu.

Review Chapter 1, Introduction, on how to enter the Portals™ Service Menu. The chapter describes all the *Icon* names and the entire menu is shown in a "Tree." View the display, after selecting and activating either of the "HELP" or "?" *Icons*.

Review Chapter 2, Go to Diagnostics Menu, to find all the tests needed to troubleshooting the game.

Review Chapter 3, Go to Audits Menu, and Chapter 4, Go to Adjustments Menu, to gather play information and to customize the game to vary difficulty of play or to change functions of the game.

Review Chapter 5, Go to Reset Menu, to reset audits and adjustments to Factory Settings.

Review Chapter 6, Go to Printer Menu, to start downloading or printing functions. Special equipment is required for this function.

This concludes the Portals™ Service Menu. Review the Table of Contents at the beginning of this manual, and the detailed Table of Contents for Section 3 to quickly find the information required. The remainder of the sections in this manual will cover all the parts in this game and provide helpful information to aide in troubleshooting. If questions still arise after reading this section completely, call our Technical Support Department.