

Acorn A5000 Welcome Guide



Acorn A5000

Welcome Guide



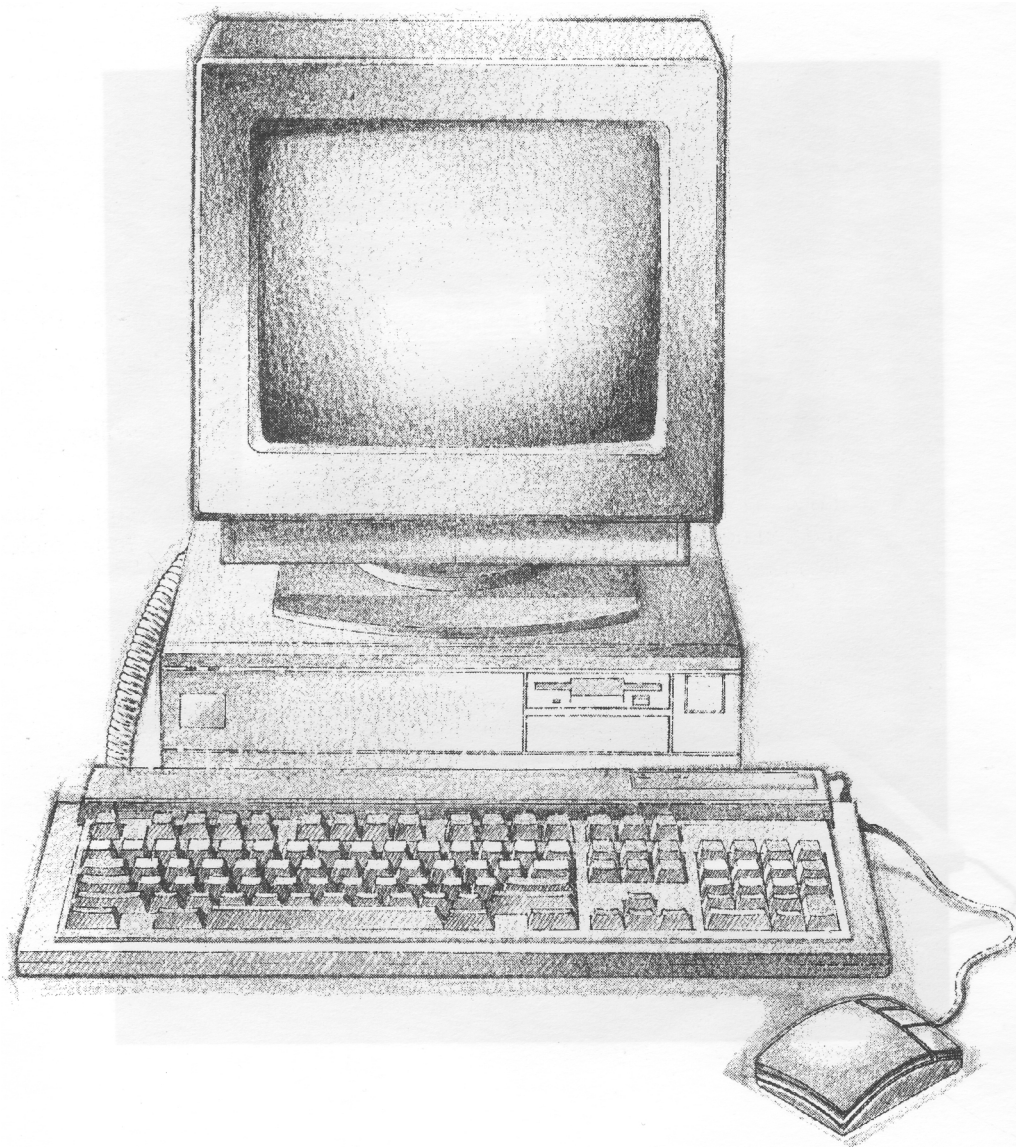

Welcome to the Acorn A5000 computer!

I am confident that this powerful and innovative machine will provide you with useful and productive service throughout its working life.

You are joining a family now several million strong, who recognise the benefits offered by our Acorn products. Should you ever feel dissatisfied with any aspect of our product or service, please contact your supplier, who has full support from Acorn itself. Please also pass on any suggestions as to how we might improve our service to you — it is with the help of such feedback that we have been able to develop your new Acorn computer.

To help us provide you with the best service, please complete and return the enclosed Owner Registration Form. This enables us to keep our valued and growing family of users informed about new developments. You are not of course obliged to answer all the questions, should you prefer to leave any of them blank.

The first part of this guide introduces the computer to you; it explains how to connect it together and how to start using it.

It doesn't matter if you've never used a computer before, the system is easy to use, and you need learn only a few simple techniques to get going. You can pick up the details as you go along.

The *Hardware reference section* gives you some advice about looking after your computer, along with more detailed information, which you may need to refer to when you want to add things like printers.

Once you have set everything up and mastered the basic techniques described in this guide, the RISC OS 3 *User Guide* and the RISC OS 3 *Applications Guide* also supplied will help you to get the best out of your computer and answer many other questions you may have about how the computer works.

A handwritten signature in black ink that reads "Sam Wauchop". The signature is written in a cursive, slightly slanted style.

Managing Director
Acorn Computers Limited

Copyright © 1991, 1992 Acorn Computers Limited. All rights reserved.
Published by Acorn Computers Technical Publications Department.

No part of this publication may be reproduced or transmitted, in any form or by any means, electronic, mechanical, photocopying, recording or otherwise, or stored in any retrieval system of any nature, without the written permission of the copyright holder and the publisher, application for which shall be made to the publisher.

This product is not intended for use as a critical component in life support devices or any system in which failure could be expected to result in personal injury.

The product described in this manual and products for use with it are subject to continuous development and improvement. All information of a technical nature and particulars of the product and its use (including the information and particulars in this manual) are given by Acorn Computers Limited in good faith. However, Acorn Computers Limited cannot accept any liability for any loss or damage arising from the use of any information or particulars in this manual, or any incorrect use of the products. All maintenance and service on the product must be carried out by Acorn Computers' authorised dealers or Approved Service Centres. Acorn Computers Limited can accept no liability whatsoever for any loss or damage caused by service, maintenance or repair by unauthorised personnel.

If you have any comments on this manual, please complete the form at the back of the manual, and send it to the address given there.

Acorn supplies its products through an international distribution network. Your supplier is available to help resolve any queries you may have.

Within this publication, the term 'BBC' is used as an abbreviation for 'British Broadcasting Corporation'.
ACORN, ARCHIMEDES, the ACORN logo and ECONET are trademarks of Acorn Computers Limited
Apple is a trademark of Apple Computer Inc.
Atari is a trademark of Atari Corporation
Centronics is a trademark of Centronics Data Computer Corporation
Citizen is a trademark of Citizen Watch Co. Ltd. Japan
Eizo is a trademark of Eizo Corporation
Epson is a trademark of Epson Corporation
Ethernet is a trademark of the Xerox Corporation
LaserWriter is a trademark of Apple Computer Inc.
Multisync is a trademark of NEC Limited
NEC is a trademark of NEC Limited
Panasonic is a trademark of Matsushita Electric Industrial Co. Ltd
Philips is a trademark of Philips Electronics Ltd
PostScript is a trademark of Adobe Systems Inc.
Taxan is a trademark of Kaga Electronics Co. Ltd
All other trademarks are acknowledged.

Note: Various third party monitors and other peripheral equipment are depicted or described in this Guide. The illustration or description of these or any other third party equipment does not imply any recommendation or endorsement by Acorn Computers Limited, and users must satisfy themselves as to the suitability of any peripheral equipment (including monitors) on advice from the equipment supplier.

Published by Acorn Computers Limited
ISBN 1 85250 125 0
Part number 0492,250
Issue 1, April 1992

Guidelines for safe operation

The equipment described in this guide is designed and manufactured to comply with international safety standards EN60950 (BS7002) and is intended for use only as a desktop computer. It must not be used for other purposes. It is most important that unpacking and operation is carried out in accordance with the instructions given in this guide. In the interests of continued safe and reliable operation, observe the following guidelines:

- *Keep the machine at a room temperature of +5°C to +35°C (+41° to +95° Fahrenheit) and a relative humidity of 10% to 80% (non-condensing). As a rough guide, if you feel much too hot, cold or humid, the conditions are probably too extreme for the computer as well.*
- *Avoid sudden extremes in temperature, exposure to direct sunlight, heat sources (such as an electric fan heater) or rain.*
- *Make sure that the equipment is standing on a suitable rigid horizontal flat surface, allowing enough space for air to circulate when it is in use.*
- *Ensure that any wires and cables are routed sensibly so that they cannot be snagged or tripped over. Don't tug or twist any wires or cables, or use them to hang or lift any of the units.*
- *Make sure you have read and understood any installation instructions supplied with upgrade kits before attempting to fit them. If you have any doubts, contact your supplier.*
- *Keep the original packaging in case you need to transport the computer, and avoid bumping, jarring or dropping it in transit.*
- *Keep the plastic bags contained in the packaging away from children.*
- *If you're going to move the computer, make sure you park the hard disc first (if fitted). See Switching off the computer on page 61.*
- *If you re-pack your computer for any reason, be sure to put any leads back in their protective plastic bags (to stop any reaction between the leads and the polystyrene packing material if they are left in direct contact over a long period of time).*
- *Switch off and unplug the computer from the power outlet on the wall if you are not going to use it for any length of time (a couple of days, for example).*
- *Switch off and unplug the equipment and any accessories before opening the unit (to install an upgrade, for example).*
- *The main computer unit should be operated with the cover secured, to ensure the correct airflow through the unit. However, it can safely be switched on with the cover removed, as long as it is not left unattended, and provided that care is taken not to short circuit any connections or to allow any fingers or objects in the area of the fan or disc drives when these are running. Be especially careful with jewellery.*
- *DON'T attempt to open any display or monitor unit, whether supplied with the equipment or not.*
- *DON'T spill liquids on the equipment. If liquid does spill, turn the equipment off immediately and take it to your supplier for assessment.*
- *DON'T obstruct or poke objects through the ventilation openings in the computer casing or the power supply, or cover them with anything.*
- *DON'T exceed the maximum power consumption of 8 watts from each expansion card slot.*
- *DON'T balance any objects, or stand equipment weighing more than 25kg (55lbs) on top of this equipment.*

Warning: this equipment must be earthed

If the plug supplied is not suitable for the power supply in your country, please consult your supplier.

UK information

As the colours of the cores in the AC power lead of this equipment may not correspond to the coloured markings identifying the terminals in your plug, proceed as follows:

- The core which is coloured green and yellow must be connected to the terminal in the plug which is coloured green and yellow, or is marked by the letter E or by the earth symbol
- The core which is coloured blue must be connected to the terminal that is coloured black or marked with the letter N.
- The core which is coloured brown must be connected to the terminal which is coloured red or marked with the letter L.

The mains lead supplied is already fitted with a moulded plug incorporating a 5A fuse. If it does not fit your socket-outlet, the plug should be removed from the mains lead **and safely disposed of**. The flexible cord insulation should then be stripped back as appropriate. A suitable alternative plug should then be fitted. If the replacement plug is intended to take a fuse, then a 5A fuse must be used.

If you need to replace the fuse in the mains plug supplied, then you must use a 5A fuse ASTA-approved to BS1362.

Never use mains plugs with the fuse carrier omitted. In the event of the loss of the fuse carrier, either replace with a carrier of the same type and manufacturer or replace the moulded plug with another mains plug, wired as detailed above.

Guarantee (valid in UK only)

This equipment is guaranteed by Acorn Computers Limited ("ACORN") against mechanical and electrical defects subject to the conditions set out below.

Note

Items which by their nature or design only have a restricted life are not guaranteed beyond such life.

Period of validity

This guarantee shall be valid for a period of twelve (12) months from the date of purchase.

Other conditions

- 1 This guarantee is personal to the original purchaser, is not transferable and shall not be valid unless the equipment was purchased from ACORN or from an approved ACORN supplier.
- 2 This guarantee will be invalidated if the equipment is misused or damaged or is modified in any way without the written consent of ACORN or if any original component or accessory has been replaced by any component or accessory of a type not recommended or approved by ACORN, or if operated other than in accordance with the *Welcome Guide* and *RISC OS 3 User Guide*.
- 3 Any claims made under this guarantee must whenever possible be made through the supplier from whom the equipment was originally purchased. If this is not possible a claim may be made to any other approved ACORN supplier appointed by ACORN to service the equipment (a list of whom can be supplied on application). This guarantee together with proof of the date of purchase must be produced when any claim is made. Any costs of carriage to and from the supplier must be paid by the purchaser.
- 4 If ACORN agrees with the supplier that the equipment should be forwarded to ACORN for repair then ACORN will arrange for collection and return of the equipment at no charge. In all other cases the supplier will be responsible for effecting any necessary repairs in accordance with ACORN's service policy. Any repairs under this guarantee will be carried out at no cost to the original purchaser.
- 5 If any equipment returned is found to comply with its original specification ACORN reserves the right to charge a reasonable fee for testing the equipment and for return carriage.
- 6 The liability of ACORN under this guarantee shall be limited to the cost of repair or complete replacement (at ACORN's discretion) of equipment which proves to be defective.
- 7 ACORN does not accept liability for any loss or damage during transit to or from the supplier or ACORN, but every effort will be made to investigate claims of loss or damage if these arise.

THIS GUARANTEE DOES NOT AFFECT OR PREJUDICE THE PURCHASER'S STATUTORY RIGHTS.

Guarantee procedure

To claim under this guarantee, proof of date of purchase is required. This is provided by your copy of the invoice from the supplier from whom the equipment was originally purchased. Keep the invoice safe and produce it to support any claim you may make under this guarantee.

You may find it useful to make a note in the box below of the serial number, date of purchase and details of any upgrades you fit, and quote them in any correspondence.

Serial Number _____ Date of purchase _____

Upgrades _____

Contents

Part 1 - Getting started

The chapters in this part contain all the information you need to get started on your computer. The odd-numbered pages in this part are marked with a grey box on the top righthand side.

- Unpacking 1
Describes what you should find when you open the box containing your computer.
- Setting up the computer 3
Explains how to connect everything together.
- Switching on 7
Tells you how to turn the computer on and describes the display on the screen.
- The RISC OS desktop 11
Introduces the features of the RISC OS desktop.
- Using the mouse 13
Describes what the mouse does, and how to use it.
- Windows 17
Explains the special features of the screen display.
- Menus 25
Explains how menus work within the RISC OS desktop.
- Discs and disc drives 29
Tells you about floppy disc drives and hard disc drives.
- Using the keyboard 37
Introduces the keyboard and some of its features.
- Using applications 43
Tells you how to start running applications.
- Files and directories 47
Introduces the desktop filing system.
- Printing 55
Gets you started using a printer.
- Switching off the computer 61
Tells you how to switch off your computer after you've finished using it.
- If things go wrong 63
Offers solutions to some common problems you might encounter.

Part 2 - Hardware reference section

This part contains technical reference information and more detailed installation instructions, along with some advice on looking after your computer. The odd-numbered pages in this part also have a grey block on the righthand edge, but lower down than those in Part 1.

Appendix A: Maintaining your computer 67

Tells you how to look after your computer.

Appendix B: Monitor connections 69

Lists some commonly-used monitors, and describes how to connect them to your computer.

Appendix C: Attaching peripheral devices 77

Explains how to connect other devices to your computer, such as serial and parallel printers and modems.

Appendix D: Hardware components and connectors 81

Identifies the main hardware features of the computer, including the sockets on the back.

Glossary 87

Defines computer jargon used in this guide. Terms explained in the Glossary are printed in italics the first time they appear in the guide.

Index 93

Unpacking

This chapter tells you about unpacking your computer, and gives some hints on where to set it up.

Unpacking

Unpack your computer on a flat surface — either on the floor, or on a large table where there's plenty of room for the carton as well as for the computer. Take everything out of the carton, making sure you don't break the packaging material, as you may need this later.

Warning: the packaging contains plastic bags which can be dangerous to young children. Please keep them out of their reach.

Checklist

Check that you have received all the items shown below. If you don't have all of these items, or if any of them appears damaged, notify your supplier immediately.

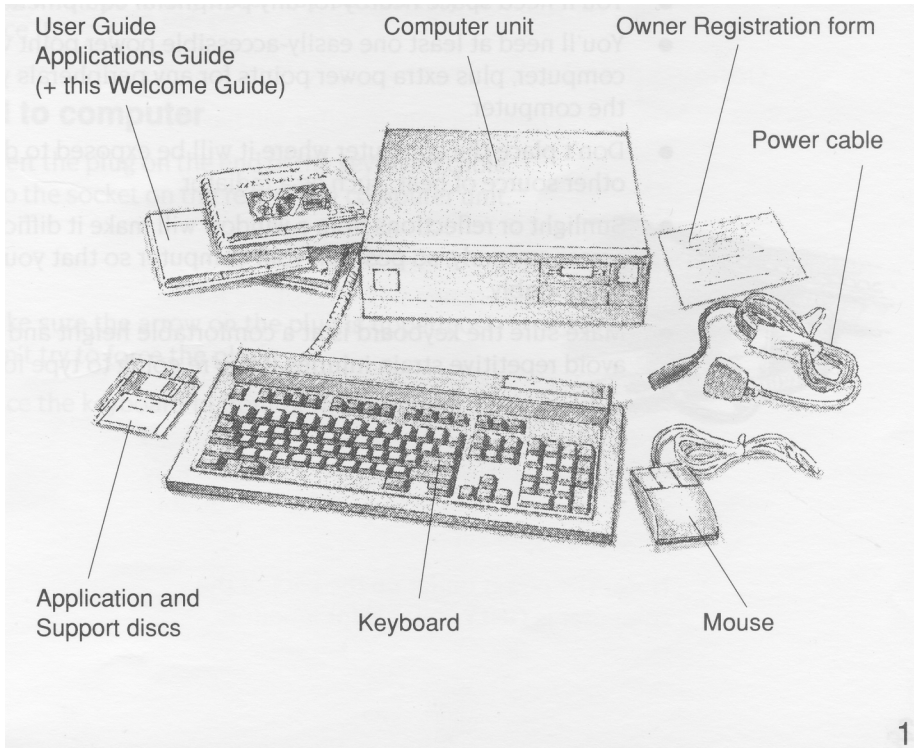

The *monitor*, if supplied with your model of computer, is in a separate box.

If you have bought any *peripheral* equipment to attach to your computer, such as a *printer*, check that your supplier has provided the correct cables (see *Appendix C: Attaching peripheral devices* if you're not sure).

Complete the Owner Registration Form and post it back to Acorn (purchasers outside the UK should send it to their local supplier or national distributor). This will enable us to inform you of new products and upgrades to your computer as they become available.

Put all the packing back into the carton and put it away somewhere safe. If you ever want to transport your computer, it is best to use the box, even if you only take it a short distance in a car. If you ever have to take it back to your supplier, too, you must pack it back into the original carton.

Choosing where to set up your computer

Bear the following points in mind when deciding exactly where to place your computer:

- You'll need a firm, flat surface with enough space at one side to move the mouse around, and space at the other side for manuals and papers you may be working on.
- You'll need space nearby for any peripheral equipment (such as a printer).
- You'll need at least one easily-accessible power point within 1.5 metres of the computer, plus extra power points for any peripherals you want to connect to the computer.
- Don't place the computer where it will be exposed to direct sunlight, or any other source of heat, such as a radiator.
- Sunlight or reflections from a window will make it difficult to see things on the screen properly, so position your computer so that you can see the screen comfortably.
- Make sure the keyboard is at a comfortable height and position for you to avoid repetitive strain injuries if you're going to type for long periods.

Setting up the computer

This chapter describes how to connect the components of the computer together and set it up ready for use. Before you start connecting it up, please read the Guidelines for safe operation in the front of this guide.

Connect mouse to keyboard

Take the *mouse* and the *keyboard* out of their plastic bags. The mouse has a straight cable with a plug on the end of it. This goes into the socket at the back of the keyboard.

The plug has an arrow moulded into it; this should be uppermost when you push it in. The plug won't go in any other way, so don't try to force it.

Connect keyboard to computer

Insert the plug on the end of the keyboard cable into the socket on the rear of the computer unit.

Make sure the arrow on the plug is uppermost. Don't try to force the plug.

Place the keyboard in front of the computer.

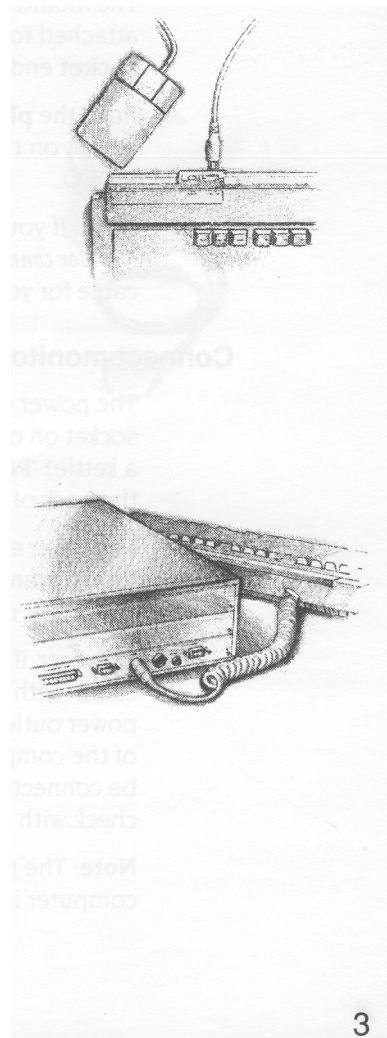

Connect monitor

You'll usually have two cables with each monitor:

- a signal cable (allows the computer and the monitor to 'talk' to each other)
- a power cable.

Connect monitor signal cable to computer

Put the monitor on top of the computer (unless you are using a monitor which weighs 25kg or more, in which case it will have to go alongside the computer unit, or on a strong shelf above it).

The monitor signal cable is usually permanently attached to the monitor. If it isn't, push the **socket** end into the back of the monitor.

Push the **plug** end of the monitor cable into the socket on the back of the computer marked **VIDEO**.

Note: If you have trouble, check in *Appendix B: Monitor connections* – you might need an adaptor cable for your particular monitor.

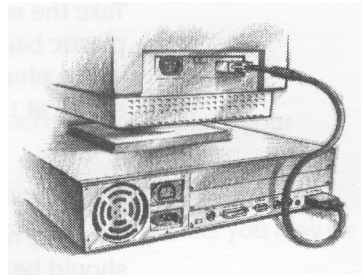

Connect monitor to power supply (but don't switch on yet)

The power cable for your monitor will have a socket on one end (like the type you connect to a kettle). Plug this into the power connector on the back of the monitor.

The other end of the monitor's power cable may have a standard power plug. If so, plug it into the power outlet on the wall.

However, if your monitor has an IEC-type power cable (with a **plug** on the end) plug this into the power outlet (marked IA 220-240V) on the back of the computer. (Not all types of monitor may be connected to this power outlet. If in doubt, check with your supplier.)

Note: The power outlet on the back of the computer is **ONLY** suitable for monitors.

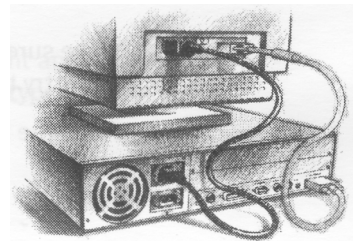

Connect other peripherals to computer

Connect any other peripherals you have (such as a printer or a modem) **before** you switch on the power. Most printers use the PARALLEL PRINTER port on the rear of the computer.

Appendix C: Attaching peripheral devices gives you some advice.

Connect other peripherals to power supply (but don't switch on yet)

Connect the power cables for any other peripherals to power outlets on the wall.

Connect computer to power supply

Finally, plug the connector on the computer power cable (the one that looks like the type you plug into a kettle) into the socket marked 2A 220-240V on the back of the computer unit. Plug the other end into the power supply outlet on the wall.

Don't switch on the power supply yet: follow the instructions in the next chapter.

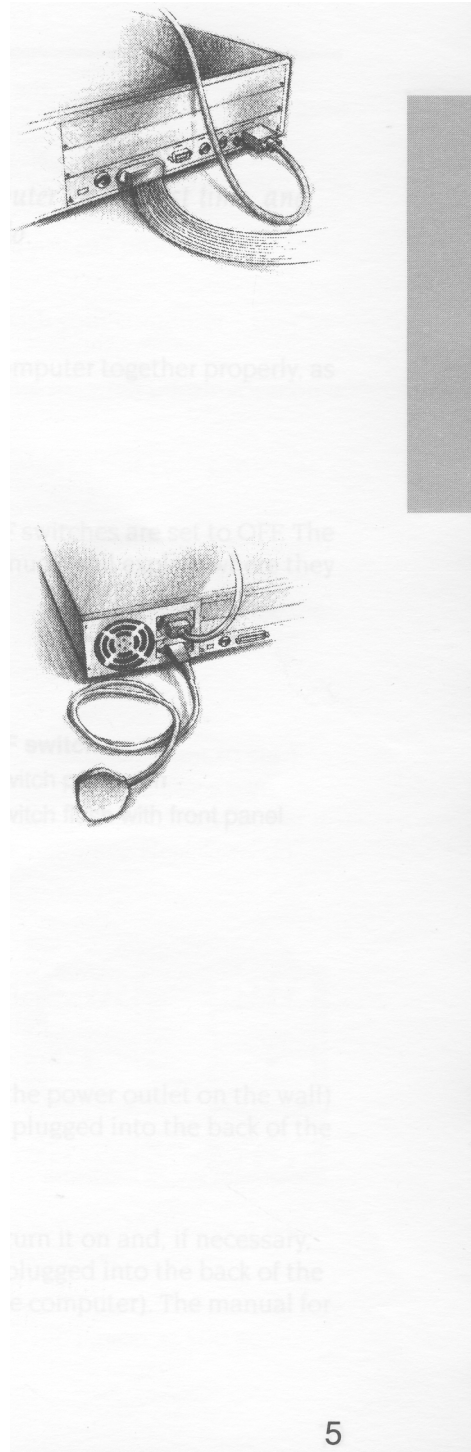

Switching on

This chapter tells you how to power up your computer for the first time, and describes what you see on the screen when you do.

Equipment check

First check that you have connected all parts of the computer together properly, as described in the previous chapter.

Before switching on the mains supply

Check that the monitor, printer and computer ON/OFF switches are set to OFF. The monitor and printer have separate switches. Their manuals will explain where they are.

The ON/OFF switch for the computer is on the front:

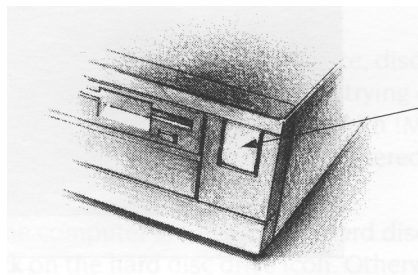

ON/OFF switch

ON: switch pushed in

OFF: switch flush with front panel

Switching on

- 1 Switch on the mains supply for the computer (at the power outlet on the wall) and that for the monitor (if its power cable is not plugged into the back of the computer) and printer (if you have one).
- 2 Switch on the monitor and printer.

The manual for your monitor will explain how to turn it on and, if necessary, adjust the brightness control. (If your monitor is plugged into the back of the computer, it won't come on until you switch on the computer). The manual for your printer will explain how to turn that on, too.

- 3 Switch the computer on, by pressing the ON/OFF switch on the front (the green LED on the lefthand side of the computer will light up).
Depending on your monitor (and whether it has warmed up yet) you might see the screen change colour while the computer performs some *self-tests*. The LED on the floppy disc drive will also flash once when the drive is being checked. Next, you will see an introductory screen:



After a few seconds, you should have a picture on your screen, looking something like this:

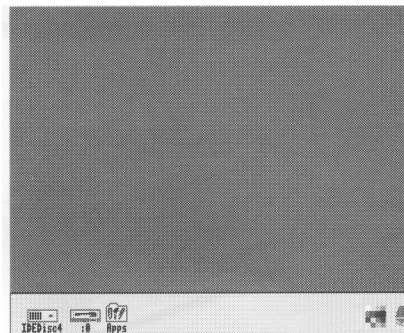

If the display does not look similar to that shown above (or if the floppy drive light flashes more than once) see *If things go wrong* on page 63.

What now?

Scenic route!

Now you're ready to begin using your computer. If this is the first time you've used a computer (or at least an Acorn computer) take the following route:

- 1 Use the rest of this guide to get used to the RISC OS *desktop*, and to learn how to use the computer efficiently. You'll need to know the basics explained here, whatever you use the computer for later, although you can probably do without this guide after a couple of weeks.
- 2 Try using some more of the programs supplied with your computer – they're described in the RISC OS 3 *Applications Guide*.
Check in the RISC OS 3 User *Guide* if you need more detailed information on a particular topic or technique.
- 3 Ask your supplier what other *applications* are available to suit your particular purpose.

If you want to stop for the moment, you can just switch off at the ON/OFF switch (and then switch off the monitor and any other peripherals too). Later on, when you've been using your computer a while, you'll find that it's better to follow the instructions in *Switching off the computer* on page 61.

Motorway route!

If you're familiar with computers, mice, discs and so on, and you want to start doing something right away, start by trying out some of the computer's own *applications*. For example, play a tune with !Maestro (this will sound even better if you listen through a pair of 'personal stereo' headphones – see *Headphones* on page 84):



- 1 If the computer is fitted with a hard disc, click on the hard disc drive icon. Otherwise put the Applications disc into the floppy disc drive and click Select (the lefthand mouse button) on the floppy drive icon.
- 2 Double-click Select on the App2 directory.
- 3 Double-click on the Tunes directory.
- 4 Double-click on Fanfare (for example).

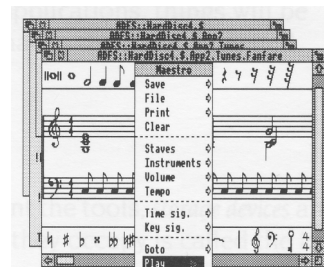

- 5 Click Menu (middle mouse button) over Fanfare's window to display a menu. Click Select on the **Play** option to start. Choose **Play** again to stop!

Don't despair if the above description sounds like it's written in a foreign language – just take the scenic route instead, and you'll pick up the jargon as you go.

The RISC OS desktop

An introduction to the desktop environment of RISC OS.

The RISC OS desktop

RISC OS is the name of the *operating* system of your computer, which controls the way the computer appears to you, and how it does other things. There's more on this subject in the RISC OS 3 *User Guide*, if you're interested.

By now, you should have successfully powered up your computer, and be able to see the RISC OS *desktop* on your screen.

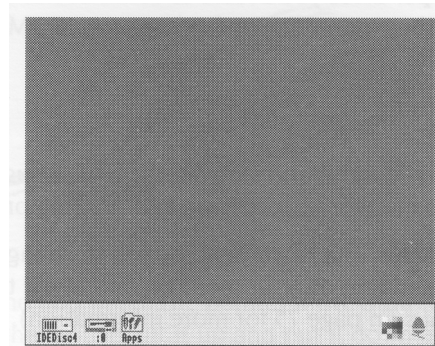

The desktop is your working area. At first it is clear, except for the bar across the bottom of the screen. As you perform tasks and use applications, things will be added to the desktop. You can move them around, change their size, hide and remove them to make room for others.

Icons

The pictures in the lower margin of the screen represent the tools, *storage devices* and applications available. They are called *icons*. The area they occupy is called the *icon bar*.



(Your icon bar may have more icons on the lefthand side — see overleaf).

Device icons

The icons on the left of the icon bar represent the *devices* which are available — that is, the discs and other places where you can load information from, and save it to. At least one will appear on the icon bar:



Floppy disc drive. The computer uses 3.5 inch *floppy* discs, which you put into the slot in the front of the computer. Floppy discs are described in *Discs and disc drives* on page 29.



Hard disc drive (if fitted). There is more about *hard* discs in *Discs and disc drives* on page 29.



Net (if fitted). If your computer is fitted with a *local area network* interface, there will also be a Net icon.



Apps. Gives you access to some useful applications which are permanently stored in the computer's *read-only memory* (ROM).

Applications icons

On the righthand side are the *applications icons*. These represent things you can do, such as word-processing and drawing programs. Initially there are only two:



Palette. The *palette* enables you to change the colours or grey scales on the screen, depending on your monitor, and to set the *screen mode* (see *MonitorType and screen modes* on page 75 for more information).



Task manager. The *Task manager* enables you to look at and control the allocation of your computer's memory, amongst other things. More information on this is given in the RISC OS 3 *User Guide* in the chapter entitled *Fine tuning the configuration*.

Any other applications which you load will normally be represented by icons on the righthand side of the icon bar.

The pointer



The arrow on the screen is the *pointer*. It is used to point at things you want to use or move.

You move the pointer across the screen by moving the mouse.

There are other types of pointer, which you will come across as you become more familiar with your computer.

Using the mouse

This chapter tells you how to use the mouse to select and move things displayed on the screen. It is your principal means of communicating with the desktop.

Holding the mouse

Hold the mouse with the cable away from you so that your fingers rest easily on the three buttons. If you are right-handed, you should hold it like this:

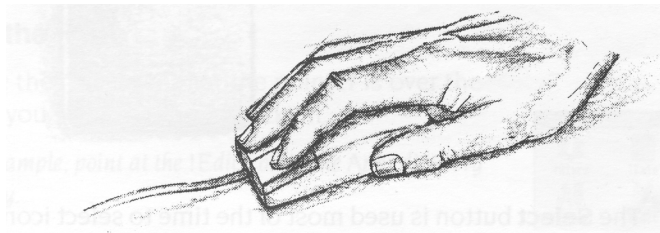

Move the mouse around and watch the pointer move around the screen. If you run out of space to move the mouse, lift it up and put it down again in a more convenient position. While the mouse is lifted, the pointer will not move, and when you put it down again you can carry on where you left off.

Use the mouse on a smooth but non-slippery surface. A mouse mat (available from your supplier) is ideal. Other surfaces on which the mouse works well are wood and glass.

The mouse will not work well on painted metal or highly varnished surfaces.

The mouse buttons

The mouse has three buttons, known as *Select*, *Menu* and *Adjust*:

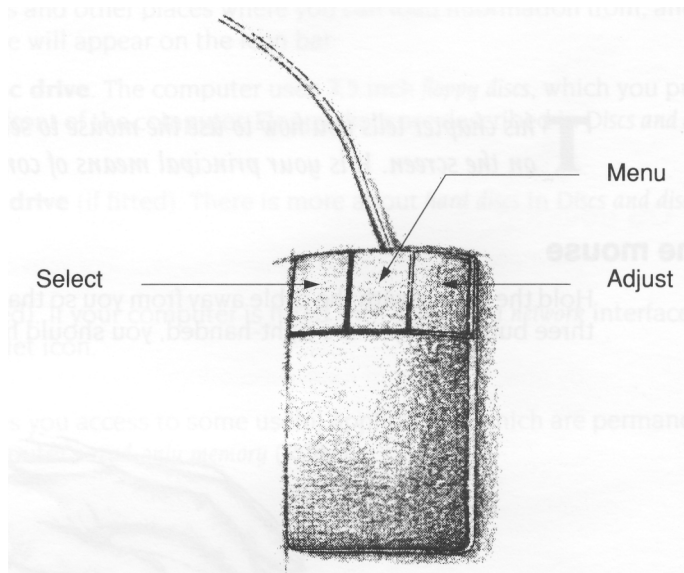

The **Select** button is used most of the time to select icons displayed on the screen, or to choose from menus.

The **Menu** button makes a *menu* appear. Menus are described in *Menus* on page 25.

The **Adjust** button does a variety of things, mostly useful variants of what the Select button does. *Keeping a menu on the screen* on page 27 includes one instance, and the RISC OS 3 User *Guide* describes many more.

Mouse techniques

The following mouse techniques are all you need to start using your computer:

clicking – pressing the mouse button just once and then releasing it immediately.

double-clicking – pressing and releasing twice in quick succession. This is used to initiate an action, or to load an application, for example.

dragging – moving an object from one place to another whilst holding down the Select (or Adjust) button.

Clicking and dragging techniques are summarised on the following pages.

Clicking

1 Point at the icon

Move the mouse so that the pointer is over the item you want to select.

For example, point at the Apps icon on the icon bar.

2 Click Select

Press and release the Select (lefthand) button of the mouse.

The Apps directory display will appear.

Double-clicking

1 Point at the icon

Move the mouse so that the pointer is over the item you want to double-click on.

For example, point at the !Edit icon in the Apps directory display.

2 Double-click on the icon

Press and release the Select (lefthand) mouse button twice in quick succession.

You have to make the second click while the second little arrow (the *double-click arrow*) which appears on the pointer after the first click, is still visible. If the item is highlighted but nothing else happens, try again, but double-click a little faster. Try not to move the mouse while you're doing this.

The Edit icon will appear on the icon bar, showing that the Edit application has been loaded ready for use.

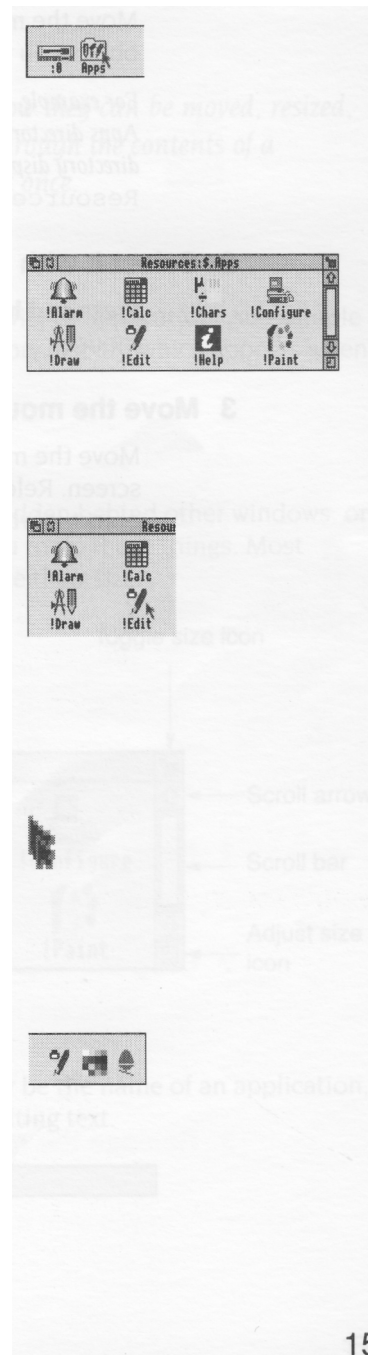

Dragging

1 Point at the object

Move the mouse so that the pointer is over the object you want to move.

For example, point at the title bar along the top of the Apps directory display. (The title bar is the part of the directory display containing the words Resources:\$.Apps)

2 Select it with the mouse

Press **and hold down** the lefthand button of the mouse.

3 Move the mouse and drag the object

Move the mouse to drag the object across the screen. Release the mouse button when the object is where you want it.

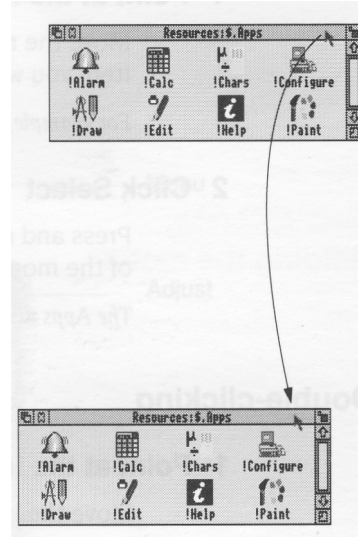

Windows

This chapter describes windows and explains how they can be moved, resized, hidden and closed. It describes how to move through the contents of a document too large to display in one window all at once.

What is a window?

A *window* is an area of the screen displaying an activity or application. An example of a window you have seen so far is the Apps directory display, which appears when you click on the Apps icon on the icon bar.

Features of windows

Most windows can be moved around the screen, hidden behind other windows, or closed completely. Icons on the windows allow you to do these things. Most windows also have icons which allow you to change their size.

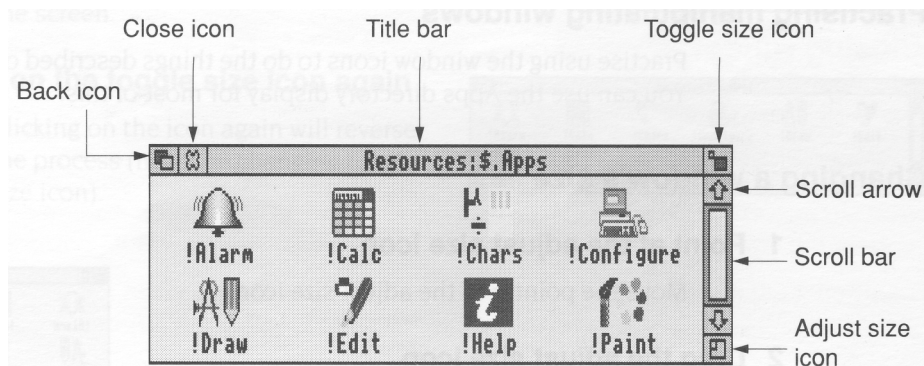

Title bar

The *title bar* displays the title of a window. This may be the name of an application, directory, or the name of a document if you are editing text.

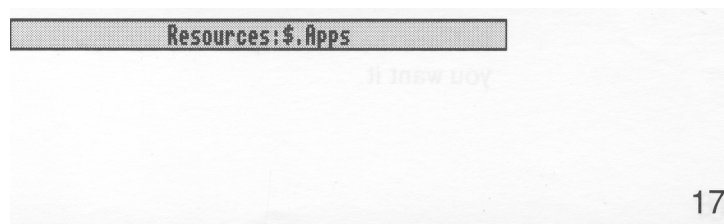

Back icon



Clicking on the *back icon* has the effect of putting a window to the back of the pile of windows on the screen. If you click on this, the window will be hidden behind any windows which overlap the area it occupies.

Close icon



Clicking on the *close icon* closes a window. If you click on this, the window will be removed from the screen.

Toggle size icon

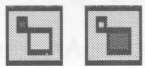

Clicking on the *toggle size icon* switches a window between full size and the last size displayed. (Full size is either large enough to display everything in the window, or such that the window fills the whole screen.)

This alternating action is called *toggleing*.

Adjust size icon



Dragging the adjust size *icon* lets you alter the size and shape of a window. Clicking the Select button on it also brings a window to the front of a stack of windows.

Practising manipulating windows

Practise using the window icons to do the things described on the following pages. You can use the Apps directory display for most of this.

Changing a window's size

1 Point at the adjust size icon

Move the pointer to the adjust size icon.

2 Drag the adjust size icon

Press and hold the Select button down. Move the mouse and drag the icon to change the size of the window.

3 Release the mouse button

Release the button when the window is the size you want it.

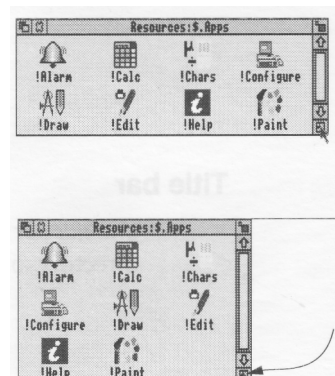

Moving a window

You move a window by dragging its title bar — follow the steps in *Dragging* on page 16.

You can drag windows almost off the screen (! Configure in the RISC OS 3 User Guide tells you how to set up the computer to do this).

If you've dragged a window so it obscures the icon bar, hold down the Shift key on the keyboard and press the F12 key. This will bring the icon bar to the front. (Press the same key combination again to send it to the back — this is another instance of toggling).

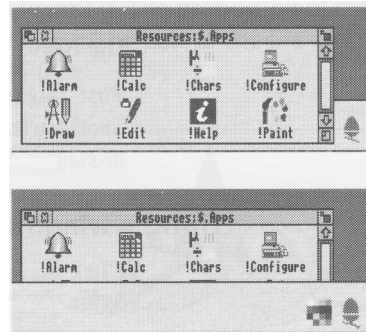

Toggling window size

1 Click on the toggle size icon

Move the pointer over the toggle size icon and click the Select (lefthand) button.

The window size will snap to nearly the width of the screen.

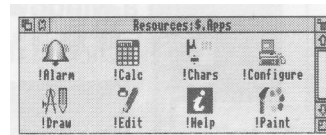

2 Click on the toggle size icon again

Clicking on the icon again will reverse the process (note the changing toggle size icon)

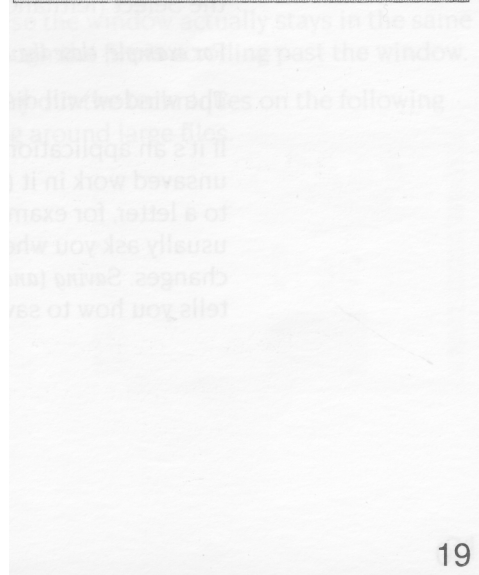
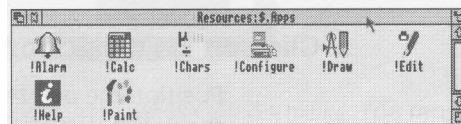

Bringing windows to the front

When you have a stack of windows on the screen, you can get at the one you want by sending windows to the back or bringing one to the front.

First, *click on the palette icon on the icon bar to bring up another window. Drag it on top of the Apps directory display.*

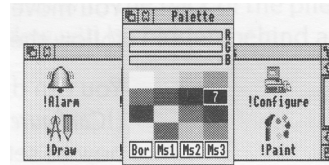

Bring a window to the front

Click on the title bar to bring a window to the front.

(**Note:** If you want to drag a window without bringing it to the front of a stack, use Adjust instead of Select.)

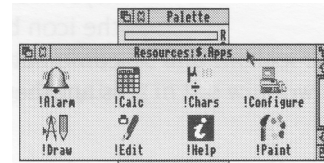

Send a window to the back

Click on the back icon to send a window to the back again.

Closing windows

Click on the close icon

Position the pointer on the close icon and click the Select (lefthand) button.

For *example, close the Apps directory display.* The window will disappear from the screen.

If it's an application window, and has some unsaved work in it (some changes you've made to a letter, for example) the application will usually ask you whether you want to save the changes. *Saving (and loading) a file* on page 50 tells you how to save files.

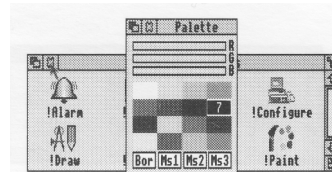

Scrolling

A window is so named because it allows you to see all or part of a file, application or whatever you've displayed on the screen. If, for example, a file is too large to display all at once, the window will only show a section of it. The proportion of the file visible depends on the size and shape of the window. The part of the file you can see alters as you move the window around the file:

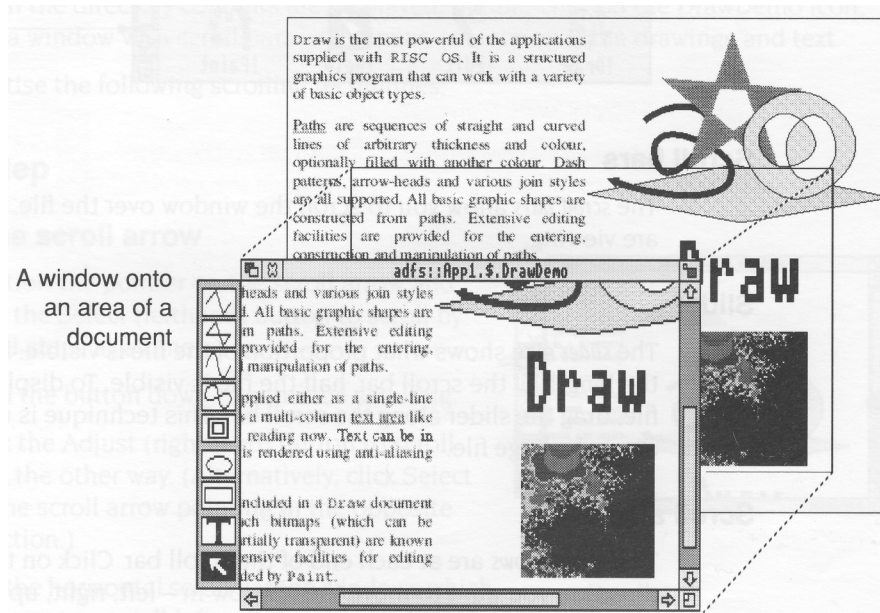

The technique of moving the window around a large file is called *scrolling*. You move the window frame over the file, but because the window actually stays in the same position **on the screen**, it appears as though the file is scrolling past the window.

This is not as complicated as it sounds. Try out the techniques on the following pages, and you'll soon get used to moving around large files.

Most windows have scroll bars and scroll arrows to enable you to move around a file:

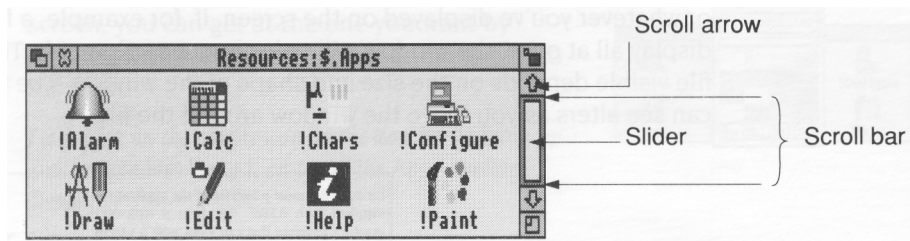

Scroll bars

The *scroll bars* allow you to scroll the window over the file, directory or picture you are viewing.

Slider

The *slider* size shows what proportion of the file is visible: if the slider occupies half the length of the scroll bar, half the file is visible. To display a different area of the file, drag the slider along the scroll bar. This technique is useful for moving quickly around a large file.

Scroll arrows

The *scroll arrows* are at each end of the scroll bar. Click on the arrow showing the direction you want to move the window in — left, right, up or down. This technique allows you a finer control over scrolling than dragging the slider.

Some windows (like the one above) only have vertical scroll bars, sliders and scroll arrows. Others have both vertical and horizontal scroll bars.

Practising scrolling

Insert the Applications disc supplied with your computer and click on the floppy disc drive icon to show the directory display for this disc. Then double-click on the App 1 directory. Alternatively, if your computer has a hard disc, double-click on the App 1 directory on the hard disc directory display. If you're not sure about any of this, read the chapter *Discs and disc drives* first, then come back to this.

When the directory contents are displayed, double-click on the DrawDemo icon, and a window with scroll bars will appear, containing some drawings and text.

Practise the following scrolling techniques:

Scrolling step by step

Click on the scroll arrow

Position the pointer on the scroll arrow and click the Select (lefthand) button to scroll by small steps at a time.

Hold the button down to continue scrolling.

Click the Adjust (righthand) button to scroll back the other way. (Alternatively, click Select on the scroll arrow pointing in the opposite direction.)

Use the horizontal scroll bar (on windows which have one) to scroll left or right, column by column, in the same way.

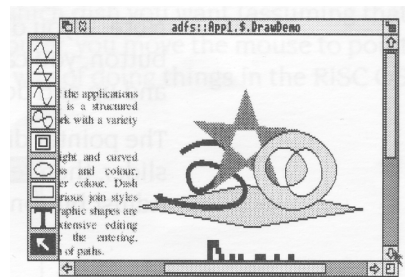

Scrolling screen by screen

Click on the shaded part of the scroll bar

Position the pointer on the shaded part of the scroll bar (above the slider to scroll up, below the slider to scroll down) and click the Select (lefthand) button.

The next screen of the document will appear.

Click the Adjust (righthand) button to scroll back the other way.

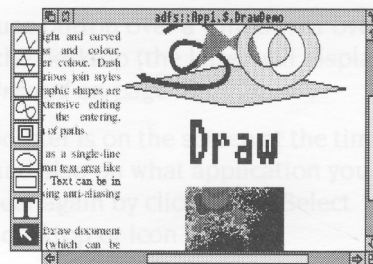

Moving through a file

1 Select the slider

Position the pointer on the slider, press the Select (lefthand) button **and keep it pressed down**

2 Drag the slider

Drag the slider to display the part of the file you want to view.

Move from one **side** of a document to the other by using the horizontal scroll bar (if the window has one).

Note: If you drag either slider with the Adjust button, you can move both from side to side and up and down. Try it.

The pointer disappears while you're dragging a slider, then reappears when you release the Adjust button.

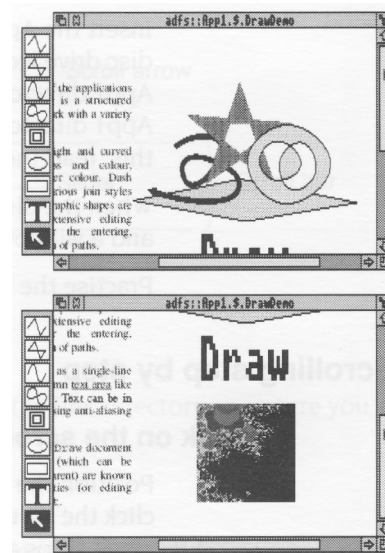

Menus

This chapter tells you what menus are, how to display them and choose things from them, and how to type in answers when the computer asks you to be more specific about what you want.

What is a menu?

A menu in the desktop is similar to a menu in a restaurant — it's a list of things to choose from. In a foreign restaurant, if you can't speak the language, you can point at the menu with your finger to tell the waiter which dish you want (assuming that you know what the menu means!). On the computer, you move the mouse to point at your choice from the menu. This is the main way of doing things in the RISC OS desktop.

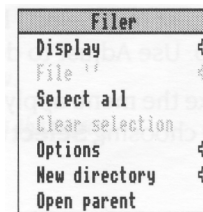

Menu options shown in grey (like **Clear selection** above) are not available at that time. Often you must perform another action before the option becomes available.

Using menus

To display a menu, click the Menu (middle) mouse button over a window, or over an icon on the icon bar, or over a blank area of the desktop (the latter will display the Pinboard menu — see the section entitled *Pinboard* on page 53).

The menu displayed will depend on where the pointer is on the screen at the time, whether you have previously selected an icon, and also on what application you are using. You can usually make a menu disappear again by clicking the Select (lefthand) mouse button on a blank area of the desktop or icon bar.

Displaying a menu

1 Point to the relevant icon

Move the pointer over the window or icon you want to work on.

For example, click on the Apps icon on the icon bar and move the pointer over the Apps directory display.

2 Click the Menu (middle) button

A menu will be displayed (*the Filer menu in this example*).

If the pointer is over a file icon when you click the Menu button (or if you had previously selected an icon by clicking on it) the menu will apply to that individual file.

You can make the menu apply to more than one icon in a window by clicking on each icon in turn with Adjust (not Select) before you bring the menu up. Use Adjust to deselect icons, too.

You can make the menu apply to all the icons in a window by choosing **Select all** from the menu — see below.

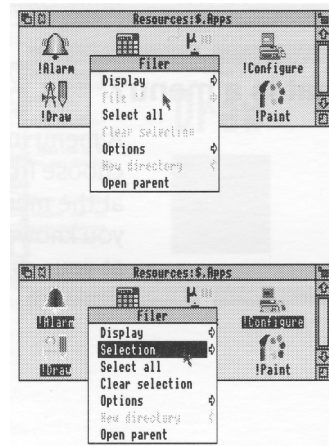

Choosing from a menu

Highlight the menu item you want and click on it

Display a menu, then move the pointer over the menu. Notice that menu items are highlighted as you move the pointer over them. Click Select on the item you want.

*For example, display the Filer menu over the Apps directory display. Point at the **Select all** option and click the Select button. All the file icons in the directory display will be highlighted.*

*To reverse this, repeat the above process, choosing **Clear selection** instead. Alternatively, click on the background of the directory display.*

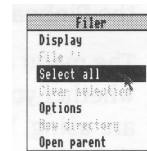

Keeping a menu on the screen

You'll notice that after you click **Select** to choose a menu option, the menu then disappears.

If you click with the Adjust (righthand) button instead of **Select**, the menu will stay on the screen, and you can choose another option.

Choosing from a submenu

1 Highlight the main menu item

Move the pointer onto a main menu item with an arrow. An arrow indicates that a *submenu* is available.

For example, point at the **Display** option on the **Filer** menu.

2 Display the submenu

Move the pointer onto the arrow.

The **Display** submenu will appear on the screen.

3 Click on the submenu item

Highlight and make your submenu choice by moving the pointer over it and clicking on it.

Click on **Small icons**. The icons in the directory display will change size.

You can also use the !Configure application to set the size at which the computer displays icons. See the *RISC OS 3 Applications Guide*.

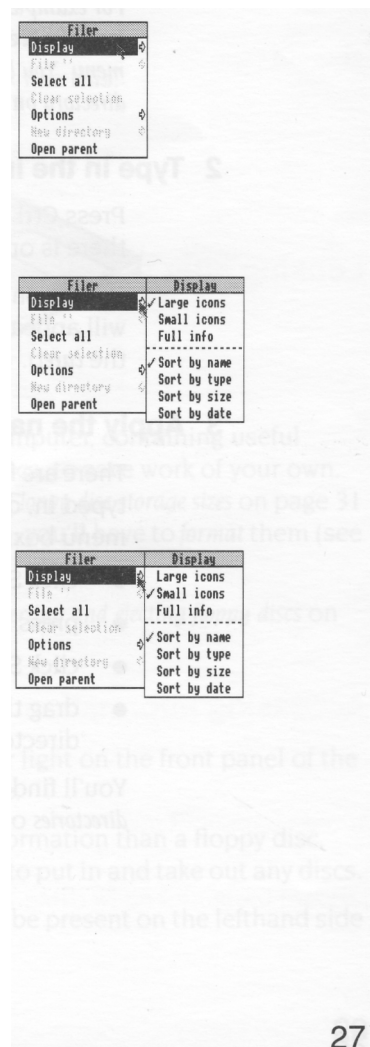

Writable menu boxes

Some submenus include *writable menu boxes*. They prompt you to type in information, such as a filename. Some boxes are blank. Others include a default name, which you can change if you want to.

To erase the default name, press the Delete key until it has gone. (A quicker way is to hold down the Ctrl key and press U.)

Two types of writable menu box

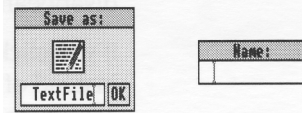

1 Display the writable menu box

For example, one of the boxes shown above is a submenu from the **New directory** menu option in the *Filer* menu. You'll find out how to display it in *Creating a new directory* on page 49.

2 Type in the information requested

Press Ctrl U to remove the default name, if there is one.

Decide on a new name and type it in. The text will appear to the left of the vertical bar (called the *caret*).

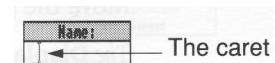

3 Apply the name

There are four ways of applying the name you've typed in, depending on the type of writable menu box:

- click Select on the name
- press Return
- click Select on the OK box
- drag the file's icon from the menu box to a directory display.

You'll find out more about this in *Files and directories* on page 47.

Discs and disc drives

This chapter tells you how to use and take care of your discs and disc drives, and how to format and make backup copies of discs.

Floppy discs and hard discs

You store information and programs on hard or floppy discs.

Floppy discs

Your computer uses 3.5 inch floppy discs. They look like this:

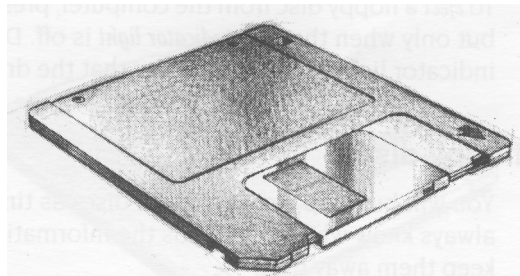

A number of floppy discs are supplied with your computer, containing useful programs. You will also need some blank floppy discs, to save work of your own. You can obtain these from your computer supplier. *Floppy disc storage sizes* on page 31 tells you which discs to ask for. Before you use them, you'll have to *format* them (see *Formatting a floppy disc* on page 32).

You put the discs into the floppy disc drive (see *Inserting and ejecting floppy discs* on page 30). The drive can only take one disc at a time.

Hard discs

A hard disc is fitted to some computers. The amber light on the front panel of the computer will come on when the hard disc is active.

Hard discs are much faster and hold a lot more information than a floppy disc. They are built into the computer, so you don't have to put in and take out any discs.



If a hard disc is fitted to your computer, its icon will be present on the lefthand side of the icon bar.

Inserting and ejecting floppy discs

The floppy disc drive is on the front of the computer.

Insert the disc into the floppy disc drive like this, with the label uppermost:

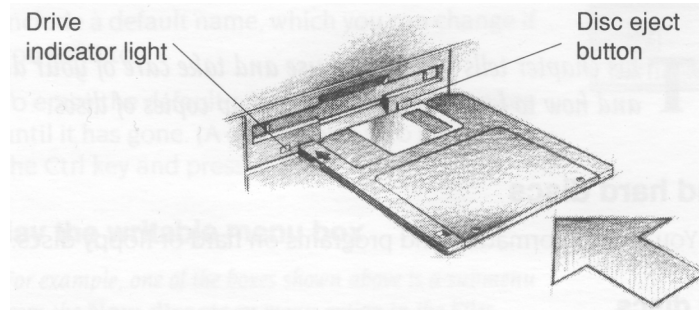

The disc clicks into place when it is fully inserted.

To *eject* a floppy disc from the computer, press the *disc eject button* below the disc slot, but only when the *drive indicator light* is off. Don't try to eject a disc when the drive indicator light is on; it indicates that the drive is still running.

Looking after floppy discs

You will build up a collection of discs as time passes. Label them so that you always know which one holds the information you need. Store them carefully and keep them away from

- extremes of temperature
- strong magnetic fields (e.g. TVs or loudspeakers)
- dust, dirt, drinks, pets etc.

Don't open the metal shutter on the disc, as the disc surface is easily contaminated by dust and small particles. For this reason, it's not a good idea to write on the labels in pencil: small pieces of pencil lead can easily get onto the disc surface.

Accessing information on discs

To gain access to the information contained on a floppy disc which has been inserted into the drive, or on a hard disc, click *Select* on the relevant disc drive icon on the icon bar.

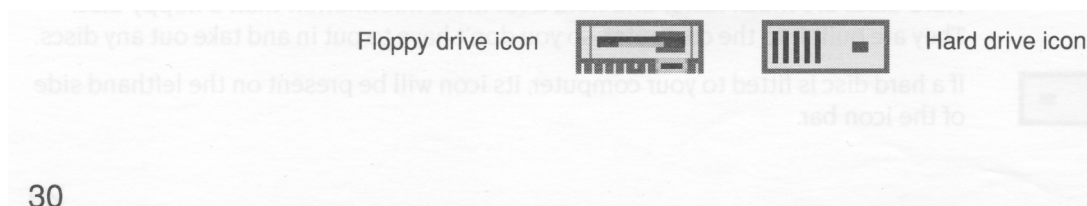

The contents of the disc will be displayed in a directory display:

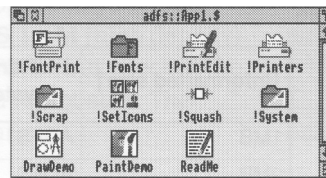

Write-protecting a floppy disc

If you *write-protect* a disc, it means that you cannot change anything on the disc, delete anything by mistake, or save any new files to the disc. You should write-protect discs containing any information you don't want to lose (and don't want to change at present).

To write-protect a disc, move the plastic tab (on the underside of the disc) towards the edge of the disc with your finger nail:

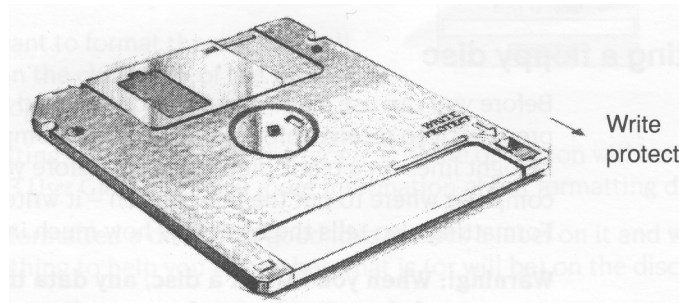

Remove write-protection by moving the tab back again.

Floppy disc storage sizes

Double density



High density

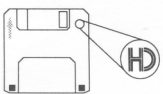

(extra hole)

Floppy discs are a bit like audio cassettes — they both store (or record) information. Some audio cassettes hold more information than others (for instance, a C90 holds more than a C60) even though they are the same physical size.

This is the same for floppy discs — the discs your computer uses are all 3.5" in diameter, but are available in different storage sizes. You can use the following sizes of floppy disc with your computer:

- *double density* floppy discs, holding 800 *kilobytes* (800KB) when formatted (Acorn ADFS 800K (E) format)
- *high density* floppy discs, holding 1.6 *megabytes* (1.6MB) when formatted (Acorn ADFS 1.6M format).

Your computer can also format discs for filing systems other than ADFS, as shown in the following table. To ensure reliability only format discs in accordance with this table.

Unformatted size#	Filing system	Formatted size	Density	
1MB	ADFS	800KB	double	DD
2MB	ADFS	1.6MB	high	HD
1MB	ADFS	640KB	double	DD
2MB	DOS	1.44MB	high	HD
1MB	DOS	720KB	double	DD
1MB	Atari	720KB	double	DD
1MB	Atari	360KB	double	DD

#-Note: Formatting a disc reduces its size, as the formatting information takes up some space on the disc. See the following section for a description of formatting a disc.

Formatting a floppy disc

Before you can use a new floppy disc, you need to format it. Formatting a disc prepares it to receive information from the computer. This is rather like drawing straight lines on a blank piece of paper before you start writing on it. It tells the computer where to put the information — it writes along the lines (called *tracks*). Formatting also tells the computer how much information a floppy disc can hold.

Warning!: When you format a disc, any data that was previously stored on it is permanently lost. So, don't reformat a disc unless you are certain that you no longer require the data stored on it.

1 Insert the disc in the floppy disc drive

2 Display the Format submenu

Move the pointer over the floppy disc drive icon on the icon bar, and click Menu.

Move the pointer to the right of the **Format** option, to display the Format submenu.

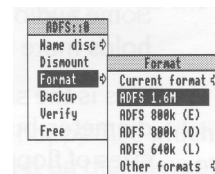

3 Click on the format you want

Choose the format appropriate to your disc. You'll probably want **ADFS 1.6M** (high density) or **ADFS 800K (E)** to start with, but check in the RISC OS 3 User Guide if you're not sure. The Format window will appear:

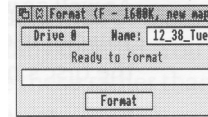

4 Decide on a name for your disc

Click Select on the **Name:** box and press Ctrl U (hold down Ctrl and press U) to delete the default name. Then type in the name you've decided on. (See *Renaming a floppy disc* on page 34 for more information on disc names).

5 Format the disc

If you're sure you want to format the disc, click on the **Format** box.

If you don't want to format the disc after all, simply click on the close icon of the window to abandon the operation.

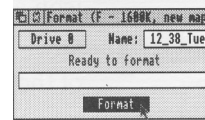

During formatting, an indication of the progress of the operation will be displayed. The RISC OS 3 User *Guide* gives you more information about formatting discs.

When you've formatted a disc, it's a good idea to stick a label on it and write on a name — something to help you remember what is (or will be) on the disc.

Disc errors

If, while formatting is in progress, you get a message that looks like this

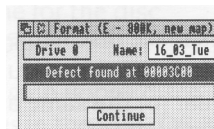

then the chances are your floppy disc is faulty. If you click on **Continue**, the computer will attempt to 'map out' any defects. You can use a disc with such defects, but there's always the chance it may prove faulty in the future, so if you can afford to it's probably best if you throw the disc away and use another one.

Renaming a floppy disc

As well as writing the disc's name on a sticky label so that **you** know what it's called, you can use the computer to name the disc electronically (so the **computer** knows the disc's name too).

If you don't choose names for your floppy discs when you format them, the computer will give them default names of the form 12_43_Tues. It's a good idea to give your floppy discs names which will help you remember what's on them (like BankLetter or Some_Pics).

Take the following steps to rename a floppy disc:

- 1 Make sure the disc you want to rename isn't write-protected.
- 2 Put the disc into the floppy disc drive.
- 3 Move the pointer over the floppy disc drive icon and click Menu.
- 4 Move the pointer over the arrow to the right of the **Name disc** option.
- 5 Type the new disc name in the **Disc name** writable menu box that appears.

Note: The name must be at least 2 characters up to a maximum of 10, but you can't use any spaces, or the characters \$ & % @

\ ^ : . # * " | .

- 6 Click Select on the name, or press Return.

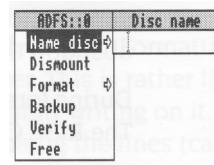

The disc now has a new name. To see it, click Select on the floppy disc drive icon on the icon bar. A directory display will appear, with the new name in the title bar. Remember to write the disc's name on its label.

Note: Always make disc names unique. You won't then get confused if the computer asks to see a particular disc. Also, make the name you physically write on the disc similar (or the same as) the electronic name you type in when you rename a disc.

Making backup copies

It is a good idea to make a *backup* copy of any valuable files or discs from time to time, in case a disc is damaged or a file is accidentally deleted. You should also make backup copies of your program discs, and use these rather than the originals, which you should keep safe.

Backing up a floppy disc

You'll need a blank disc (known as the *destination disc*) on which to make the backup copy. You can either use a brand new disc, or one that has been used before. You'll need to format a new disc before you can use it as a backup disc. It must be the same format as the *source disc*.

Take the following steps to make a backup copy of a floppy disc:

- 1 Write-protect the *source disc* and put it into the floppy disc drive.
- 2 Click Menu on the floppy disc drive icon on the icon bar, then click on the **Backup** option. You'll see the Backup window.
- 3 Click on **OK**. The computer will read the source disc.
- 4 Follow the rest of the instructions until backing up is complete—the computer will ask you to swap the source disc and destination disc while it transfers information between them (click on **Continue** each time you've done it).
- 5 Click on **OK** when the backup is complete.
- 6 Choose an appropriate name for the disc and write it on the disc's label.

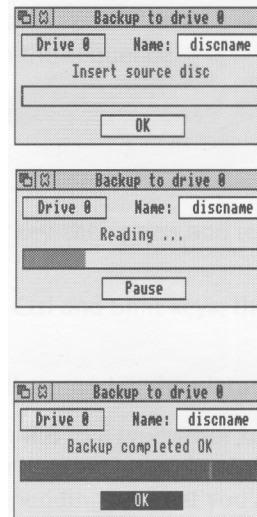

For more information on backing up floppy discs, and for quicker ways of doing it, see *Discs, networks and filing* systems in the RISC OS 3 User Guide.

Backing up files from a hard disc

If you have any files on your hard disc that you can't afford to lose, it's a good idea to keep backup copies of them on a floppy disc, in case your hard disc develops any errors. This can happen during the lifetime of a hard disc, but don't worry, it's not usually catastrophic! The RISC OS 3 User *Guide* tells you what to do if you do get any errors from your hard disc.

Format a blank floppy disc, and copy any important files from your hard disc onto it (see *Copying (and moving) a file to another directory* on page 51). Then rename your floppy disc to remind you what's on it.

Using the keyboard

This chapter describes the keyboard and its functions.

A quick tour of the keyboard

The illustrations in this chapter show how the keys are laid out on the keyboard. This chapter describes the main features of the keyboard, and tells you how to use the different groups of keys. **Note:** Sometimes you need to press more than one key to perform an action. In such cases:

- 1 Press **and hold down** all except the last key in the sequence.
- 2 Press and release the last key in the sequence.
- 3 Release all the other keys.

For example:

- Shift F12 means press and hold down the Shift key, then press and release F12, then release Shift.
- Ctrl Shift F12 means press and hold down the Ctrl and Shift keys, then press and release F12, then release Ctrl and Shift.

The keys are divided into the following blocks, as illustrated in the picture overleaf.

The *typewriter keys* are in the main block, and are similar to a typewriter keyboard. The Return key on the right completes a line, either starting a new line of text, or sending a name or instruction to the computer, depending on what you are doing. The *CapsLock key* (when its light is on) makes everything you type appear in capitals. If you don't want this, press the key once to make its light go out.

The *function keys* (marked F1 to F12) are in a row above the typewriter keys. The function of these keys in a particular piece of software is often marked on a keycard. You don't need to use these keys at the moment.

The *numeric keypad* is at the far right, laid out like a calculator. These keys can be used either to type numbers (when the NumLock light is on) or to perform special functions, depending on the program or application you are using.

The *Escape* key at the top left of the keyboard cancels an operation and may stop the running of an application.

The lefthand side of the keyboard

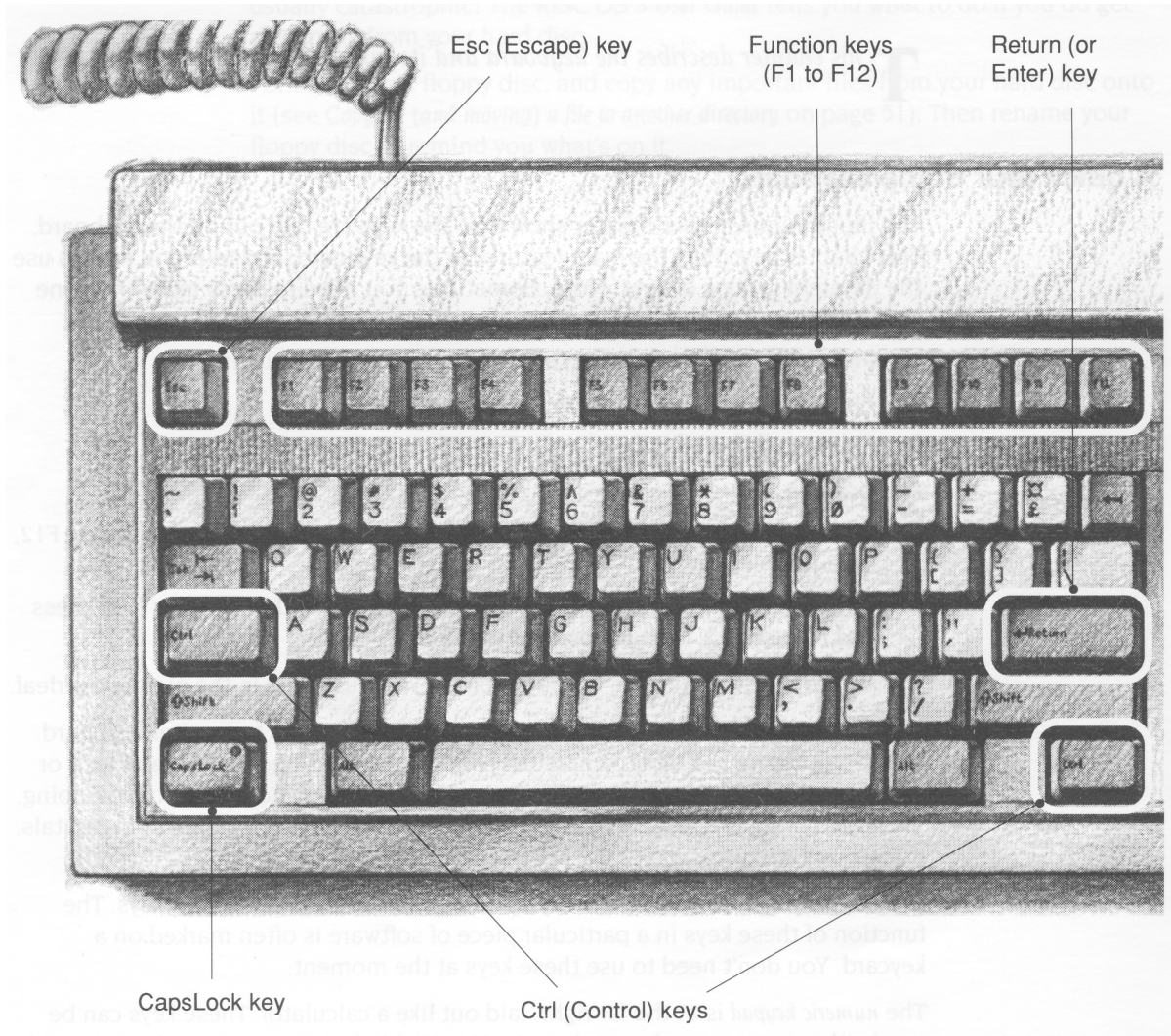

The righthand side of the keyboard

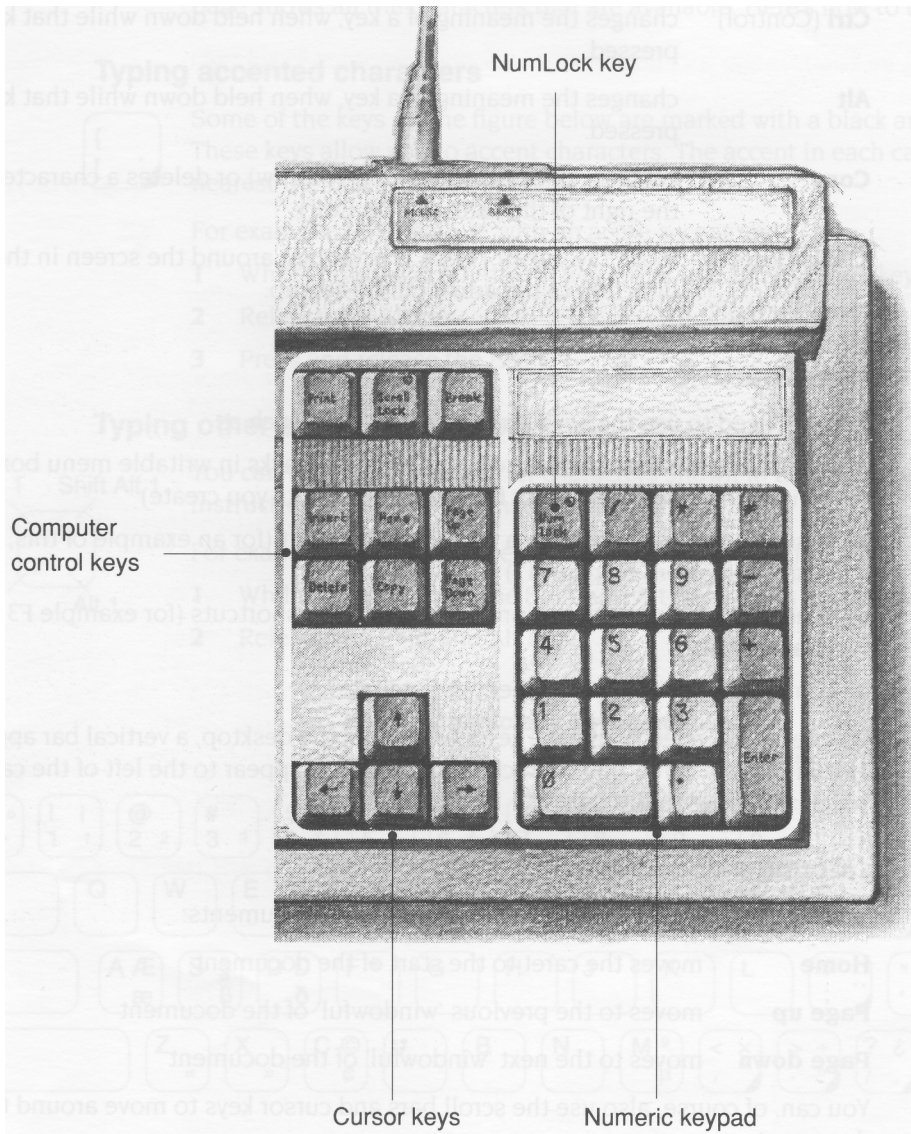

The *computer control keys* have different functions, depending on the software with which they are being used. Useful keys to know about at the moment are:

- | | |
|-----------------------|--|
| Delete | deletes a character to the left of the caret (e.g. in Edit) or deletes a selected object (e.g. in Draw). |
| Ctrl (Control) | changes the meaning of a key, when held down while that key is pressed. |
| Alt | changes the meaning of a key, when held down while that key is pressed. |
| Copy | copies a selected object (e.g. in Draw) or deletes a character to the right of the caret (e.g. in Edit). |
| Cursor keys | move the cursor (when it is visible) around the screen in the direction of the arrow on the keycap. |

When to use the keyboard

You will need to use the keyboard for many tasks, such as

- supplying answers to questions the computer asks in writable menu boxes (including giving names for files and documents you create)
- using a word processor, or a text editor like Edit (for an example of this, see *Using applications* on page 43)
- choosing some menu options using keyboard shortcuts (for example F3 to **Save** a file)
- entering data in a spreadsheet or database.

Whenever you need to use the keyboard within the desktop, a vertical bar appears. This is called a caret. Any characters you type will appear to the left of the caret, which will move to the right.

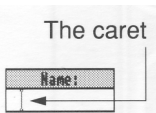

Moving around a document

Some other keys allow you to move around long documents:

- | | |
|------------------|---|
| Home | moves the caret to the start of the document |
| Page up | moves to the previous 'windowful' of the document |
| Page down | moves to the next 'windowful' of the document |

You can, of course, also use the scroll bars and cursor keys to move around the document.

Typing special characters

Sometimes you need to be able to type special characters that are not apparently on the keyboard, such as accented characters, or symbols like ©. You can in fact get at lots of extra characters using the Alt key. The keyboard map at the bottom of this page shows all the characters that are available. Here's how to type them:

Typing accented characters



Some of the keys on the figure below are marked with a black area in one corner. These keys allow you to accent characters. The accent in each case is the character nearest the black area of the key.

For example, to type an 'e' with an acute accent (é):

- 1 Whilst holding down the Alt key, press and release the I key.
- 2 Release the Alt key.
- 3 Press and release the E key.

Typing other special characters

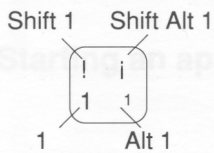

You can type the other special characters shown in the keyboard map using the instructions shown in the inset on the left.

For example, to type an inverted exclamation mark (¡):

- 1 Whilst holding down the Shift and Alt keys, press and release the I key.
- 2 Release the Shift and Alt keys.

Special characters: keyboard map



Using applications

This chapter tells you how to load and run applications on your computer. It uses the application *Edit* as an example.

What are applications?



Applications, like *Edit* or *1st Word Plus*, are programs. They are the tools that you use to produce your letters, drawings, music and so on. You can always tell applications, because their directory names start with an exclamation mark (!). See the next chapter for more information on application directories.

Some applications (such as *Edit*) are provided in the *Apps* directory on the icon bar, others are in the *Applications* suite on disc. Many other applications (like *1st Word Plus*) and games are available from your supplier.

Starting an application

There are two main ways you can start an application:

- Double-clicking – move the pointer over the application's icon, and double click.
- Dragging – move the pointer over the application's icon, then drag it onto the icon bar, and release.

You can also start an application if the computer has already 'seen' it by double-clicking on an associated file (e.g. double-clicking on a *Draw* file will start *Draw*).

1 Open the directory display containing the application directory

To use an application that is on a floppy disc, put the disc in the floppy drive and click on the floppy disc drive icon. This will open a directory display for the disc.

To use one of the computer's own applications, like *Edit*, click *Select* over the *Apps* icon on the icon bar to show the *Apps* directory display.

Try this *now as an example*.

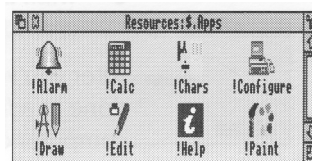

2 Start the application

Double-click on the application's icon. It will appear on the icon bar, ready for you to use.

For example, double click on !Edit. Its icon will appear on the icon bar, indicating that it has been loaded into the computer's memory, and is waiting for you to use it.



Some applications open their own windows as soon as you double click on their icon.

Using applications

Once you have started an application, you can usually begin using it by clicking on its icon on the icon bar. An application window will open on the desktop.

To use Edit, click on its icon on the icon bar: an empty Edit window will appear, ready for you to start writing.

Type in some text. Any text you type using the keyboard appears in the window. Text appears to the left of the vertical bar — the caret. The caret moves to the right, to make room for the text.

Press the Return key to start a new line, and press it again to leave a blank line.

Once you have typed a few lines of text, move the caret around the text by moving the pointer with the mouse and clicking Select — the caret will jump to the position of the pointer. You can insert (or delete) text at the new position.

If you aren't sure what the different keys on the keyboard are for, refer to Using the keyboard on page 37. A couple of points to note:

- The CapsLock key light may be on when you start, indicating that all letters you type will be capitals. Press this to get all lower-case letters.
- When the CapsLock is off, hold down the Shift key to type an upper-case letter (or one of the upper characters on the number keys).

After you've finished using an application, you will need to save any work you've done in a file on a disc (otherwise your work will be lost when you switch the computer off). The next chapter, Files and directories, tells you how to save the Edit file you've just created, so you can leave its window on the screen for now.

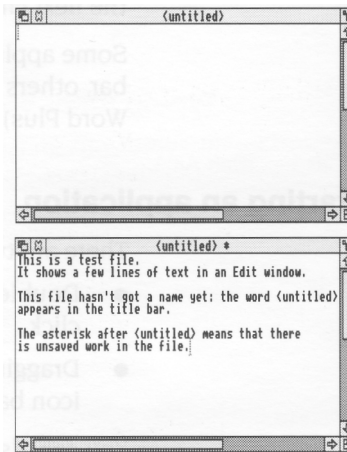

Using more than one application window

Often you'll have more than one application window open on the desktop (this is the power of RISC OS — it lets you transfer data between different windows and applications). You can only enter information (e.g. write some text, or draw a picture) in one window at a time. To change the window you are working in, move the pointer over your chosen window and click Select. You'll notice that the title bar and other window icons will change to a lighter shade, indicating that the input *focus* is now in that window.

For example, click on Edit's icon on the icon bar to bring up a second Edit window. The input focus will be in the second window.

Now move the pointer over the first Edit window and click Select to change the input focus.

Close the second window. You don't need it now.

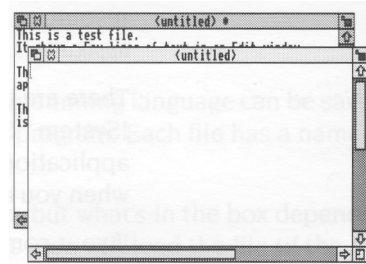

Quitting applications

When you've finished using an application, you will usually want to *quit* it. To quit an application:

1 Display the application's icon bar menu

Click Menu over the application's icon on the icon bar.

For example, try this on Edit's icon.

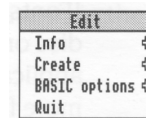

2 Choose Quit

Move the pointer to highlight the **Quit** option, then click Select.

If you've saved everything you've done in the application, its icon will disappear from the icon bar.

If you've forgotten to save any work, the computer will remind you, and ask if you really want to quit, discarding any changes.

*In this case, you have not yet saved your work in Edit. So, click on **Cancel** to leave Edit running. You'll find out how to save your work in the next chapter.*

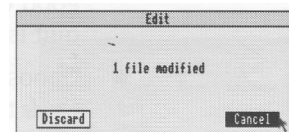

Getting the most out of applications

These are some tips to help you use applications efficiently. They're not essential reading now, and indeed they'll mean more to you after you've read the next chapter, so by all means come back to them later.

System applications

If you were writing a letter by hand, you would need to know where to find the *resources* to write it (paper, envelope, pen etc). The computer uses different types of resources, and also needs to know where to find them. They are contained in system *applications*.

There are three system applications the computer needs to be able to find: !System, !Scrap and !Fonts. If your computer has a hard disc, these system applications are already in the *root directory* (\$), and the computer will see them when you access the hard disc.

If your computer doesn't have a hard disc:



- Copy !System from the Applications disc onto a separate system disc (call it something like `SystemDisc`). Load this system disc first (and display its directory display) each time you switch the computer on.
- Copy !Scrap onto each new floppy disc you use (after you've formatted the disc!). This will save you having to swap discs too often.
- There are some *fonts* already in the computer's memory, and some extra ones in !Fonts. If you want to use these extra fonts, copy !Fonts from the Applications disc onto a disc of its own. Bring up its directory display before you start any applications that use fonts (like a desktop publishing package). If you buy any more fonts from your supplier, keep copies of them on this disc.

The chapter entitled *System applications* in the RISC OS 3 User *Guide* tells you more.

Memory

Appendix B: Getting the best out of 1MB computers in the RISC OS 3 User *Guide* gives you some hints on how to get the most out of the memory available on your machine (they are valid even if you have more than 1 MB). For instance:

- Always quit applications if you're not using them — they take up memory. A good way to make sure there is no memory 'tied up' by an application you've quit is to restart the computer — see *Switching off the computer* on page 61 .
- Choose a screen mode that doesn't use much memory. The RISC OS 3 User *Guide* tells you how much memory each screen mode uses. *MonitorType and screen modes* on page 75 tells you which screen modes you can use with your monitor.

Files and directories

This chapter explains how you can store information in an organised way, copy it, and delete it when you no longer need it.

Files and directories

Everything you create using an application or programming language can be saved as a file, whether it consists of text, graphics or a program. Each file has a name –you have to provide one when you save a new file.



File icons usually have a square box around them, but what's in the box depends on what sort of file it is. Double-clicking on a file's icon will load the file (if the application to display it is available).



Files are stored in *directories*. A directory can contain many files, and also other directories (*subdirectories*) and applications. Directory icons usually look like folders, to indicate that they can contain files or other directories.



There is a special sort of directory called an *application directory*. Its name always begins with a '!', and it contains an application program, such as a word-processor, or a drawing package. There is more about applications in the previous chapter and in the RISC OS 3 *Applications Guide*.

Opening directory displays

1 Open a directory display

For example, open the App2 directory. If you don't have a hard disc, you'll find this on the Applications disc.

The resulting directory display shows various icons, including a directory called Tunes.

2 Open a subdirectory

Double-click on Tunes, and the Tunes directory display will appear. This contains files, which are some different tunes you can play using the Maestro application.

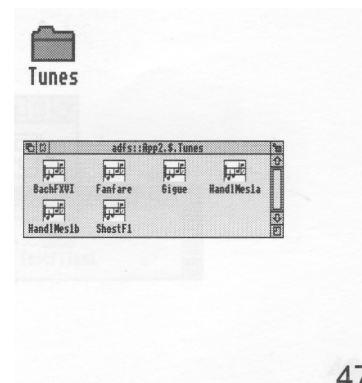

Double-clicking on an **application** directory loads the application, usually onto the icon bar ready for use. See the previous chapter for more on this.

Three refinements you might find useful later on:

- Double-clicking Adjust on a sub-directory icon opens the sub-directory display and simultaneously closes the directory display it came from (the *parent*). This reduces the number of windows on the desktop.
- Similarly, double-clicking Adjust on an application icon will simultaneously load the application and close its directory display.
- Clicking Adjust on the close icon closes a directory display and simultaneously opens its parent directory.

Building a file structure

You need to organise your files carefully. If you leave them all in the main directory on the disc, it will soon become large and unwieldy. There is also a limit to the number of files and directories you can have in an ADFS directory – 77.

Build up a file structure with files of similar types grouped in directories. For instance, the file structure of a disc for a newsletter might look something like this:

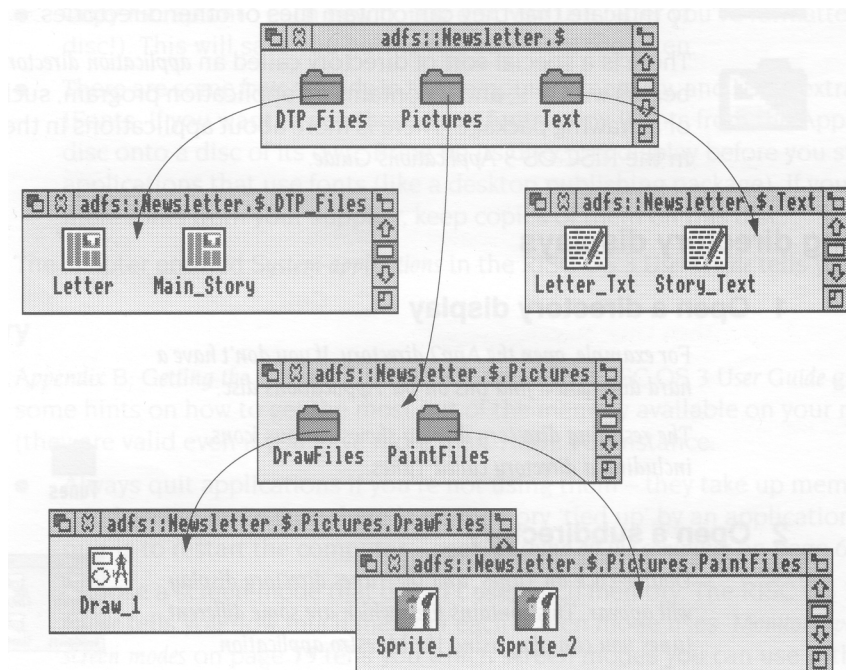

To create a structure like this, you will need to save files, create directories and copy files into them. These procedures are described on the following pages.

To practise saving files, you'll need a work disc of your own. Create one by taking a new disc and formatting it, as described in *Formatting a floppy disc* on page 32. Give it the name `WorkDisc`. Make sure the disc isn't write-protected, or you won't be able to save files on it.

A fuller description of the *filing system* is given in the RISC OS 3 User Guide, in the chapter entitled *Discs, networks and filing systems*.

Creating a new directory

1 Open a directory display

Decide where you want to create the new directory, and open a directory display.

For example, put your work disc in the floppy disc drive and click on the floppy disc icon on the icon bar.

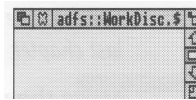

2 Display the Filer menu

Click Menu (middle) button with the pointer somewhere over the directory display, and the Filer menu will appear.

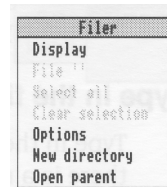

3 Select New directory

Highlight the **New directory** option, and move the pointer over the arrow to the right of the option. A writable menu box will appear.

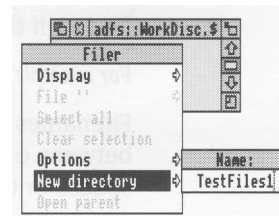

4 Type in the directory name

Type in the name you want to give the new directory.

Call it `TestFiles1`, for example.

5 Click on the new directory name

Click on the new name (or press the Return key) to create the directory.

An icon for the new directory will appear in the directory display.



Saving (and loading) a file

1 Open the directory display

Decide which directory you want to save your file in, and double-click on its icon to open a display for it.

For example, do this on the TestFiles1 directory you've just created.

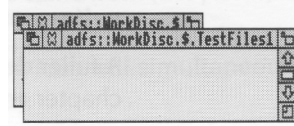

2 Select Save

Move the pointer over the work you want to save and press the Menu (middle) button to display the menu for the application.

For example, try this on the Edit file you created in the last chapter.

Move the pointer across the arrow to the right of the word **Save**: a dialogue box appears, containing a writable box for you to type in the file name you want.

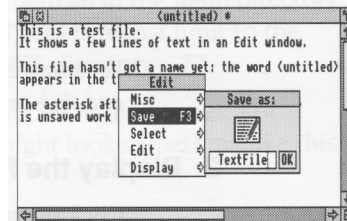

3 Type in the file name

Type in the name you want to give to the file. If there is a name already in the box (like TextFile here) which you don't want, erase it first with the Delete key (or Ctrl U).

For example, call your Edit file EditTest.

Filenames and directory names can have between one and ten characters, but **not** blank spaces or the characters \$ & % @ \ ^ : . # * " |

You can use upper-case (capitals) and lower-case letters wherever you like in the name – the computer makes no distinction between them. The only reason for calling your file EditTest instead of edittest is that it's easier for you to read.

If you have saved this file before (the correct file name will appear on the box if you have) you can miss out the next step – just press Return.

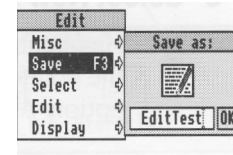

4 Drag the file icon into the directory window

Select the file icon in the dialogue box, drag it into the directory window, and release the button.

For example, drag it to your TestFiles1 directory.

You can **load** the file again by double-clicking on its icon (as long as the relevant application is in the Apps directory, or its icon has been displayed on the screen since you last switched off the computer.

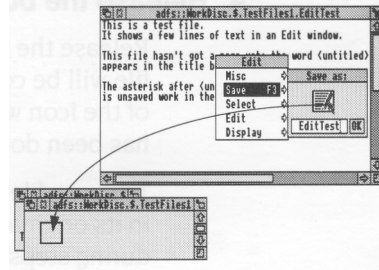

Copying (and moving) a file to another directory

1 Open the destination directory display

Double-click on the icon for the directory you want to hold the copy. Its directory display will be opened.

For example, create another new directory, on your disc WorkDisc, called TestFiles2 (follow the instructions in Creating a new directory on page 49). Open the new directory, so both TestFiles1 and TestFiles2 are displayed.

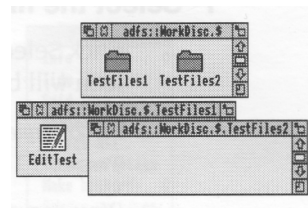

2 Select the file to be copied

Point at the icon of the file to be copied, and press the Select (lefthand) button to highlight it. Keep the button pressed down.

(You can select more than one icon by clicking on them with Adjust (or by choosing **Select all** from the menu). Use Adjust to deselect icons, too.)

3 Drag the icon to the new directory

Drag the file icon into the new directory window.

For example, drag the file EditTest onto the directory TestFiles2.

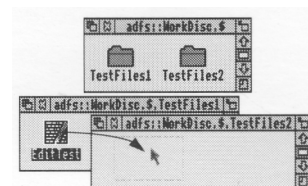

4 Release the button

Release the Select (or Adjust) button and the file will be copied into the new window. A copy of the icon will appear in the window when this has been done.

To *move* a file (so that the original is not retained in its original location), hold down the Shift key during steps 2 and 3.

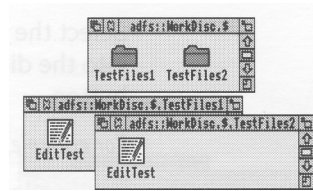

Deleting files and directories

Warning: once you have deleted a file or directory, you can't get it back again, so use this option with caution!

1 Select the file or directory to be deleted

Click Select on the icon you want to delete. The icon will be highlighted.

For example, select the copy of EditTest in directory TestFiles2.

(You can select more than one icon by clicking on them with Adjust, or by choosing **Select all** from the Filer menu.)

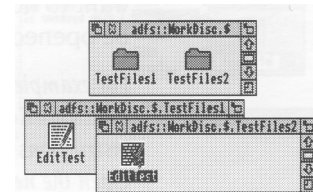

2 Display the File (or Directory) submenu in the Filer menu

Click Menu to display the Filer menu, and point to the **File** option (this might be **App.**, **Dir.** or **Selection** instead of **File**, depending on what you've selected).

Move the pointer to the arrow on the **File** option. A submenu of options will be displayed, including **Delete**.

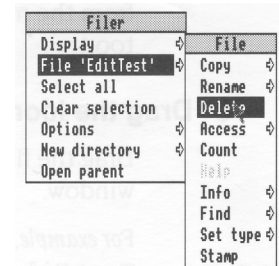

3 Delete the file or directory

Click on **Delete**. Your selection will be deleted from the directory.

Do this with the copy of file `EditTest` in directory `TestFiles2`.

Note: deleting a directory also deletes all the files in that directory, so use this option with caution!

If any files (or directories) have been *locked* against deletion, they will not, in fact, be deleted. See the *RISC OS 3 User Guide* for information on *file access* and removing *file locks*.

Pinboard

If you click Menu over a blank area of the desktop, you will see a menu called **Pinboard**.

Don't worry too much about this at the moment. It's explained in the *RISC OS 3 User Guide*, and enables you to do things like

- changing the whole background of the desktop into a picture
- leaving file or application icons 'stuck' to the desktop background, so you can see and use them, even when the directory they came from is closed
- closing a window down to an icon on the background.

You might come across one use of Pinboard when you are dragging files (for example) from one directory to another. If you let go of the Select button accidentally while the file you are dragging is over a blank portion of the desktop, its icon will stay on the background.

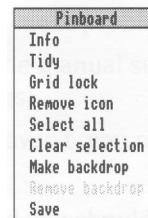

You can remove the 'dropped' icon from the background as follows:

1 Display the Pinboard menu

Move the pointer over the dropped icon and click Menu.

2 Remove the icon

Choose **Remove icon** from the menu. If that option is greyed out, it means that the pointer wasn't quite over the icon when you clicked Menu. Try again.

This action does **not** delete the file itself — the icon stuck on the pinboard is merely a 'pointer' to the real file on your disc.



Printing

This chapter gives you an introduction to printing a file from your computer. It uses an Acorn JP-150 printer as an example.

Once you've used an application to produce some work, you'll probably want to print out what you've done. This chapter takes you through each stage involved in printing a file, from setting up the computer to producing a printed page.

This chapter assumes that you have already



- connected your printer to the computer (using the parallel port, in the case of the Acorn JP-150) using the correct cable (see *Setting up the computer* on page 3 and *Appendix C: Attaching peripheral devices* on page 77)

Note: Printer cables longer than about 5m can cause problems.

- set any options on the printer itself (check in the manual supplied with the printer whether you need to change any settings)
- switched the printer and computer on. If you haven't, you can find out how to do this in *Switching on* on page 7.

Follow the instructions in this chapter carefully, and you shouldn't have any trouble printing your work. If you do get into difficulties, see *Problems with printing* on page 60 or check with your supplier.

Setting up

Before you can print anything, you need to make sure that the computer knows what sort of printer it is connected to. These are the steps involved:



- Loading the *printer manager, !Printers*. This is an application which controls the printing process.
- Loading a suitable *printer driver*. This is a program which tells the computer what type of printer you're using.
- Setting the correct *Configure and Connection* options using the printer manager.
- Activating the printer (though this is not always necessary).
- Saving the printer options.

The following pages take you through this setting up process in detail.

1 Make a copy of !Printers

Open the App1 directory display. Copy !Printers to your root directory (if you have a hard disc) or your system disc. Use the copy, not the original so that you always have an unchanged version you can fall back on.

2 Load !Printers

Load !Printers by double-clicking on its icon. After a few seconds its icon will appear on the lefthand side of the icon bar, ready to use.

Click Menu on the icon and choose **Printer control....** This will display the Printer control window. You'll use this in the next step.

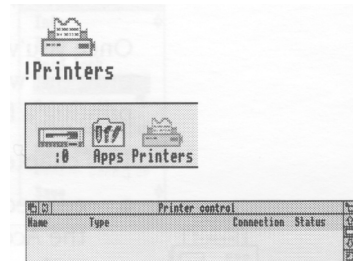

3 Load a printer driver

Double-click on the directory called Printers in the App2 directory display. Double-click on the subdirectory which corresponds to the make of your printer (*in this case, Acorn*).

You'll then see a directory display containing all the available printer drivers. Decide which printer driver suits your printer, and load it by dragging its icon into the Printer control window. (If you can't see a printer driver that matches your printer, see *Problems with printing* on page 60).

In this case, load the driver called JP-150, which is specifically for the Acorn JP-150 printer.

The Printer control window will change to include details of the printer driver you've just loaded, and so will the icon on the icon bar.

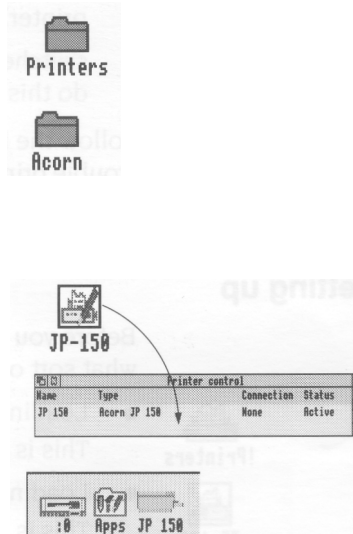

4 Set the Configure options

Click Select on the printer's name in the Printer control window (this will highlight it) then click Menu. This will display the Printers menu.

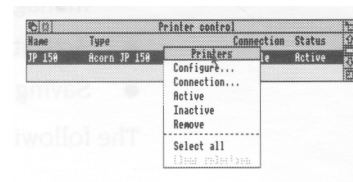

Choose **Configure...** to display the configuration window. Change any settings that aren't correct (refer to the manual supplied with your printer).

*The only options you'll need to worry about for now in this window are **Resolution, Paper feed..** and **Quality.***

*For example, you can set **Paper feed...** to **Manual** or **Auto**. If you need to change it, click on the arrow to the right of the box and choose from the **Paper feed** menu that appears (the manual for your printer will tell you which type it uses.) Experiment with the other options when you want a better quality print of your work.*

When the settings are correct, click on **OK**.

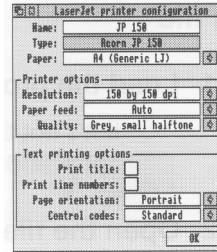

5 Set the Connection options

Click Menu on the printer name in the Printer control window to display the Printers menu again. This time choose **Connection....** You'll see the Connections window displayed.

Click on the button to the left of the connection that your printer uses.

*In the case of the JP-150 choose **Parallel**.*

Click on **OK**. The details in the Printer control window will change to reflect your choice.

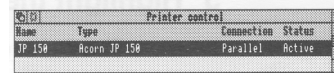
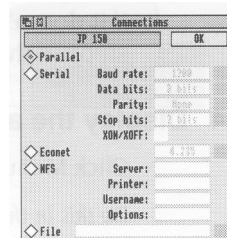

6 Activate the printer (if necessary)

Choose **Active** from the Printers menu (you'll only need to do this if you drag **more** than one printer driver onto the Printer control window — the first printer is set to active by default).

7 Save the settings

It's a good idea to save the settings you've just made. See *Saving printer configuration settings* on page 59.

Printing a file

1 Load the program

If it's not there already, load the program or application you used to create the file.

2 Open the file you want to print

Double-click on a file to open it.

For example, open the TestFiles1 directory on your workdisc, that you created in the previous chapter. Double-click on the icon for the file EditTest.



3 Press the Print key on the keyboard

Your file should now print out. It may take some time.

If it doesn't print out, follow the rest of the steps in this section.

4 Display the application menu

Click Menu inside the file's window.

Do this in the window for EditTest.



5 Highlight the Print option

The **Print** option is not always in the top-level menu of an application. You may have to search through the submenus to find it.

*To get to the **Print** option in Edit, move the pointer to the right of the **Misc** option, onto the **Print** option.*



6 Print the file

*In this case, click on **Print**.*

Your file should print out. It may take some time, but if things don't appear to be working, try some of the hints at the end of this chapter.

Another way of printing

You can often print a file by dragging its icon and dropping it on the printer icon bar icon.

1 Follow step 1 from the previous section

For example, load Edit.

2 Open the directory containing the file's icon

For example, open the TestFiles1 directory on your workdisc, that you created in the previous chapter.

You will see an icon for the file EditTest. You don't need to double-click on it.

3 Print the file

Drag the file's icon over the printer icon on the icon bar and release the mouse button. Your file will print out.

Try this with the file EditTest.

Not all applications allow you to print this way, however. Check either in the RISC OS 3 *Applications Guide*, or the manual supplied with the application.

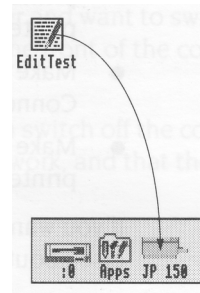
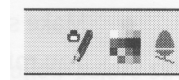

Saving printer configuration settings

It's worth saving the printer configuration so that you don't have to set it up every time you switch on the computer.

Click Menu over the printer icon on the icon bar and choose **Save choices**. Next time you load ! Printers it will automatically start up with this saved configuration.

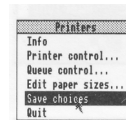

Problems with printing

The most common problems with printing occur in the setup stage. If your computer thinks it is connected to the wrong printer, you will have trouble. Take care with the following when you set up:

- Make sure that you're using the correct cable, and that it's not too long. You might get problems if the cable is longer than about 5m. This can sometimes cause spurious characters to be printed.
- Make sure you use the correct printer driver.

If there isn't one that matches your printer, you'll probably still be able to print – most printers have an Epson- or IBM-compatible mode. Check in the printer's manual if this is the case, and then choose one of the Epson or IBM printer drivers.

- Make sure that you have set the options correctly in the **Printers** menu and the Connections and Configuration windows.
- Make sure the printer is on line (not all printers have this option - check in your printer's manual) and hasn't run out of paper.

If you want to know what all the options in the **Printers** menu are for, or anything else about printing, see the chapter entitled *Printing* in the *RISC OS 3 User Guide*.

Switching off the computer

This chapter describes the correct procedure to follow before switching off your computer.

Normal shutdown procedure

When you've been doing some work on the computer and want to switch it off, you **can** simply switch off using the ON/OFF switch on the front of the computer. **However**, you'll lose any unsaved work this way.

By following the instructions in this chapter, you can switch off the computer more 'gracefully'. This will ensure that you don't lose any work, and that the computer is in a safe state before you turn off at the switch.

1 Save your work

Make sure that you save any work you have been doing, or you might lose it (see *Files and directories* on page 47).

2 Shut the computer down

Move the pointer over the Task manager icon (the Acorn) and click *Menu*.

Choose **Shutdown** from the menu.

The computer checks to see whether you have left any work unsaved. If you have, a window will appear, asking you if you really want to quit the relevant application.

If you're sure you want to quit, click on **Discard** (to discard any changes). If you want to save your work before you switch off, click on **Cancel**, save the work, then choose **Shutdown** again.

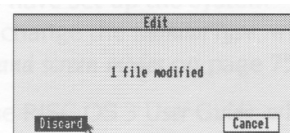

The computer will perform any 'tidying-up' operations necessary, such as quitting any applications, logging off any networks to which you may be connected, and parking the hard disc drive heads.

A window will appear when all this has happened, telling you that the computer is ready to be switched off.

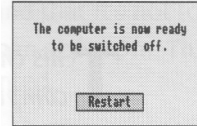

3 Switch off the computer and peripherals

Remove any floppy discs from the disc drive. Switch off the computer at the ON/OFF switch on the front.

Switch the monitor off (unless it was plugged into the power outlet on the back of the computer and switched off with the computer). If you have any other peripherals connected to your computer, check in the manuals supplied with them to see whether you need to switch them off every time you switch off the computer.

Note: When the window appears telling you shutdown has completed, you can restart the computer instead of switching off.

Click on **Restart** to do this, or hold down the Ctrl key and press the Break key or the Reset button.



If things go wrong

This chapter offers solutions to some problems you might encounter while you are getting started with your computer. If none of these help, consult your supplier.

No picture

Check that

- the screen has not simply blanked as a result of the **Blank delay** set in !Configure (if this is the case, moving the mouse or pressing the space bar will restore the display)
- the power supplies to computer and monitor are connected
- the monitor is connected to the computer, using the correct cable, the right way round
- the computer is turned on
- the monitor is turned on
- the brightness control on the monitor is not turned down.

Flickering or flashing display

Check that the connectors between the monitor and the computer are tight. Switch off both the computer and the monitor, and push in the connectors firmly. Tighten the screws of the connector to the computer back panel with a small flat-bladed screwdriver.

Different screen display

If the computer starts up with a different display, or other unexpected things occur while you are using it, you (or someone else) may have set up the system configuration in a different way. You may need to change the *MonitorType*, which is set to **Auto** by default. To do this, see *MonitorType and screen modes* on page 75.

See the chapter entitled *Resetting and power-on* in the RISC OS 3 User Guide, which tells you how to restore your computer to its default (factory) configuration.

Flashing floppy drive light

If the floppy drive indicator light flashes more than once when you switch on, and the computer doesn't power up properly (you can't see the RISC OS desktop after a few seconds) consult your supplier.

If the LED only flashes once, this is normal. It should happen every time you switch on or reset the computer.

Pointer won't move

If moving the mouse does not move the pointer, check the following:

- The mouse is firmly connected to the keyboard and that the keyboard is firmly connected to the computer.
- The surface you are using the mouse on is firm enough to allow the mouse ball to move. Move the ball with your fingers to check that the mouse works.

You might need to clean the mouse ball. See *Cleaning the mouse* on page 67.

If all this fails, try holding down Ctrl and pressing the RESET button to start the computer up again.

The pointer is not visible on the RISC OS desktop

If the pointer is not visible at all, check whether the command line (with ** prompt*) is at the bottom of the screen (you might have accidentally pressed F12):

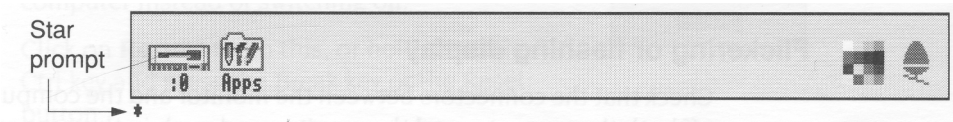

If it is, press Return to get back to the Desktop.

If the computer powers up in Supervisor mode

If the computer powers up in Supervisor mode (the word **SUPERVISOR* will appear at the top of a black screen) type Desktop at the prompt, then press Return. If this happens every time you switch your machine on, ask your supplier for help.

The computer 'forgets' its configuration

If the computer frequently forgets its configuration settings, or the clock consistently loses time, it may be that you haven't used the computer for a long time and the computer's internal CMOS RAM support battery may need recharging. Leave the computer switched on for a couple of hours, then try again.

If this doesn't cure the problem, the computer's internal CMOS RAM support battery may be faulty. Take the computer to your Acorn supplier, who will investigate.

The self-test does not complete properly

If you do not see a message *similar* to the following when the self-test is performed:

```
RISC OS 4096k  
Acorn ADFS
```

or if the self-test does not complete properly (the screen may stay red after you switch on, and the floppy drive indicator light may flash on and off a few times) then contact your supplier. There may be a fault with the computer's hardware.

Note: The number in the above message (4096) indicates memory size and may differ according to your model of computer.

There are unexpected icons on the otherwise empty desktop

You might have dragged a file or application towards the icon bar, but accidentally let go too soon. See *Pinboard* on page 53.

Appendix A: Maintaining your computer

This chapter tells you more about looking after your computer. It describes how to clean the computer and the mouse.

Cleaning the computer, monitor and keyboard

First, remember to follow the *Guidelines for safe operation* at the very beginning of this guide. In particular, switch off and unplug the computer and any peripherals.

You can clean the computer case by wiping it gently with a soft, slightly damp cloth. Clean the keyboard with a clean, dry paintbrush. For advice on cleaning the monitor, refer to the manual accompanying it.

Cleaning the mouse

You should use the mouse on a surface that is as clean and as dust-free as possible. However, dust does sometimes get caught up in the ball on the underside of the mouse.

Clean the mouse occasionally to keep it running smoothly. To clean the mouse, you need the following items:

- some tape head cleaner
- a cotton swab
- a lint-free, dry cloth.

To remove the ball and clean the mouse, take the following steps

- 1 Unplug the mouse and turn it upside down.
- 2 Unlock the ball retainer by twisting it in the direction of the arrows by a quarter of a turn (see the diagram overleaf).
- 3 Hold one hand over the ball and retainer and turn the mouse right side up, allowing the ball and retainer to drop into your hand. Set them aside in a safe place.
- 4 Locate the three plastic rollers as shown in the drawing overleaf.
- 5 Lightly moisten the cotton swab with tape head cleaner and apply it gently to the rollers. Rotate the rollers, carefully cleaning off any dust or dirt that may be clinging to them.

- 6 Make sure the inside of the mouse is free from dust.

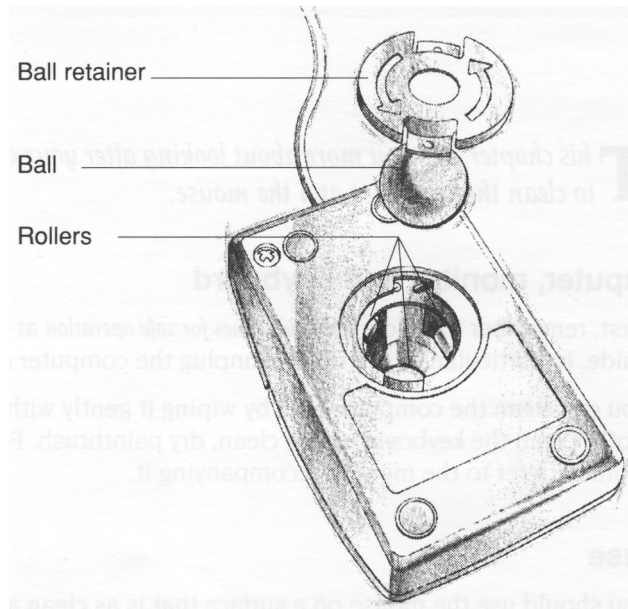

- 7 Wipe the ball with the clean, dry cloth. Do not use a cloth which may leave lint, and do not use cleaning liquid on the ball.



To replace the ball and retainer, take the following steps:

- 1 Turn the mouse upside down and place the ball back in the case.
- 2 Return the retainer to its original position (lock it in place by twisting it clockwise by a quarter of a turn).

Appendix B: Monitor connections

This appendix tells you how to connect different types of monitor to your computer.

Your computer has been designed so that you can use it with a wide variety of monitors. In most cases the monitor can be directly connected to the computer using the cable (or cable and adaptor) supplied with the monitor.

If you use the correct cable, the computer can sense what type of monitor you have connected. There may be one or two exceptions to this, but you should always get some sort of picture to start with.

What's involved

Take the following steps to get a picture on your monitor:

- 1 Use *Table 1: Monitor information* on page 70 and *Cables and adaptors* on page 71 to check
 - whether your monitor was supplied with the correct cable (if it wasn't, refer back to your supplier)
 - whether your monitor needs an adaptor, and the right one was supplied
 - the *MonitorType* best suited to your monitor.
- 2 If your monitor needs an adaptor that isn't supplied, make one (or ask your supplier to make one for you) using the information in *Cables and adaptors*.
- 3 Connect the monitor to your computer, using the cable information gained from steps 1 and 2.
- 4 Follow the instructions in *Switching on* on page 7 to get a picture on your monitor.
- 5 If necessary, change the *MonitorType* to the number shown in *Table 1: Monitor information* (see *MonitorType and screen modes* on page 75 for instructions).

Note: Various third party monitors and other peripheral equipment are described in this Guide. The description of these or any other third party equipment does not imply any recommendation or endorsement by Acorn Computers Limited, and users must satisfy themselves as to the suitability of any peripheral equipment (including monitors) on advice from the equipment supplier.

Table 1: Monitor information

Monitor family	Examples	Adaptor req'd
VGA [†] , SVGA [†] or Multiscan with 15-way connector	Acorn AFK18 NEC Multisync 3D NEC Multisync II Taxan 795 Philips 3CM 3209 Panasonic TX-14H8BT	None* None* (supplied) None* None* None*
Multiscan with 9-way connector (separate syncs)	Eizo Flexscan 9060	B
Multiscan with 9-way connector (composite syncs)	Taxan 770	C
TV standard with 9-way connector	Acorn AKF17	D
SCART TV or monitor with SCART connector	Acorn AKF12	E
Standard resolution mono	Philips BM7502 Philips BM 7442	F

+To allow only the VGA or VGA/SVGA modes to be selected, set *MonitorType* to 3 or 4 respectively (see *MonitorType and screen modes* on page 75) otherwise all the *MonitorType* 1 modes will be made available.

*No adaptor required. See *Cable type A* on page 71 for a typical pinout.

Cables and adaptors

This section gives you the pinouts on standard cables supplied with monitors, and tells you how to make adaptors if they are required.

The pinout of the video connector on the back of the computer is illustrated in *Appendix D: Hardware components and connectors*.

Cable type A

This cable is supplied with most VGA, Super VGA and Multiscan monitors and is terminated at the computer end with a 15-way VGA style D-type plug.

The table below shows the typical pinout for the computer end of this type of cable. You can use this cable without modification.

Pin	VGA and Multiscan	Multiscan
1	Red	Red
2	Green	Green
3	Blue	Blue
4	Not Connected	0V (See note 1)
5	0V (or test)	0V (or test)
6	Red Rtn (0V)	Red Rtn (0V)
7	Green Rtn (0V)	Green Rtn (0V)
8	Blue Rtn (0V)	Blue Rtn (0V)
9	Not Connected	Not Connected
10	0V	0V
11	0V (See note 1)	0V (See note 1)
12	Not Connected	Not Connected
13	HSync	HSync
14	VSync	VSync
15	Not Connected	Not Connected

Note 1: Normally linked to pin 10 (0V) in the cable or in the monitor.

Note 2: A NEC Multisync II monitor comes supplied with a 9-way connector on the computer end of the cable, and an adaptor which allows you to connect this to the 15-way connector on the computer.

Multiscan monitors that have a 15-way connector are usually wired with the ID bits indicating either a VGA or SVGA monitor. In this case the system software will display a VGA mode 27.

Adaptor type B

The cable supplied with some Multiscan monitors is terminated at the computer end with a 9-way D-type plug. You need a standard 15-way plug to 9-way socket adaptor:

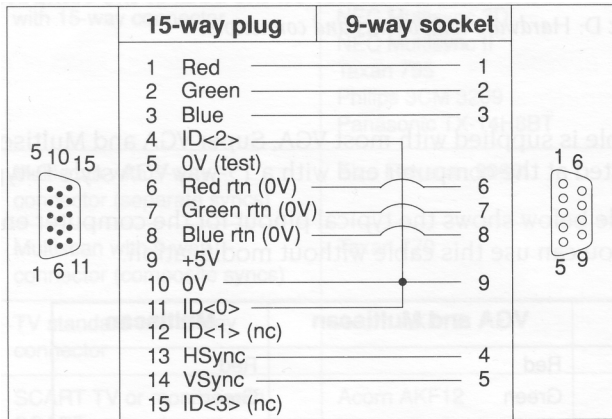

Most Multiscan monitors are now being designed to be VGA-compatible and will work satisfactorily when driven with separate horizontal and vertical sync signals.

Adaptor type C

The cable supplied with some Multiscan monitors requiring composite sync is terminated at the computer end with a 9 pin D-type plug. In this case you need a 15-way plug to 9-way socket adaptor:

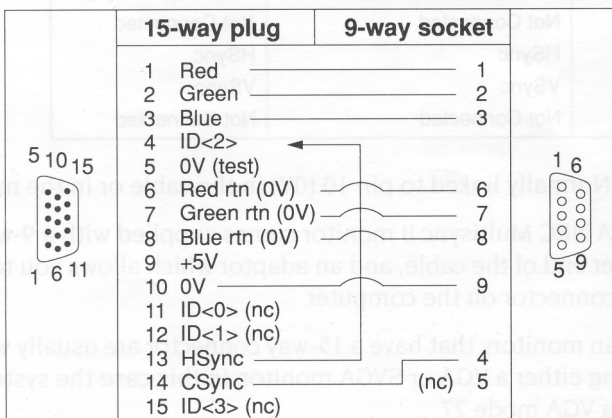

Note: HSync (pin 13) linked back into ID<2> (pin 4) tells the computer that composite (rather than separate) sync is required, and that modes compatible with a Multiscan monitor can be displayed.

Adaptor type D

The cable supplied with some TV-type monitors is terminated at the computer end with a 9 pin D-type plug. You need a 15-way plug to 9-way socket adaptor:

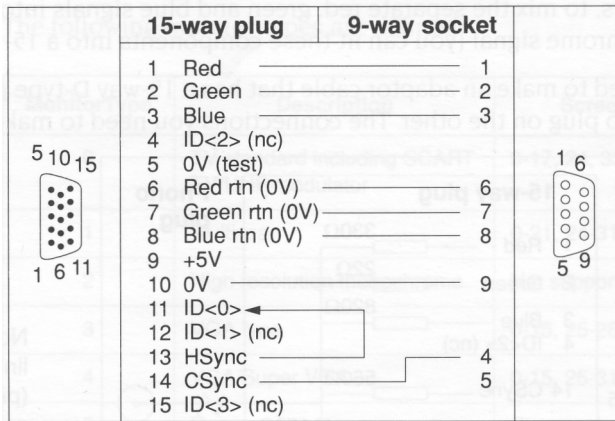

Note: HSync (pin 13) linked back into ID<0> (pin 11) tells the computer that composite (rather than separate) sync is required, and that only modes compatible with a TV standard monitor can be displayed.

Cable type E

You need to make this cable (if it's not supplied) for use with televisions and monitors using a SCART input socket:

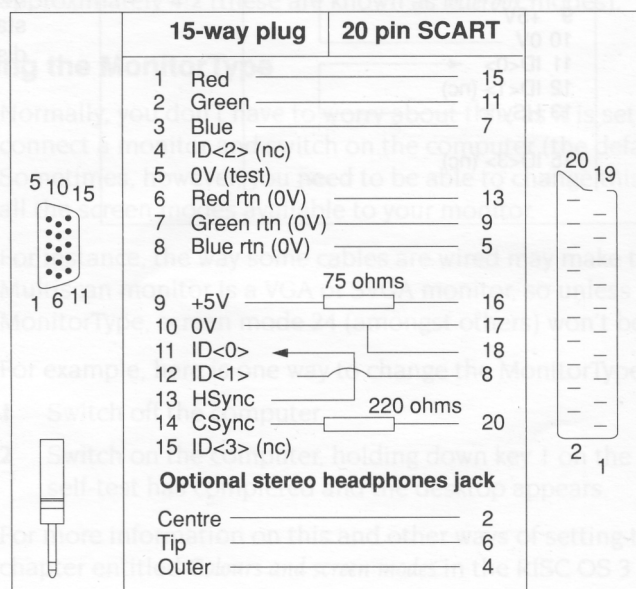

Note 1: HSync (pin 13) linked back to ID<0> (pin 11) tells the computer that composite (rather than vertical) sync is required, and that only modes compatible with a TV standard monitor can be displayed.

Note 2: On some TVs you might have to manually switch the TV into SCART mode (check how to do this in the TV's manual).

Cable type F

You need to make this cable to use with monochrome monitors which have a phono input socket. You need a 15-way plug to phono socket adaptor with resistors, to mix the separate red, green and blue signals into a composite monochrome signal (you can fit these components into a 15-way connector shell).

You need to make an adaptor cable that has a 15-way D-type plug on one end, and a phono plug on the other. The connections you need to make are as follows:

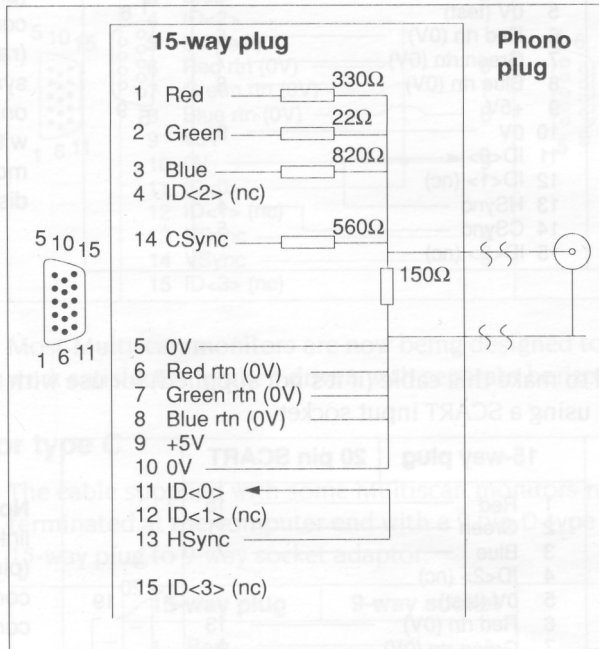

Note: HSync (pin 13) linked back into ID<0> (pin 11) tells the computer that Composite sync (CSync) is required rather than VSync on pin 14 and that only modes compatible with a TV standard monitor can be displayed.

MonitorType and screen modes

MonitorType is a computer variable that controls which screen modes (described in the RISC OS 3 *User Guide*) your computer can display.

The following monitor types are defined:

MonitorType	Description	Screen modes available
0	TV standard including SCART TV/UHF modulator	0-17, 24, 33-36
1	Multiscan	0-21, 24-31, 33-46
2	High resolution monochrome	Not supported
3	VGA type	0-15, 25-28, 41-46
4	VGA/Super VGA	0-15, 25-31, 41-46
5	Reserved	Reserved
Auto	Auto configure (default)	Monitor-dependant

Note: For screen modes 0-15 on MonitorType 3, 4 and 5 the aspect ratio is approximately 4:2 (these are known as *letterbox* modes).

Changing the MonitorType

Normally, you don't have to worry about this, as it is set automatically when you connect a monitor and switch on the computer (the default **Auto** setting). Sometimes, however, you need to be able to change this variable, to make use of all the screen modes available to your monitor.

For instance, the way some cables are wired may make the computer think that a Multiscan monitor is a VGA or SVGA monitor, so unless you change the MonitorType, screen mode 24 (amongst others) won't be available.

For example, here is one way to change the MonitorType variable to 1:

- 1 Switch off the computer.
- 2 Switch on the computer, holding down key 1 on the numeric keypad until the self-test has completed and the desktop appears.

For more information on this and other ways of setting the MonitorType, see the chapter entitled *Colours and screen modes* in the RISC OS 3 *User Guide*.

Changing the screen mode

To change the screen mode displayed on your monitor, proceed as follows:

- 1 Click Menu over the Palette icon.
- 2 Move the pointer to the right of the **Mode** menu option.
- 3 Click on one of the screen modes listed (or move the pointer to the bottom of the **Mode** box, type in your chosen mode number after the caret, then press Return).

You can configure your computer so that it always displays a particular screen mode using the !Configure application. See the *RISC OS 3 Applications Guide*.

Appendix C: Attaching peripheral devices

This appendix gives you advice on attaching different peripheral devices to your computer.

Introduction

There are a number of peripheral devices that you can attach to your computer to expand its capabilities – for example, printers and modems.

This chapter offers some general guidelines for connecting peripherals to your computer. Some examples are given for attaching specific peripheral devices, but often you'll need to use the general information provided to help you decide how to connect a device. For example, the signal connection diagrams that are given for each hardware connection act as guidelines which will work with most hardware. Some or all of the connections shown with dotted lines may be unnecessary, and you must first check the manual accompanying the peripheral device that you are connecting.

There are two ports available on your system that are used to attach peripheral devices: the Serial port and the Parallel port.

The characteristics of each of the above ports are described in the following sections along with information about the types of devices that can be connected to them.

Note: Various third party monitors and other peripheral equipment are depicted or described in this Guide. The illustration or description of these or any other third party equipment does not imply any recommendation or endorsement by Acorn Computers Limited, and users must satisfy themselves as to the suitability of any peripheral equipment (including monitors) on advice from the equipment supplier.

Serial port

The serial port is by far the most versatile and sometimes the most troublesome port to use. The port supports two different types of peripheral or equipment: Data Terminal Equipment (or DTE – for example printers and computers), and Data Circuit-terminating Equipment (or DCE – for example modems). It follows that you will need different cables, depending upon which type of peripheral (DTE or DCE) you are connecting to your machine. The computer itself is DTE.

When you connect peripherals to the serial port:

- Ensure that screened cabling is used to connect up the peripheral, and that the screening is connected to the shell of the connector.
- Consult the peripheral manufacturer's instructions for pin connections.

Printers on the serial port

Hardware connection

You should check carefully what options for flow control your printer uses, and if possible set it to XOFF/XON flow control. Some printers have alternative flow control mechanisms involving ETX/ACK (different control characters from XOFF/XON, transmitted under slightly different circumstances), or RTS/CTS (signals on additional wires on the interface cable).

An example

The diagram (right) shows the serial port signals used to connect to an Apple LaserWriter laser printer:

Software connection

For information on how to set up the software side of things, see *Prinfig* on page 55. You'll also find more information in Prinfig in the *RISC OS 3 User Guide*.

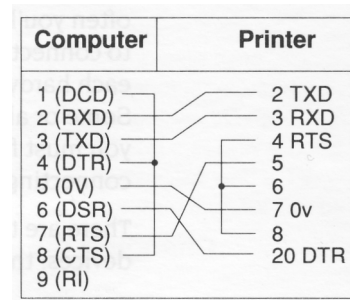

Modems on the serial port

A modem is usually connected up differently from a printer. This is because a modem is a DCE device, whereas printers are DTE devices. The main difference is that the connections are 'straight through', in that the modem expects to *receive* data on the 'transmitted data' line, and vice versa, whereas when connecting terminal to computer or computer to computer the connections have to be crossed over.

Hardware connection

You may need to make an adaptor cable to connect a modem or other standard RS232 DCE device. Here is the wiring guide for connecting to a standard RS232 25-way D-type connector:

In practice you may leave out RI and DSR as they are not often used. If the modem doesn't provide a CTS signal, leave out this wire and instead connect CTS to RTS at the computer end.

Computer	Modem
1 (DCD)	8 (DCD)
2 (RXD)	3 (RXD)
3 (TXD)	2 (TXD)
4 (DTR)	20 (DTR)
5 (0V)	7 (0V)
6 (DSR)	6 (DSR)
7 (RTS)	4 (RTS)
8 (CTS)	5 (CTS)
9 (RI)	22 (RI)

If you are connecting a different type of modem from the one illustrated, the differences will be in which signals the modem looks at and can supply. You can configure some modems to use or ignore the various control signals, by means of DIP switch settings or by sending commands.

Software connection

For information on how to set up the software, it's best if you check with your supplier, who will be able to tell you the communications package to use that best suits your modem.

Parallel port

The parallel port is commonly used to connect a printer, or to send/receive data to/from a device using eight data pins in parallel, making a byte of character data.

There is a diagram of the parallel port pinout in *Appendix D: Hardware components and connectors*.

Printers on the parallel port

Hardware connection

You need a 25-way D-type connector to connect a parallel printer to the computer. Often, the cable supplied with your printer will be suitable. If not, the table overleaf gives an example of how the pins on the computer's parallel port map onto a 36-way Centronics-type Delta 57 connector.

The mapping is not one to one. The signals you need will depend on the type of printer, and the settings of any switches on the printer. As a general guide, most printers will work without the signals marked Optional.

In the first instance, ask your supplier to make sure he gives you the correct cable. Check the printer's documentation for more information.

Computer	Printer
1 (STROBE*)	1
2 (DATA0)	2
3 (DATA1)	3
4 (DATA2)	4
5 (DATA3)	5
6 (DATA4)	6
7 (DATA5)	7
8 (DATA6)	8
9 (DATA7)	9
10 (ACK*)	10
11 (BUSY)	11
18 to 25	GND 19 to 30

Optional	
12 (PE)	12
13 (SLCT)	13
14 (AUTO FD XT*)	14
15 (ERROR*)	32
16 (INIT*)	31
17 (SLCT IN*)	36

Software connection

Printing on page 55 tells you how to configure your computer to use a Acorn JP- 150 printer. You'll find more information in *Printing* in the RISC OS 3 *User Guide* and the manual supplied with your printer.

Appendix D: Hardware components and connectors

This chapter describes the hardware components of the computer, and gives details about the connections of the different sockets.

The front of the computer

The drawing below shows the front of the computer.

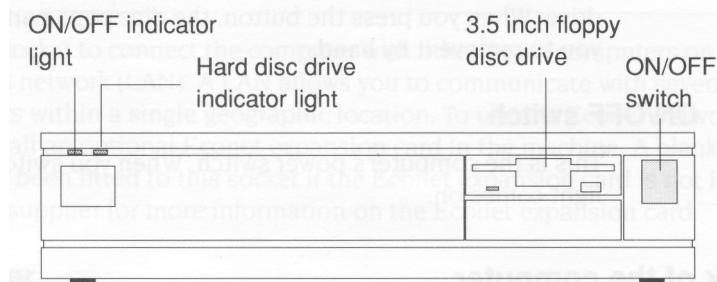

ON/OFF indicator light

This green light comes on when you turn the computer on.

Hard disc drive indicator light

Your computer will have this light whether or not it has a hard disc installed. The amber light only comes on when the hard disc drive is being accessed by the system. If your computer hasn't got a hard disc drive, you can obtain one from your supplier.

3.5 inch floppy disc drive

The floppy disc drive is located on the right. It includes a disc insertion slot, a drive indicator light, and a disc eject button. You can obtain a second floppy disc drive from your supplier.

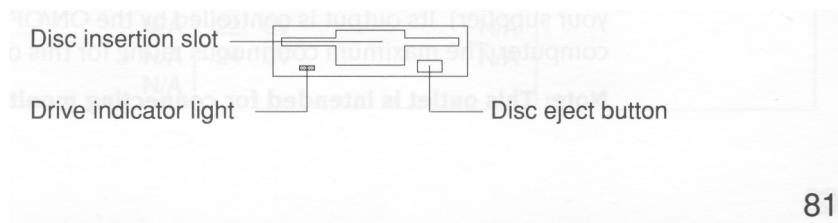

Disc insertion slot

This is where you insert floppy discs.

Drive indicator light

The indicator light comes on when the floppy disc drive is being accessed by the system.

WARNING: When the floppy disc drive indicator light is on, the computer is actually reading or writing data. Do not remove the floppy disc or turn off the computer while the light is on.

Disc eject button

The disc eject button releases the floppy disc so that you can remove it from the drive. When you press the button, the disc pops partially out of the slot, allowing you to remove it by hand.

ON/OFF switch

This is the computer's power switch. When you switch it on, the ON/OFF indicator light comes on.

The back of the computer

The drawing below shows a typical view of the back of the computer.

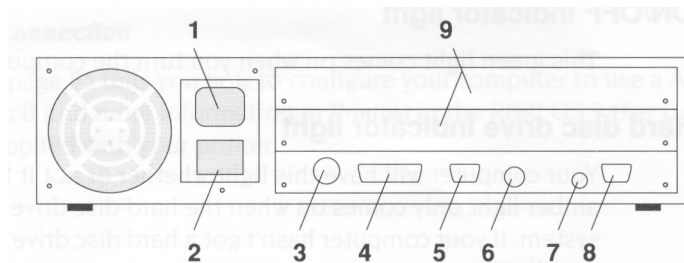

The following subsections describe the connectors on the back of the computer (an asterisk (*) after a signal name denotes active low):

1 Monitor power outlet

You can attach the power cable of **most** types of monitor to this outlet (check with your supplier). Its output is controlled by the ON/OFF switch on the front of the computer. The maximum continuous rating for this outlet is 1A @ 220V AC.

Note: This outlet is intended for connecting monitors ONLY.

2 Computer power connector

Use this three-pin connector to connect the computer to a standard power outlet.

3 Econet network (optional)

(Requires optional Econet network expansion card to be fitted.) This needs a 5-way DIN plug to go into the 5-way DIN socket on the back of the computer.

The Econet socket is wired as follows:

Pin	Signal	Pin	Signal
1	DATA+	2	0V
3	CLOCK+	4	DATA-
5	CLOCK-		

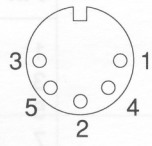

Use this socket to connect the computer with other Acorn computers on an Econet local area network (LAN). A LAN allows you to communicate with several computers within a single geographic location. To use the Econet network, you must install an optional Econet expansion card in the machine. A blanking plug may have been fitted to this socket if the Econet expansion card is not installed. See your supplier for more information on the Econet expansion card.

4 Parallel printer

A parallel printer needs a 25-way D-type plug to go into the 25-way D-type socket on the back of the computer. Parallel and serial printers are discussed in *Appendix C: Attaching peripheral devices*.

The pins on the plug are as follows:

Pin	Signal	I/O	Pin	Signal	I/O
1	STROBE*	I/O	2	D0	I/O
3	D1	I/O	4	D2	I/O
5	D3	I/O	6	D4	I/O
7	D5	I/O	8	D6	I/O
9	D7	I/O	10	ACKNOWLEDGE*	I
11	BUSY	I	12	PAPER ERROR	I
13	SELECT	I	14	AUTO FEED*	O
15	ERROR*	I	16	RESET*	O
17	SELECT IN*	O	18	0V	N/A
19	0V	N/A	20	0V	N/A
21	0V	N/A	22	0V	N/A
23	0V	N/A	24	0V	N/A
25	0V	N/A			

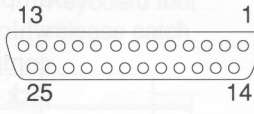

5 Serial port

The serial port on the back of the computer is a 9-way D-type plug. A serial device to be connected here needs a 9-way D-type socket on the end of its lead. Refer to the documentation accompanying your particular communications package for information on how to wire the lead to be used with the serial port. There is also some information in *Appendix C: Attaching peripheral devices*.

The pins on the plug are as follows:

Pin	Signal	Pin	Signal
1	DCD I/P	2	RXD O/P
3	TXD O/P	4	DTR O/P
5	0V	6	DSR I/P
7	RTS O/P	8	CTS I/P
9	RI I/P		

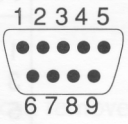

6 Keyboard connector

The keyboard has a 6-way plug on the end of its cable, that goes into the 6-way socket on the back of the computer:

The pins on the socket are wired as follows:

Pin	Signal	Pin	Signal
1	RESET	2	No connection
3	0V	4	5V
5	Serial data in	6	Serial data out

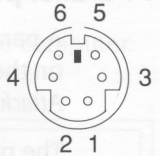

7 Headphones

The headphones 32 Ohm socket allows you to connect stereo headphones or your stereo amplifier system to the computer, through which you can hear sound produced by the computer. The lead must have a 3.5mm stereo jack plug.

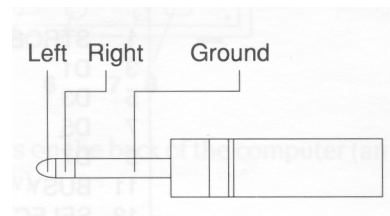

8 Video

This 15-way D-type socket is used to connect your monitor to the computer (it is not suitable for TTL RGB monitors).

The pins on the socket are as follows:

Pin	Signal	Pin	Signal
1	RED	2	GREEN
3	BLUE	4	ID<2>
5	TEST (0V)	6	R return (0V)
7	G ret (0V)	8	B ret (0V)
9	+5V (750mA fuse)	10	0V
11	ID<0>	12	ID<1> (I/P / SCART slow switching O/P)
13	HSYNC	14	VSYNC/CSYNC
15	ID<3>		

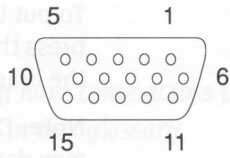

See *Appendix B: Monitor connections* on page 69 for information on monitors that use this socket. See your supplier for information on the types of colour monitors that work with the computer.

9 Expansion card blanking panels

The blanking panels cover any expansion card slots not in use. It's not a good idea to operate the computer with these removed.

Expansion cards make your computer more versatile. Ask your supplier about expansion cards that might be useful to you.

Keyboard

The functions of the various keys are described in *Using the keyboard* on page 37. What follows here is a description of the back of the keyboard and how to connect it, and the mouse, to the computer.

The drawing below shows the back of the keyboard.

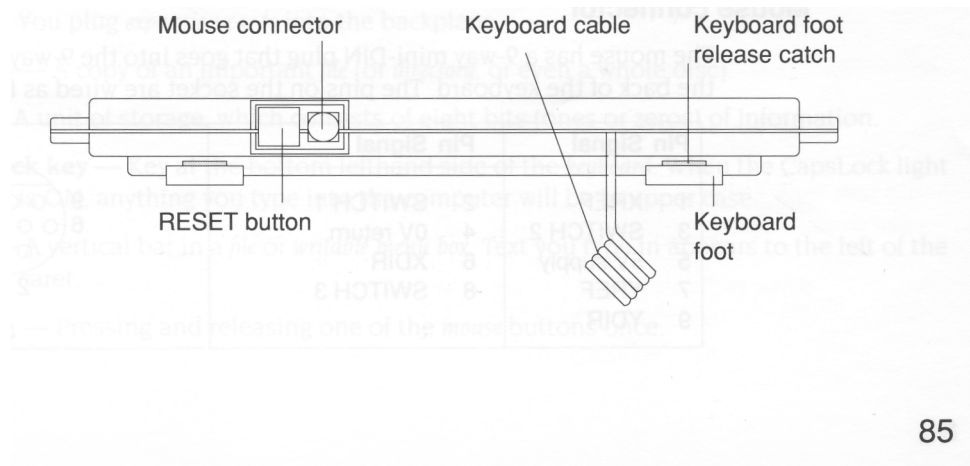

Keyboard feet

You can pull these down, making the keyboard slope more steeply. You can choose one of two angles of rake.

To put the feet back in their original positions (flush with the rest of the keyboard) press the keyboard foot release catch before pushing each foot back into place. See the diagram of the back of the keyboard on the previous page.

Note: Don't try to move the keyboard feet without pressing the release catch; you may damage the feet, or break them off.

RESET button

The RESET button is used to restart the computer without turning it off at the ON/OFF switch (press Ctrl RESET). Refer to the RISC OS 3 *User Guide*.

Warning: You'll lose any unsaved work when you do this.

Mouse connector

Use this 9-way connector to attach the mouse cable to the keyboard (the other end of the cable is permanently fixed to the mouse).

Keyboard cable

The coiled keyboard cable to the right of the mouse connector is permanently attached to the keyboard. It connects the keyboard to the computer.

Mouse

The mouse has a cable with a connector on the end which you plug into the 9-way connector on the back of the keyboard. Using *the mouse* on page 13 tells you how to use the mouse.

Mouse connector

The mouse has a 9-way mini-DIN plug that goes into the 9-way mini-DIN socket on the back of the keyboard. The pins on the socket are wired as follows:

Pin	Signal	Pin	Signal
1	XREF	2	SWITCH 1
3	SWITCH 2	4	0V return
5	5V supply	6	XDIR
7	YREF	8	SWITCH 3
9	YDIR		

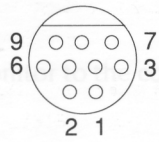

Glossary

This glossary defines any new terms that you may have come across in the guide. Terms in italics have their own definitions in this glossary.

- ADFS** — Advanced Disc Filing System (see the RISC OS 3 User Guide for more information).
- adjust button** — Righthand *mouse* button.
- adjust size icon** — *Icon* in the bottom righthand corner of some *windows*. Drag this to change the size of a window.
- application** — A program you use to perform tasks or play games on the computer.
- application directory** — Similar to an ordinary *directory*, in that it contains other *files* or *directories*. Name starts with an exclamation mark (!). *Double-clicking* on an application directory starts the *application* (rather than just opening the directory).
- application icon** — Icon that appears on the *icon bar* when you start an *application*.
- Apps icon** — An *icon* that is always present on the lefthand side of the *icon bar*. *Clicking* on this will give you access to the *applications* stored permanently in the computer's memory (ROM) such as Draw and Paint.
- auto-start** — You can configure the computer so that any or all of the ROM *applications* in the Apps directory will automatically start every time you switch on.
- back icon** — *Click* on this to send a *window* to the back of a pile of windows on the screen. Click on the *title bar* to bring it to the front again.
- backplane** — A small printed circuit board (PCB) sticking out vertically from the main PCB. You plug *expansion cards* into the backplane.
- backup** — A copy of an important *file* (or *directory*, or even a whole disc).
- byte** — A unit of storage, which consists of eight bits (ones or zeros) of information.
- CapsLock key** — Key at the bottom lefthand side of the *keyboard*. When the CapsLock light is ON, anything you type into the computer will be in upper case.
- caret** — A vertical bar in a *file* or *writable menu box*. Text you type in appears to the left of the caret.
- clicking** — Pressing and releasing one of the *mouse* buttons once.

- close icon** — Click *Select* on this to close a *window* or *directory display*. Click *Adjust* to close the window and simultaneously open its *parent*. Press *Shift* and click *Select* on this to close a window and leave its *icon* on the *Pinboard*. (Double-click on the *icon* on the *Pinboard* to open it). Press *Shift Adjust* to open the parent without closing the window.
- computer control keys** — These include the following keys: *Tab*, *Ctrl*, *Shift*, *CapsLock*, *Alt*, *Return*, the arrow keys, *Delete*, *Insert*, *Home*, *Copy*, *Page Up* and *Page Down*.
- default** — A standard setting or option, which the computer uses unless you tell it to do something else.
- Delete key** — The function of this key depends on what *application* you are using. For instance, in *Edit* (or a *writable menu* box) press this key to delete a character to the left of the *caret*. In *Draw*, press this key to delete a selected object.
- desktop** — Area of the screen display where you run *applications*, open *windows* and so on.
- destination disc** — When making a *backup*, you copy information **from** an original *source* disc **to** a blank, formatted destination disc.
- devices and device icons** — Devices really means storage devices – places where information (*files*, *directories* or programs) is kept. *Click* on the device icon (on the lefthand side of the *icon bar*) to see what is stored on the associated device.
- directory** — Storage area – like a folder – in which you can keep *files* or *subdirectories*.
- directory display** — *Window* that displays the contents of a *directory* or storage *device*.
Double-click on a directory to see its directory display.
- disc** — See *floppy* discs.
- disc eject button** — Make sure the *drive indicator light* is out before you press this to *eject* a *floppy* disc.
- double-clicking** — Pressing and releasing the *Select* or *Adjust* button twice in quick succession.
- double-click arrow** — When you double-click on an object, the *pointer* will change to a double-click arrow just after the first click. You have to make the second click before the pointer reverts to its normal shape.
- double density floppy discs** — Floppy discs capable of holding about 800KB of information when formatted.
- drag** — Press and hold down the *Select* or *Adjust* button and move the mouse, whilst the *pointer* is over the object you want to drag.
- drive indicator light** — This is an LED that lights when the disc drive is being used by the computer. There is one for the hard disc drive (if your computer has one) and one for the floppy drive.

- Econet** — This is a means of connecting two or more computers together so that they can communicate with each other and share information. It is a type of Local Area Network (LAN) produced by Acorn. Contact your supplier for details.
- eject** — Press the *disc eject button* to eject a *floppy disc*.
- Ethernet** — Another type of LAN, developed by Xerox Corporation.
- expansion card** — An extra PCB fitted to your computer that will make it more versatile and powerful. Expansion cards are available from your supplier.
- file** — A collection of information bundled together and given a name to identify it. For instance, a letter written on a word processor, a program, a *palette* definition.
- file access** — Controls who else can look at or change any of your *files* if your computer is connected to a network (like *Econet* or *Ethernet*).
- file locks** — Prohibit other users on a network from looking at or changing your files and prevent you from accidentally deleting files you have protected.
- File menu** — *Menu* displayed when you click Menu over a directory display.
- filing system** — (e.g. ADFS) — A logical and structured way of storing and manipulating *files*. See the RISC OS 3 *User Guide* for more information.
- floppy discs** — Removable discs for storing information. Your computer uses 3.5 inch floppy discs.
- font** — Typeface that the computer uses (e.g. Homerton, Trinity).
- format** — Formatting a disc prepares it to receive information from the computer.
- function keys** — Set of keys along the top of the keyboard. What they do depends on which *application* you are using.
- hard disc** — A storage device fitted permanently inside the computer. Can hold much more information than a *floppy disc*.
- high density floppy disc** — Floppy disc capable of holding 1600KB (1.6 MB) of information when formatted under ADFS (1440KB under MSDOS).
- icon bar** — Strip along the lower edge of the *desktop* showing *icons* for *devices* and *applications* currently accessible from the computer's memory.
- icons** — Small pictures representing *applications*, *devices*, *files*, *directories* and so on.
- input focus** — When the input focus is on a particular file's *window*, you can alter that file (type in text, add graphics etc). The title bar and other icons on the window will change colour.
- keyboard** — Built in or attached to computer by a curly cable. You use it to input information to the computer.

- kilobytes (KB)** — Unit of size relating to storage space in a computer. There are 2^{10} (1024) *bytes* in a kilobyte. A formatted high density *floppy disc* can hold about 1600KB. A *hard disc* can hold much more.
- letterbox** — A type of *screen mode* that is much wider than it is high, giving the appearance of a letter box.
- local area network (LAN)** — A general term for a network like Econet or Ethernet.
- megabytes (MB)** — There are 2^{10} (1024) *kilobytes* in a megabyte.
- memory** — The computer's information storage areas (see also RAM). If you try to run too many *applications* at once, you may run out of computer memory and have to remove some of the *applications* you are not using.
- menu** — List of actions you can choose from to perform on (or within) *files*, *directories*, *applications* and so on.
- Menu button** — Middle *mouse* button. *Click* it to display a *menu*.
- menu options** — See *menu*.
- modem** — Short for Modulator-Demodulator. A device that allows the computer to send and receive electronic signals via a telephone.
- monitor** — Screen unit (like a TV set) used to display communications from the computer. Monitors can be colour or monochrome (black and white). Also known as a Visual Display Unit (VDU).
- MonitorType** — A computer variable that determines which *screen modes* your *monitor* can display.
- mouse** — Small plastic box with three buttons on top and a cable attaching it to the computer. Hold it in your right hand, if you're right handed. Moving it moves the pointer on the screen.
- move** — Press Shift while *dragging* a file to move (rather than just copy) a file from one *directory* to another.
- numeric keypad** — Group of keys on the righthand end of the *keyboard*. When the light on the NumLock key is on, the keys perform the functions marked on them. With NumLock off, they may behave differently, depending on the *application*.
- operating system** — Actions and tasks you tell the computer to perform via the *desktop* are translated by the operating system into instructions that the computer can understand. RISC OS is the operating system used in this computer.
- palette** — Allows you to control the colours used to display different things on the *desktop*.
- parent directory** — A *parent directory* contains *subdirectories* and *files*. The files and subdirectories you see in a *directory display* are "children" of this parent directory.

peripheral — An item of hardware (e.g. a *printer*, *monitor* or *modem*) connected to your computer.

Pinboard — *Application* that makes use of the blank areas of the *desktop*. You can drag *icons* onto the desktop itself and they will 'stick' there (still in the computer's memory, just not open on the desktop).

pointer — Arrow displayed on the *desktop*. It moves when you move the mouse. Use it to *move*, change or select items on the desktop.

printer — *Peripheral* which prints *files* or documents onto paper.

printer driver — Program that converts *files* into information that your printer can understand and print.

printer manager — *Application* that oversees the printing process.

prompt — Signifies that you need to type in a command or supply information (e.g. the prompt that appears when you press F12).

quit — To close a *file* or *application* when you've finished using it, and remove its *window* from the screen.

RAM — Random Access Memory – part of the computer information storage system which is accessible for storing or retrieving information without using *discs*. Information in RAM is lost when the computer is switched off.

resources — The means with which your computer runs programs and *applications*.

Return key — Key on the *keyboard* that you press to signify the end of an instruction to the computer (e.g. when you've finished typing in a *file* name in a *writable menu box*) or to start a new line in an Edit file.

RISC OS — Stands for: Reduced Instruction Set Computer Operating System. See also *operating system*.

ROM — Read Only Memory – similar to RAM, but ROM doesn't go away when you switch the computer off. The *operating system* and several *applications* and fonts are permanently present in ROM.

root directory (\$) — The top-level directory in a filing system (all other *files*, *subdirectories* etc are contained in it).

save — Keep a permanent copy of a *file* in its current state (including any changes made since the last save).

SCART — Type of connector used to connect some types of monitor or TV to the computer. Gives better picture and sound quality than using an ordinary coaxial aerial cable.

screen mode — Governs the physical appearance of the *desktop* on your *monitor*.

scroll arrows — Arrows at either end of the *scroll bars* on *windows* that are not large enough to show all of a *file*.

scroll bars — Shaded bars along the righthand (and sometimes lower) edge of a *window*.

scrolling — Moving around a large *file* using the *scroll bars* and *scroll arrows*.

Select button — Lefthand *mouse* button. Use this to select items, choose *menu* options, *drag icons* etc.

self-tests — A series of tests performed by the computer when you switch on.

Shutdown — Menu option on the *task manager icon bar menu*. Choose this before you switch off the computer – it ensures that the computer shuts down 'gracefully'.

slider — Box within *scroll bar*. *Drag* it to move around a *file*.

source disc — See *destination disc*.

storage devices — See *devices*.

subdirectory — *Directory* in a *parent* directory.

submenu — *Menu* accessed by moving the *pointer* over an arrow on a main menu.

system application — Contains some of the *resources* that are common to all *applications*.

Task manager — Icon on righthand side of *icon bar*. Use it to control how the computer uses its memory.

title bar — Along the top of a *window* in which the name of the *file*, *application* or *directory* appears.

toggle size icon — *Icon* in the top righthand corner of a *window*. *Clicking* on this toggles between full size and the last size at which a window was displayed.

toggling — Switching something between two states, usually by clicking *Select*.

tracks — Areas defined on a disc when you *format* it, on which the computer stores information.

typewriter keys — Block of keys on the *keyboard* which resemble those on a typewriter.

window — Area of the screen designated for a particular activity or display – e.g. an *Edit* window (used to create a text file) or a *directory display* (used to display the contents of a disc).

writable menu box — A *submenu* option or part of a larger menu box. Either it already has a *caret* in it, or the *pointer* changes to a caret when it is over the box, indicating that you need to type in something (e.g. a file name).

write-protect — To lock a *floppy disc* so that the information on it cannot be changed in any way.

Index

A

- accented characters 41
- accessing - *see* files and floppy discs and hard discs
- Adjust button 14
 - choosing a menu option 27
 - closing files and directories 48
 - opening files and directories 48
 - selecting and deselecting icons 51
- adjust size icon - *see* windows
- Alt key - *see* keyboard
- Analogue RGB socket
 - pinout 84
- applications
 - 1st Word Plus 43
 - application directories 47
 - Edit 43
 - hints and tips 46
 - Maestro 9, 47
 - quitting 45, 61
 - resources 46
 - saving your work 44, 50
 - starting 43, 48
 - using 43-46
 - using from floppy discs 43
- Apps
 - directory 17, 43
 - icon 17

B

- back icon - *see* windows
- backup - *see* floppy discs and hard discs

C

- CapsLock key - *see* keyboard
- caret 28
 - moving in Edit 44
- cleaning the computer, monitor and keyboard 67
- clicking 14, 15
- close icon - *see* windows
- closing files and directories with Adjust 48
- computer
 - cleaning 67
 - diagram of rear panel 82
 - front panel diagram 81
 - ON/OFF switch 7
 - switching off 9
 - switching on 7
- computer control keys - *see* keyboard
- connecting mouse and keyboard 3
- Copy key - *see* keyboard
- copying files 51
- copying text or objects 40
- creating a new directory 49
- creating a work disc 49
- Ctrl (control) key - *see* keyboard
- Ctrl RESET
 - restarting the computer 62, 64
- Ctrl U
 - deleting defaults in writable menu boxes 28
 - cursor
 - moving - *see* keyboard
- cursor keys
 - see also* keyboard

D

- default
 - definition 88
- default names
 - deleting with Ctrl U 28
- Delete key – *see* keyboard
- deleting files 52
- deleting text or objects 40
- desktop 9, 11
- destination disc 35
- device icons 12
- directories
 - closing with Adjust 48
 - creating 49
 - icons 47
 - naming 28
 - opening 47
 - restrictions on names 50
 - subdirectories 47
- disc eject button 30
- disc format errors – *see* floppy discs
- discs and disc drives 29-36
- double density floppy discs 31
- double-clicking 14, 15
 - loading a file 51
 - opening files and directories 47
 - starting applications 43, 48
- dragging 14, 16
 - dragging windows off the screen 19
 - dropping icons on the desktop—*see* Pinboard
 - printing a file 59
 - saving a file 51
 - starting applications 43

E

- Econet
 - pinout 83
- Edit
 - printing an Edit file 58
 - starting 44

- using 44
- efficient use of applications 46
- Escape key – *see* keyboard
- expansion cards 85

F

- file structure 48
- Filer menu 49
- files
 - accessing 53
 - application directory icons 47
 - closing 48
 - closing a file down to an icon on the background – *see* Pinboard
 - closing with Adjust 48
 - copying 51
 - deleting 52
 - icons 47
 - loading and saving 50
 - moving 51
 - naming 28
 - opening 47
 - restrictions on filenames 50
 - structure in a directory 48
- files and directories
 - max number allowed 48
 - naming 28, 49
- filing system 49
- flashing display – *see* troubleshooting
- floppy discs 12, 29
 - accessing 30
 - backups 35
 - care of 30
 - creating a work disc 49
 - disc eject button 82
 - disc format errors 33
 - disc insertion slot 82
 - drive indicator light 82
 - floppy disc drive 29
 - formatting 32
 - inserting and ejecting 30

- legal and illegal names 34
- picture of disc drive 81
- renaming 33, 34
- storage size 31
- write-protecting 31, 35

!Fonts 46

fonts 46

formatting – *see* floppy discs

function keys – *see* keyboard

G

getting the most out of applications 46

H

hard discs 12, 29

- accessing 30
- backing up important files 36
- disc errors – what to do 36
- drive indicator light 81
- parking drive heads – *see* switching off the computer

headphones socket 84

high density floppy discs 31

Home key – *see* keyboard

I

icon bar 11

- bringing to the front 19

icons 81

- directories 47
- displaying large or small icons 27
- files 47
- selecting and deselecting 51

IEC 320 outlet 82

input focus

- changing 45

inserting and ejecting floppy discs – *see* floppy discs

J

JP-150

- see* printing

K

keyboard 37-41, 85

- accented characters 41
- Alt key 40
- Caps Lock key 37, 44
- computer control keys 40
- connecting to computer 3
- connector 84
- Copy key 40
- Ctrl (control) key 40
- cursor keys 40
- Delete key 40
- Escape key 37
- features 85
- foot release catch 86
- function keys 37
- Home key 40
- mouse connector 86
- moving the feet 86
- multiple keystrokes 37
- numeric keypad 37
- Page down key 40
- Page up key 40
- RESET button 86
- Return key 44
- typewriter keys 37
- typing special characters 41
- using the keyboard 40

L

letterbox modes 75

loading a file 50

M

- Maestro 9, 47
- memory 90
- memory allocation
 - using the task manager 12
- Menu button 14, 25
 - displaying menus 26
- menus 25-28
 - applying to a file 26
 - applying to more than one file 26
 - cancelling 25
 - choosing options 26
 - displaying menus 14
 - displaying submenus 27
 - displaying with Menu button 25-26
 - Filer 26, 49
 - greyed-out options 25
 - icon bar menu 45
 - Menu button 14
 - Select all** option 26
 - Shutdown** option 61
 - submenus 27
 - writable menu boxes 28
- modems 77
 - connecting to serial port 78
- monitors
 - connecting to computer 4
 - supported types 75
 - switching on 7
- MonitorType 63
 - Auto setting 63, 75
 - setting 75
- mouse
 - buttons 14
 - connecting to computer 3
 - connector 86
 - connector pinout 86
 - dragging 16
 - holding 13
 - moving the pointer 13
 - techniques 14
- moving files 51

- multiple keystrokes – *see* keyboard
- multitasking (working in more than one window) 45

N

- naming files and directories 28, 49
- New directory** option 49
- no picture 63
- numeric keypad – *see* keyboard

O

- ON/OFF indicator light 81, 82
- ON/OFF switch 7, 82
- opening files and directories 47
 - using Adjust button 48
- operating system
 - RISC OS 11
- organising files and directories 48

P

- Page down key – *see* keyboard
- Page up key – *see* keyboard
- palette 12
 - setting the screen mode 76
- parallel port
 - attaching peripherals 77
 - hardware connection 79
 - pinout 83
 - printing 55
- parent 48
- peripherals
 - adding 77
 - connecting to computer 5, 77
 - switching off 62
- Pinboard 25
 - dropping icons on the desktop 53
 - iconising files 53
 - problems 65

pointer 12
 power
 connecting to computer 4
 shutdown 61
 printers 77
 connecting to computer 5, 77
 hardware connection on serial port 78
 hardware connection to the parallel port 79
 switching on 7
 printing 55-60
 !Printers 55
 activating printers 57
 configuration settings 55, 57
 connections 55, 57
 getting started 55
 loading printer drivers 56
 Paper feed option 57
 Print option 58
 Printer control window 56
 printer drivers 55
 printing a file 58-59
 printing a file by dragging 59
 printing an Edit file 58
 problems 60
 troubleshooting 60
 problems? 63

Q

quitting applications 45

R

RAM (Random Access Memory) 91
 renaming discs — *see* floppy discs
 RESET button 64, 86
 resizing windows — *see* windows
 resources 46
 restarting the computer 62
 RISC OS 11
 desktop 9, 11

ROM (Read Only Memory) 91
 root directory (\$) 46

S

safety standards v
 saving files 50
 saving work 44, 50
 SCART
 connecting monitor or TV 70
 pinout of connector 73
 screen modes 12, 75
 and memory usage 46
 setting with the palette 82, 76
 scrolling — *see* windows
 seeing what's on a hard or floppy disc — *see* floppy discs and hard discs (accessing)
 Select button 14
 opening files and directories 47
 selecting and deselecting icons 51
 self-tests 8, 65
 serial port
 attaching peripherals 77
 pinout 84
 printer connections 78
 Shift F12
 bringing the icon bar to the front 19
 Shift key
 typing upper-case letters 44
 shuffling windows — *see* windows
 shutdown 61
 slider — *see* windows
 source disc 35
 special characters
 typing 41
 starting applications — *see* applications
 stereo headphones
 connecting to computer 84
 structure — *see* files
 subdirectories 47
 submenus — *see* menus

switching off the computer 9
 shutdown procedure 61
switching on the computer 7
system applications 46

T

task manager
 memory allocation
title bar – *see* windows
toggle size icon – *see* windows
tools – *see* applications
troubleshooting 63
 printing 60
typewriter keys – *see* keyboard
typing special characters 41

U

unpacking the computer 1
using applications on floppy discs
 – *see* applications

W

where to put your computer 2
windows 17
 adjust size icon 18
 back icon 18
 close icon 18,20
 closing with Adjust 48
 dragging off the screen 19
 features 17
 manipulating 18-24
 obscuring the icon bar 19
 resizing 18
 scroll arrows 22
 scroll bars 22
 scrolling 21
 scrolling techniques 23-24
 shuffling 20
 slider 22
 title bar 17
 toggle size icon 18,19
work disc 49
working with more than one window – *see* input
 focus
writable menu boxes – *see* menus
write-protecting – *see* floppy discs

Reader's Comment Form

*Acorn A 5000 Welcome Guide
(Part number 0492,250)*

We would greatly appreciate your comments about this Manual, which will be taken into account for the next issue:

Did you find the information you wanted?

Do you like the way the information is presented?

General comments:

If there is not enough room for your comments, please continue overleaf

How would you classify your experience with computers?

<input type="checkbox"/>	<input type="checkbox"/>	<input type="checkbox"/>	<input type="checkbox"/>
First-time user	Used computers before	Experienced user	Programmer

Cut out (or photocopy) and post to
Dept RC, Technical Publications
Acorn Computers Limited
645 Newmarket Road
Cambridge CB5 8PB
England

Your name and address:

This information will only be used to get in touch with you in case we wish to explore your comments further



