

Acorn A4000 Welcome Guide



Acorn A4000

Welcome Guide



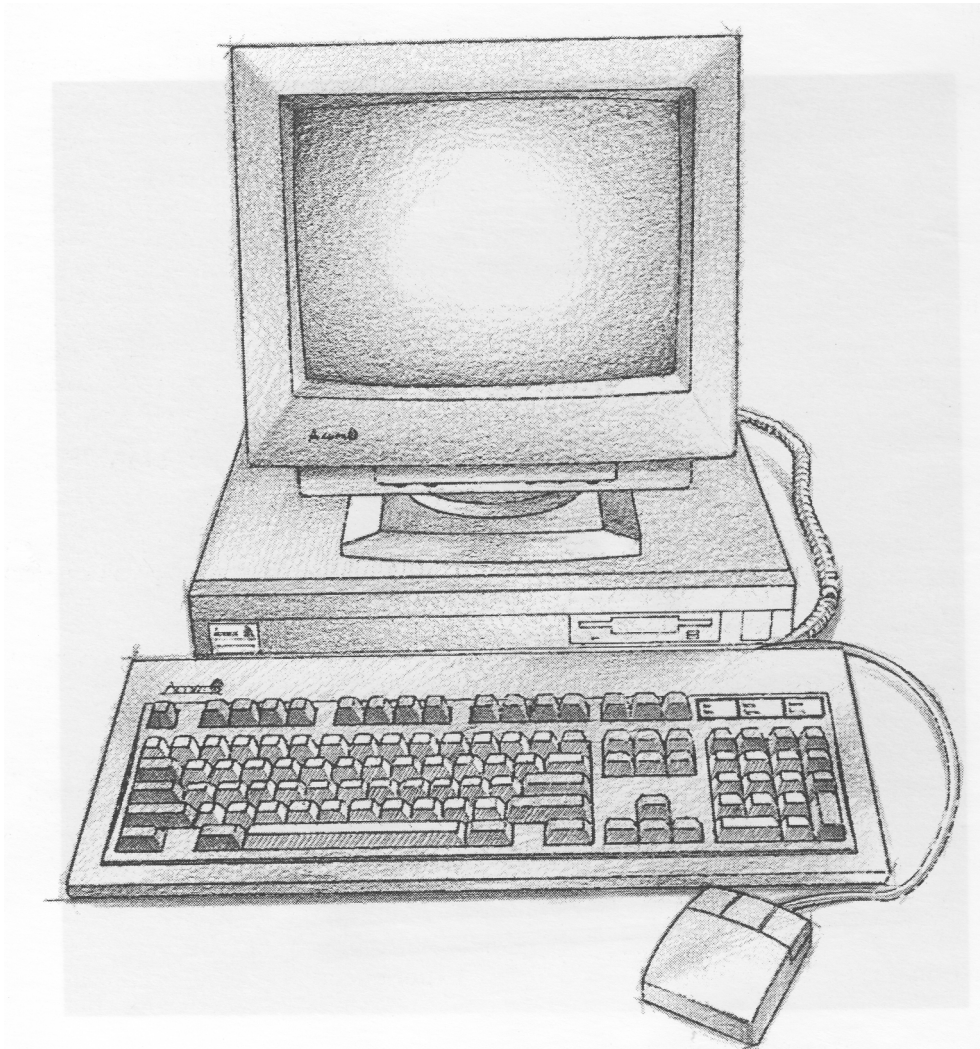

Welcome to the Acorn A4000 computer!

As the Acorn family grows larger, so our range of products continues to increase and diversify. Your new Acorn A4000 is the result of on-going development here at Acorn, and is made to the high standards of quality and reliability that existing Acorn users have come to expect.

We value your comments and feedback, so please let your supplier know of any suggestions you have as to how we might improve our service to you — the Acorn A4000 incorporates many such suggestions from existing Acorn owners. Your supplier will also assist you should you ever feel dissatisfied with any aspect of our product or service — Acorn suppliers have full support from Acorn itself.

To help us provide you with the best service, please complete and return the enclosed Owner Registration Form. This enables us to keep our valued and growing family of users informed about new developments. You are not of course obliged to answer all the questions, should you prefer to leave any of them blank.

The first part of this guide introduces the computer to you; it explains how to connect it together and how to start using it.

It doesn't matter if you've never used a computer before, the system is easy to use, and you need learn only a few simple techniques to get going. You can pick up the details as you go along.

The *Hardware reference* section gives you some advice about looking after your computer, along with more detailed information, which you may need to refer to when you want to add things like printers.

Once you have set everything up and mastered the basic techniques described in this guide, the RISC OS 3 *User and Applications Guide* also supplied will help you to get the best out of your computer and answer many other questions you may have about how the computer works.



Managing Director
Acorn Computers Limited

Copyright © 1991, 1992, 1993 Acorn Computers Limited. All rights reserved

Published by Acorn Computers Technical Publications Department.

No part of this publication may be reproduced or transmitted, in any form or by any means, electronic, mechanical, photocopying, recording or otherwise, or stored in any retrieval system of any nature, without the written permission of the copyright holder and the publisher, application for which shall be made to the publisher.

This product is not intended for use as a critical component in life support devices or any system in which failure could be expected to result in personal injury.

The product described in this manual and products for use with it are subject to continuous development and improvement. All information of a technical nature and particulars of the product and its use (including the information and particulars in this manual) are given by Acorn Computers Limited in good faith. However, Acorn Computers Limited cannot accept any liability for any loss or damage arising from the use of any information or particulars in this manual, or any incorrect use of the products. All maintenance and service on the product must be carried out by Acorn Computers' authorised dealers or Approved Service Centres. Acorn Computers Limited can accept no liability whatsoever for any loss or damage caused by service, maintenance or repair by unauthorised personnel.

If you have any comments on this manual, please complete the form at the back of the manual, and send it to the address given there.

Acorn supplies its products through an international distribution network. Your supplier is available to help resolve any queries you may have.

Within this publication, the term 'BBC' is used as an abbreviation for 'British Broadcasting Corporation'.

ACORN and ECONET are trademarks of Acorn Computers Limited

Apple is a trademark of Apple Computer Inc.

Atari is a trademark of Atari Corporation

DOS is a trademark of Microsoft Corporation

PostScript is a trademark of Adobe Systems Inc.

Centronics is a trademark of Centronics Data Computer Corporation

LaserWriter is a trademark of Apple Computer Inc.

Multisync is a trademark of NEC Limited

NEC is a trademark of NEC Limited

Panasonic is a trademark of Matsushita Electric Industrial Co. Ltd

Philips is a trademark of Philips Electronics Ltd

Taxan is a trademark of Kaga Electronics Co. Ltd

All other trademarks are acknowledged.

Published by Acorn Computers Limited

ISBN 1 85250 128 5

Part number 0494,650

Issue 5, June 1993

Guidelines for safe operation

The equipment described in this guide is designed and manufactured to comply with international safety standards EN60950 (BS7002) and is intended for use only as a desktop computer. It must not be used for other purposes. It is most important that unpacking and operation is carried out in accordance with the instructions given in this guide. In the interests of continued safe and reliable operation, observe the following guidelines'

- Keep the machine at a room temperature of +5°C to +35°C (+41° to +95° Fahrenheit) and a relative humidity of 20% to 80% (non-condensing). As a rough guide, if you feel much too hot, cold or humid, the conditions are probably too extreme for the computer as well.
- Avoid sudden extremes in temperature, exposure to direct sunlight, heat sources (e.g. electric fan heater) or rain.
- Stand equipment on a rigid horizontal flat surface, allowing enough space for air to circulate when in use.
- Ensure that any wires and cables are routed sensibly so that they cannot be snagged or tripped over. Don't tug or twist any wires or cables, or use them to hang or lift any of the units.
- Position the monitor at least 50cm away from other monitors (especially if back-to-back) to avoid interference.
- Make sure you've read and understood any installation instructions supplied with upgrade kits before attempting to fit them. If in doubt, contact your supplier
- Keep the original packaging in case you need to transport the computer.
- Keep the plastic bags contained in the packaging away from children.
- The equipment shall be installed near the power outlet, which shall be readily accessible.
- If you're going to move the computer, park the hard disc first.
- Switch off and unplug the equipment at night, or if you're not going to use it for a few days.
- Switch off and unplug the equipment and any accessories before opening the unit (e.g. to install an upgrade).
- The main computer unit should be operated with the top cover (which also acts as a fire enclosure) secured, to ensure the correct airflow through the unit.
- DON'T attempt to open any display or monitor, whether supplied with the equipment or not.
- DON'T drop the equipment or subject it to excessive bumping and jarring.
- DON'T spill liquid on the equipment. If you do, turn the equipment off immediately and take it to your supplier for assessment.
- DON'T obstruct, cover or poke objects through the ventilation openings in the computer casing or power supply
- DON'T exceed the maximum power consumption of 3 watts from the expansion card slot.
- DON'T balance any objects, or stand equipment weighing more than 25kg (33lbs) on top of this equipment.

Warning: this equipment must be earthed

If the plug supplied is not suitable for the power supply in your country, please consult your supplier.

UK information

The mains lead supplied with the power supply unit is already fitted with a moulded plug incorporating a 5A fuse. If it does not fit your socket-outlet, the plug should be removed from the mains lead **and safely disposed of**. The flexible cord insulation should then be stripped back as appropriate. A suitable alternative plug should then be fitted. If the replacement plug is intended to take a fuse, then a 5A fuse must be used. If you need to replace the fuse in the mains plug supplied, then you must use a 5A fuse ASTA-approved to BS1362.

As the colours of the cores in the AC power lead of this equipment may not correspond to the coloured markings identifying the terminals in your plug, proceed as follows:

- The core which is coloured green and yellow must be connected to the terminal in the plug coloured green and yellow, or marked by the letter E or by the earth symbol
- The core which is coloured blue must be connected to the terminal coloured black or marked with the letter N.
- The core which is coloured brown must be connected to the terminal coloured red or marked with the letter L.

Never use mains plugs with the fuse carrier omitted. If you lose the fuse carrier, either replace it with a carrier of the same type and manufacturer or replace the moulded plug with another mains plug, wired as detailed above.

Guarantee (valid in UK only)

This equipment is guaranteed by Acorn Computers Limited ("ACORN") against mechanical and electrical defects subject to the conditions set out below.

Note

Items which by their nature or design only have a restricted life are not guaranteed beyond such life.

Period of validity

This guarantee shall be valid for a period of twelve (12) months from the date of purchase.

Other conditions

- 1 This guarantee is personal to the original purchaser, is not transferable and shall not be valid unless the equipment was purchased from ACORN or from an approved ACORN supplier.
- 2 This guarantee will be invalidated if the equipment is misused or damaged or is modified in any way without the written consent of ACORN or if any original component or accessory has been replaced by any component or accessory of a type not recommended or approved by ACORN, or if operated other than in accordance with the *Welcome Guide* and *RISC OS 3 User and Applications Guide*
- 3 Any claims made under this guarantee must whenever possible be made through the supplier from whom the equipment was originally purchased. If this is not possible a claim may be made to any other approved ACORN supplier appointed by ACORN to service the equipment (a list of whom can be supplied on application). This guarantee together with proof of the date of purchase must be produced when any claim is made. Any costs of carriage to and from the supplier must be paid by the purchaser.
- 4 If ACORN agrees with the supplier that the equipment should be forwarded to ACORN for repair then ACORN will arrange for collection and return of the equipment at no charge. In all other cases the supplier will be responsible for effecting any necessary repairs in accordance with ACORN's service policy. Any repairs under this guarantee will be carried out at no cost to the original purchaser.
- 5 If any equipment returned is found to comply with its original specification ACORN reserves the right to charge a reasonable fee for testing the equipment and for return carriage.
- 6 The liability of ACORN under this guarantee shall be limited to the cost of repair or complete replacement (at ACORN's discretion) of equipment which proves to be defective.
- 7 ACORN does not accept liability for any loss or damage during transit to or from the supplier or ACORN, but every effort will be made to investigate claims of loss or damage if these arise.

THIS GUARANTEE DOES NOT AFFECT OR PREJUDICE THE PURCHASER'S STATUTORY RIGHTS.

Guarantee procedure

To claim under this guarantee, proof of date of purchase is required. This is provided by your copy of the invoice from the supplier from whom the equipment was originally purchased. Keep the invoice safe and produce it to support any claim you may make under this guarantee.

You may find it useful to make a note in the box below of the serial number, date of purchase and details of any upgrades you fit, and quote them in any correspondence.

Serial Number _____	Date of purchase _____
Upgrades _____	_____
_____	_____

Documentation roadmap

This roadmap will help you decide which tools and manuals you will need, as you start to use your Acorn A4000 computer and develop your skills

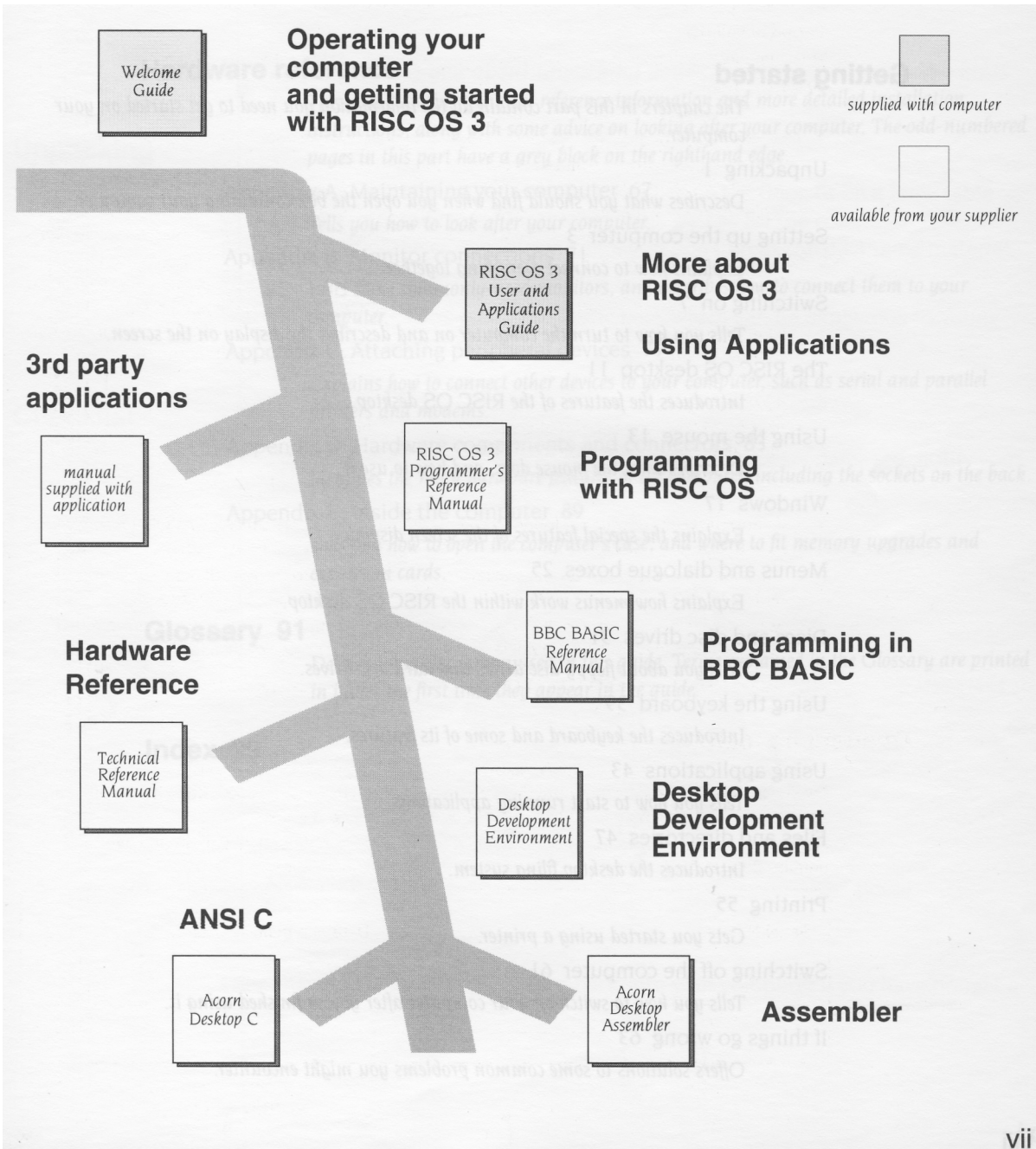

Contents

Getting started

The chapters in this part contain all the information you need to get started on your computer.

Unpacking 1

Describes what you should find when you open the box containing your computer.

Setting up the computer 3

Explains how to connect everything together.

Switching on 7

Tells you how to turn the computer on and describes the display on the screen.

The RISC OS desktop 11

Introduces the features of the RISC OS desktop.

Using the mouse 13

Describes what the mouse does, and how to use it.

Windows 17

Explains the special features of the screen display.

Menus and dialogue boxes 25

Explains how menus work within the RISC OS desktop.

Discs and disc drives 31

Tells you about floppy disc drives and hard disc drives.

Using the keyboard 39

Introduces the keyboard and some of its features.

Using applications 43

Tells you how to start running applications.

Files and directories 47

Introduces the desktop filing system.

Printing 55

Gets you started using a printer.

Switching off the computer 61

Tells you how to switch off your computer after you've finished using it.

If things go wrong 63

Offers solutions to some common problems you might encounter.

Hardware reference

This part contains technical reference information and more detailed installation instructions, along with some advice on looking after your computer. The odd-numbered pages in this part have a grey block on the righthand edge.

Appendix A: Maintaining your computer 67

Tells you how to look after your computer.

Appendix B: Monitor connections 71

Lists some commonly-used monitors, and describes how to connect them to your computer.

Appendix C: Attaching peripheral devices 79

Explains how to connect other devices to your computer, such as serial and parallel printers and modems.

Appendix D: Hardware components and connectors 83

Identifies the main hardware features of the computer, including the sockets on the back.

Appendix E: Inside the computer 89

Tells you how to open the computer's case, and where to fit memory upgrades and expansion cards.

Glossary 91

Defines computer jargon used in this guide. Terms explained in the Glossary are printed in italics the first time they appear in the guide.

Index 99

Unpacking

This chapter tells you about unpacking your computer, and gives some hints on where to set it up.

Unpacking

Unpack your computer on a flat surface — either on the floor, or on a large table where there's plenty of room for the carton as well as for the computer. Take everything out of the carton, making sure you don't break the packaging material, as you may need this later (to transport your computer).

Warning: the packaging contains plastic bags which can be dangerous to young children. Please keep them out of their reach.

Checklist

If you don't have all of these items, or if any of them appears damaged, notify your supplier immediately.

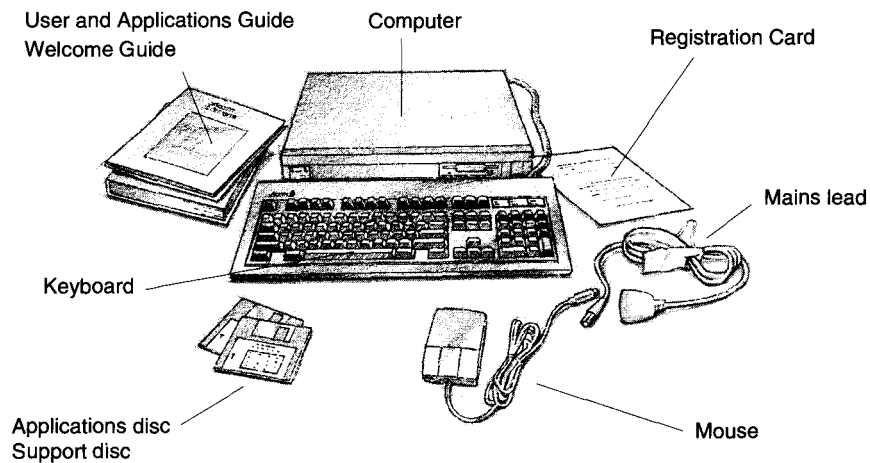

Other items may be included in the pack with your computer if you have bought a special complete system.

Checklist

Complete the Owner Registration Form and post it back to Acorn (purchasers outside the UK should send it to their local supplier or national distributor). This will enable us to inform you of new products and upgrades to your computer as they become available.

Put all the packing back into the carton and put it away somewhere safe. If you ever have to take the computer back to your supplier, you must pack it back into the original carton.

Bear the following points in mind when deciding exactly where to situate your computer:

- Don't place the computer where it will be exposed to direct sunlight, or any other source of heat, such as a radiator.
- Sunlight or reflections from a window will make it difficult to see things on the screen properly, so position your computer so that you can see the screen comfortably.
- Make sure the keyboard is at a comfortable height and position for you if you're going to type for long periods.
- Make sure the ventilation slots on the side of the computer are not obstructed.
- Make sure that any adjacent monitors are at least 50cm apart.

Setting up the computer

This chapter describes how to connect the components of the computer together and set it up ready for use. Before you start connecting it up, please read the Guidelines for safe operation in the front of this guide.

Connect mouse to keyboard

Take the *mouse* and the *keyboard* out of their plastic bags. The mouse has a straight cable with a plug on the end of it. This goes into the socket at the back of the keyboard.

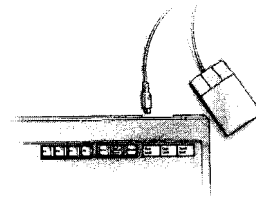

The plug has an arrow moulded into it; the arrow should be on the underside of the plug when you push it in. The plug won't go in any other way, so don't try to force it.

Connect keyboard to computer



Insert the plug on the end of the keyboard cable into the socket on the rear of the computer unit.

Make sure the arrow on the plug is uppermost. Don't try to force the plug.

Place the keyboard in front of the computer.

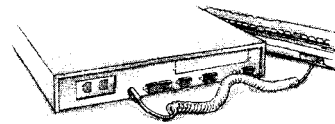

Connect monitor

You'll usually have two cables with each monitor:

- a signal cable (carries the video signal from the computer to the monitor)
- a power cable.

Connect monitor signal cable to computer

Put the monitor on top of the computer (unless you are using a monitor which weighs 25kg or more, in which case it will have to go alongside the computer unit, or on a strong shelf above it).

Depending on the type of monitor, the signal cable may be permanently attached to the monitor. If it isn't, push the **socket** end into the back of the monitor.



Push the **plug** end of the monitor cable into the socket on the back of the computer marked with the symbol on the left.

Note: If you have trouble, check in *Appendix B: Monitor connections* on page 71 – you might need an adaptor cable for your particular monitor.

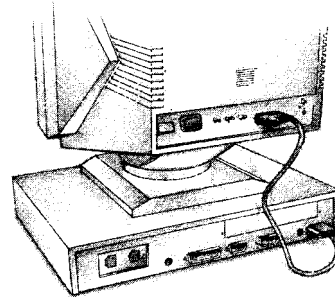

Connect monitor to power supply (but don't switch on yet)

The power cable for your monitor will have a socket on one end (like the type you connect to a kettle). Plug this into the power connector on the back of the monitor.

The other end of the monitor's power cable may have a standard power plug. If so, plug it into the power outlet on the wall.

However, if your monitor has an IEC-type power cable (with a **plug** on the end) plug this into the power outlet (marked 1A 220-240V) on the back of the computer. (Not all types of monitor may be connected to this power outlet. If in doubt, check with your supplier.)

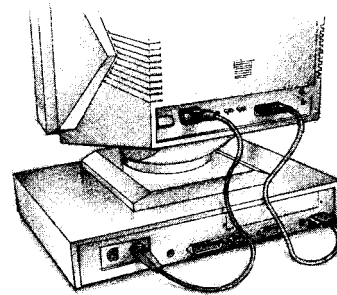

Note: The power outlet on the back of the computer is **ONLY** suitable for monitors.

Connect other peripherals to computer



Connect any other peripherals you have (such as a printer or a modem) **before** you switch on the power. Most printers use the parallel printer port on the rear of the computer. *Appendix C: Attaching peripheral devices* on page 79 gives you some advice.

Connect other peripherals to power supply (but don't switch on yet)

Connect the power cables for any other peripherals to power outlets on the wall.

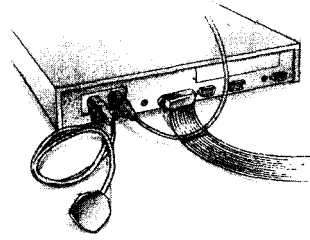

Connect computer to power supply

Finally, plug the connector on the computer power cable (the one that looks like the type you plug into a kettle) into the socket marked 2A 220-240V on the back of the computer unit. Plug the other end into the power supply outlet on the wall.

Don't switch on the power supply yet: follow the instructions in the next chapter.

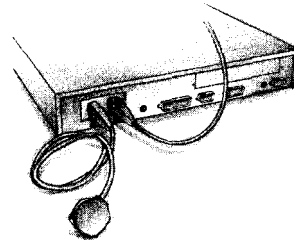

Switching on

This chapter tells you how to power up your computer for the first time, and describes what you see on the screen when you do.

Equipment check

First check that you have connected all parts of the computer together properly, as described in the previous chapter.

Before switching on the mains supply

Check that the monitor, printer (if you have one) and computer ON/OFF switches are set to OFF. The monitor and printer have separate switches. Their manuals will explain where they are.

The ON/OFF switch for the computer is on the front:

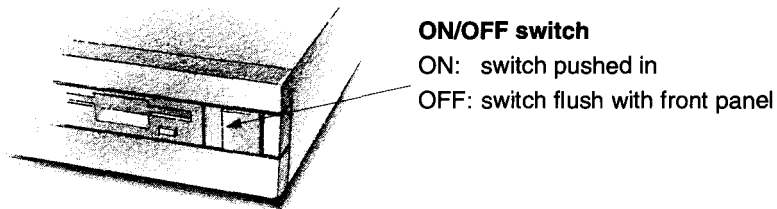

Switching on

- 1 Switch on the mains supply for the computer (at the power outlet on the wall) and that for the monitor (if its power cable is not plugged into the back of the computer) and printer (if you have one).
- 2 Switch on the monitor and printer.
The manual for your monitor will explain how to turn it on and, if necessary, adjust the brightness control. The manual for your printer will explain how to turn that on, too.

- 3 Switch the computer on, by pressing the ON/OFF switch on the front (the green light on the lefthand side of the computer's front panel will light up). Depending on your monitor (and whether it has warmed up yet) you might see the screen change colour while the computer performs some *self-tests*. The light on the floppy disc drive will also flash once when the drive is being checked. Next, you will see an introductory screen:

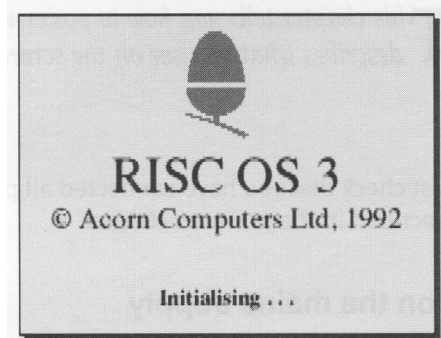

After a few seconds, you should have a picture on your screen, looking something like this:

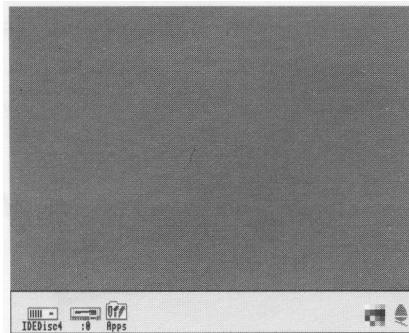

If the display does not look similar to that shown above (or if the floppy drive light flashes more than once) see *If things go wrong* on page 63.

What now?

Scenic route (for first-time users)

Now you're ready to begin using your computer. If this is the first time you've used a computer (or at least an Acorn computer) take the following route:

- 1 Use the rest of this guide to get used to the RISC OS *desktop*, and to learn how to use the computer efficiently. You'll need to know the basics explained here, whatever you use the computer for later, although you can probably do without this guide after a couple of weeks.
- 2 Try using some more of the programs supplied with your computer – they're described in the RISC OS 3 *User and Applications Guide*.
Check in the RISC OS 3 *User and Applications Guide* if you need more detailed information on a particular topic or technique.
- 3 Ask your supplier what other *applications* are available to suit your purposes.

If you want to stop for the moment, you can just switch off at the ON/OFF switch (and then switch off the monitor and any other peripherals too). Later on, when you've been using your computer a while, you'll find that it's better to follow the instructions in *Switching off the computer* on page 61.

Motorway route (for the more experienced)

If you're familiar with computers, mice, discs and so on, and you want to start doing something right away, start by trying out some of the computer's own *applications*. For example, play a tune with !Maestro (this will sound even better if you listen through a pair of 'personal stereo' headphones – see *Headphones* on page 86:

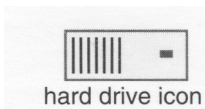

- 1 Click on the hard disc drive icon.
- 2 Double-click Select on the App2 directory.
- 3 Double-click on the Tunes directory.
- 4 Double-click on Fanfare (for example).
- 5 Click Menu (middle mouse button) over Fanfare's window to display a menu. Click Select on the **Play** option to start. Choose **Play** again to stop!

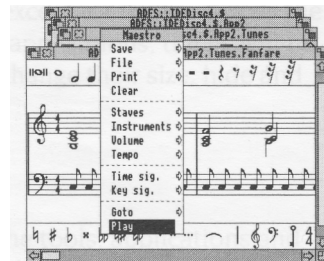

Don't despair if the above description sounds like it's written in a foreign language – just take the scenic route instead, and you'll pick up the jargon as you go.

The RISC OS desktop

An introduction to the desktop environment of RISC OS.

The RISC OS desktop

RISC OS is the name of the *operating system* of your computer; it controls the way the computer screen appears to you, and how the computer performs various actions and tasks. There's more on this subject in the RISC OS 3 *User and Applications Guide*, if you're interested.

By now, you should be able to see the RISC OS *desktop* on your screen:

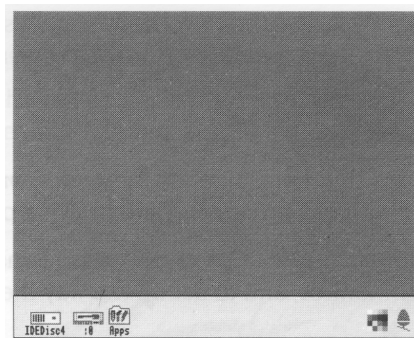

The desktop is your working area. At first it is clear, except for the bar across the bottom of the screen. As you perform tasks and use applications, things will be added to the desktop. You can move them around, change their size, hide and remove them to make room for others.

Icons

The pictures at the bottom of the screen represent the tools, applications and *storage devices* available. The pictures are called *icons*. The area they occupy is called the *icon bar*.

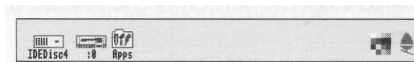

(Your icon bar may have more icons on the lefthand side — see overleaf).

Device icons

The icons on the left of the icon bar represent the *devices* which are available – that is, the discs and other places where you can load information from, and save it to. At least one will appear on the icon bar:

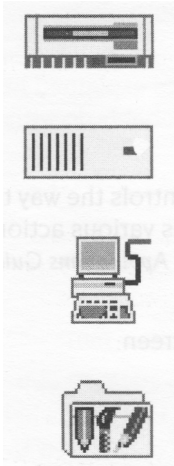

Floppy disc drive. The computer uses 3.5 inch *floppy discs*, which you put into the slot in the front of the computer. Floppy discs are described in *Discs and disc drives* on page 31.

Hard disc drive (if fitted). There is more about *hard discs* in *Discs and disc drives* on page 31.

Net (if fitted). If your computer is fitted with a *local area network* interface, there will also be a network icon. This lets you share information or equipment connected to other computers on the network.

Apps. This gives you access to some useful applications which are permanently stored in the computer's *read-only memory* (ROM).

Applications icons

On the righthand side are the *applications icons*. These represent things you can do, such as word-processing and drawing programs. Initially there are only two:

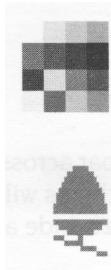

Palette. The *Palette* enables you to change the colours on the screen, depending on your monitor, and to set up the way the screen looks (the *screen mode*).

Task manager. The *Task manager* enables you to look at and control the allocation of your computer's memory, amongst other things. More information on this is given in the *RISC OS 3 User and Applications Guide* in the chapter entitled *Fine tuning the configuration*. You don't need to worry about this for now.

Any other applications which you load will normally be represented by icons on the righthand side of the icon bar.

The pointer



The arrow on the screen is the *pointer*. Use it to point at things you want to use or move.

You move the pointer across the screen by moving the mouse.

There are other types of pointer, which you will come across as you become more familiar with your computer.

Using the mouse

This chapter tells you how to use the mouse to select and move things displayed on the screen.

What's a mouse?

The mouse is one way of interacting with the computer (see *Using the keyboard* on page 39 for another). As you move the mouse on a flat surface, so the pointer moves around on the screen. Using the mouse and its three buttons you can control what the computer does.

Holding the mouse

Hold the mouse with the cable away from you so that your fingers rest easily on the three buttons. If you're right-handed, hold it like this:

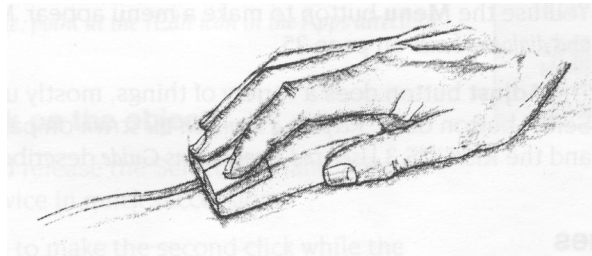

Move the mouse around and watch the pointer move around the screen. If you run out of space to move the mouse, lift it up and put it down again in a more convenient position. While the mouse is lifted, the pointer will not move, and when you put it down again you can carry on where you left off.

Use the mouse on a smooth but non-slippery surface. A mouse mat (available from your supplier) is ideal. Other surfaces on which the mouse works well are wood and glass.

The mouse will not work well on painted metal or highly varnished surfaces.

The mouse buttons

The mouse has three buttons, known as *Select*, *Menu* and *Adjust*:

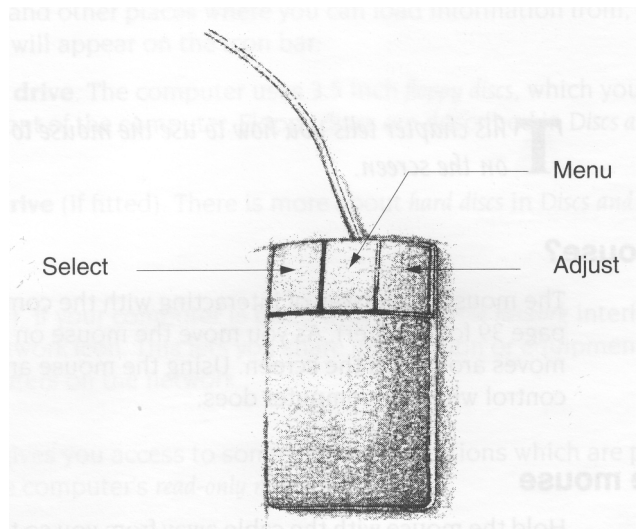

You use the **Select** button to select and move icons displayed on the screen, or to choose from *menus*.

You use the **Menu** button to make a menu appear. Menus are described in *Menus and dialogue boxes* on page 25.

The **Adjust** button does a variety of things, mostly useful variants of what the Select button does. *Keeping a menu on the screen* on page 27 includes one instance, and the RISC OS 3 *User and Applications Guide* describes many more.

Mouse techniques

The following mouse techniques are all you need to start using your computer:

clicking – pressing the mouse button just once and then releasing it immediately.

double-clicking – pressing and releasing twice in quick succession. This is used to load an application, for example.

dragging – moving an object from one place to another whilst holding down the Select (or Adjust) button.

Clicking and dragging techniques are described on the following pages. You can try out the examples in *italic text*.

Clicking

1 Point at the object

Move the mouse so that the pointer is over the object you want to select.

For example, point at the Apps icon on the icon bar.

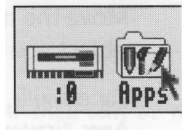

2 Click Select

Press and release the Select (lefthand) button of the mouse.

The Apps directory display will appear.

Note: From now on, 'clicking' means clicking with the Select button, unless otherwise stated.

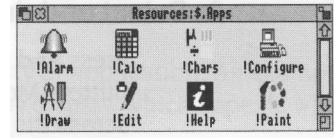

Double-clicking

1 Point at the object

Move the mouse so that the pointer is over the object you want to double-click on.

For example, point at the !Edit icon in the Apps directory display.

2 Double-click on the object

Press and release the Select (lefthand) mouse button twice in quick succession.

You have to make the second click while the second little arrow (the *double-click arrow*) which appears on the pointer after the first click, is still visible. If the icon is highlighted but nothing else happens, try again, but double-click a little faster. Try not to move the mouse while you're doing this.

Double-click on the !Edit icon. The Edit icon will appear on the icon bar, showing that the Edit application has been loaded ready for use.

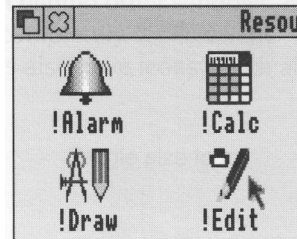

Dragging

1 Point at the object

Move the mouse so that the pointer is over the object you want to move.

For example, point at the title bar along the top of the Apps directory display. (The title bar is the part of the directory display containing the words Resources:\$.Apps.)

2 Select and drag the object

Press **and hold down** the Select (lefthand) button. Move the mouse to drag the object across the screen. Release the mouse button when the object is where you want it.

Drag the Apps directory display to a different position on the desktop.

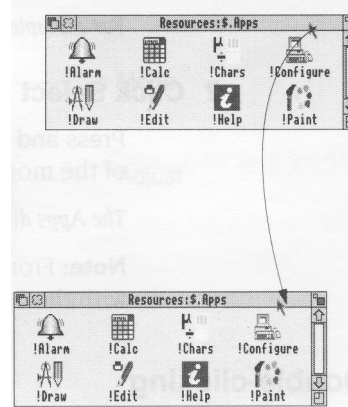

Windows

This chapter describes windows and explains how they can be moved, resized, hidden and closed. It describes how to move through the contents of a document too large to display in one window all at once.

What is a window?

A *window* is an area of the screen displaying an activity or application. An example of a window you have seen so far is the Apps directory display, which appears when you click on the Apps icon on the icon bar.

Features of windows

You can move windows around the screen, hide them behind other windows, close them to a small icon on the desktop, or close them completely. Icons on the windows allow you to do these things. Most windows also have icons which allow you to change their size.

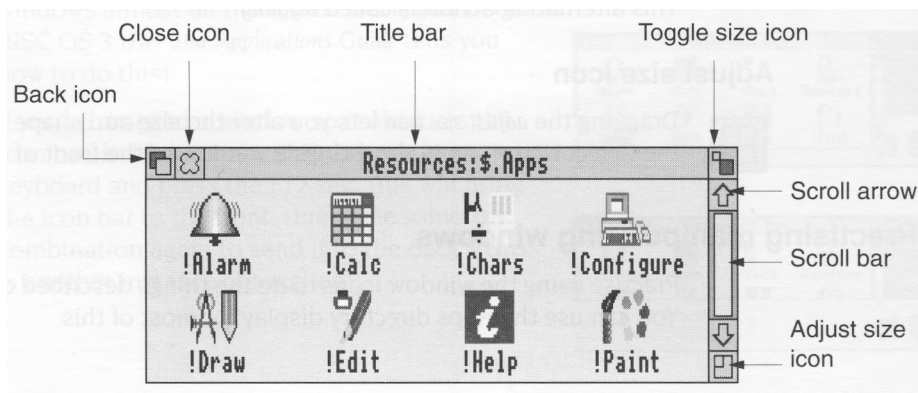

Title bar

The *title bar* displays the title of a window. This may be the name of an application, directory, or a document you're editing. Here's the title bar from the Apps directory display:



Back icon



Clicking on the *back icon* has the effect of putting a window to the back of the pile of windows on the screen. If you click on this, the window will be hidden behind any windows which overlap the area it occupies.

Close icon



Clicking on the *close icon* closes a window. If you click on this, the window will be removed from the screen.

Toggle size icon

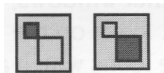

Clicking on the *toggle size icon* switches a window between full size and the last size displayed. (Full size is either large enough to display everything in the window, or such that the window fills the whole screen.)

This alternating action is called *toggling*.

Adjust size icon



Dragging the *adjust size icon* lets you alter the size and shape of a window. Clicking the Select button on it also brings a window to the front of a stack of windows.

Practising manipulating windows

Practise using the window icons to do the things described on the following pages. You can use the Apps directory display for most of this.

Changing a window's size



1 Point at the adjust size icon

Move the pointer over the adjust size icon.

2 Drag the adjust size icon

Press and hold down the Select button. Move the mouse and drag the icon to change the size of the window.

3 Release the mouse button

Release the button when the window is the size you want it.

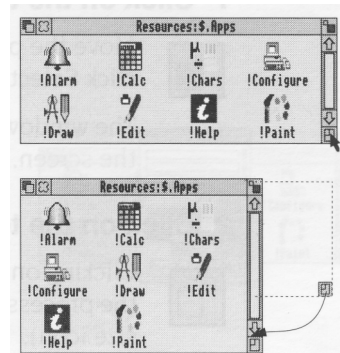

Moving a window

You move a window by dragging its title bar — follow the steps in *Dragging* on page 16.

By default, you can only drag a window to the edge of the screen before it stops. You can, however, set up the computer so you can drag windows almost off the screen (*!Configure* in the *RISC OS 3 User and Applications Guide* tells you how to do this).

If you've dragged a window so it obscures the icon bar, hold down the Shift key on the keyboard and press the F12 key. This will bring the icon bar to the front. (Press the same key combination again to send it to the back— this is another instance of toggling).

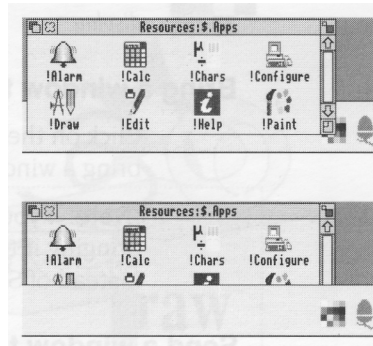

Toggling window size

1 Click on the toggle size icon



Move the pointer over the toggle size icon and click Select.

The window size will snap to nearly the width of the screen.

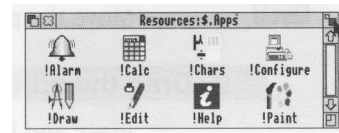

2 Click on the toggle size icon again



Clicking on the icon again will reverse the process (note the changing toggle size icon).

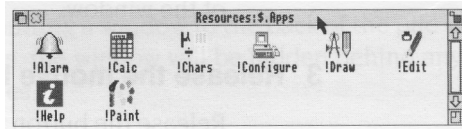

Bringing windows to the front

When you have a stack of windows on the screen, you can get at the one you want by sending windows to the back or bringing one to the front.

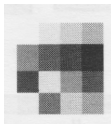

First, click on the palette icon on the icon bar to bring up another window. Drag it on top of the Apps directory display.

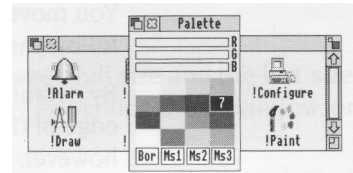

Bring a window to the front

Click on the title bar (or the adjust size icon) to bring a window to the front.

(Note: If you want to drag a window without bringing it to the front of a stack, use Adjust instead of Select.)

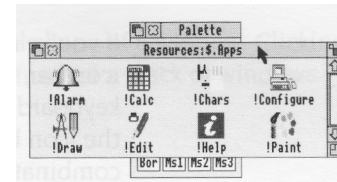

Send a window to the back



Click on the back icon to send a window to the back again.

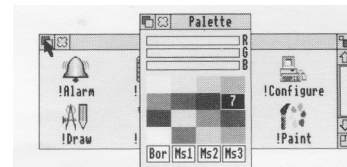

Closing windows

Click on the close icon



Position the pointer on the close icon and click Select.

For example, close the Apps directory display.

The window will disappear from the screen.

If it's an application window, and has some unsaved work in it (some changes you've made to a letter, for example) the application will usually ask you whether you want to save the changes.

Saving (and loading) a file on page 49 tells you how to save files.

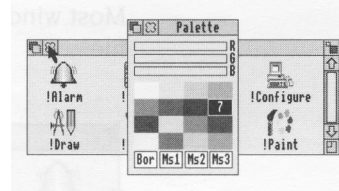

Scrolling

A window is so named because it allows you to see all or part of a file, application or whatever you've displayed on the screen. If a file is too large to display all at once, the window will only show a section of it. The proportion of the file visible depends on the size and shape of the window. The part of the file you can see alters as you move the window around the file:

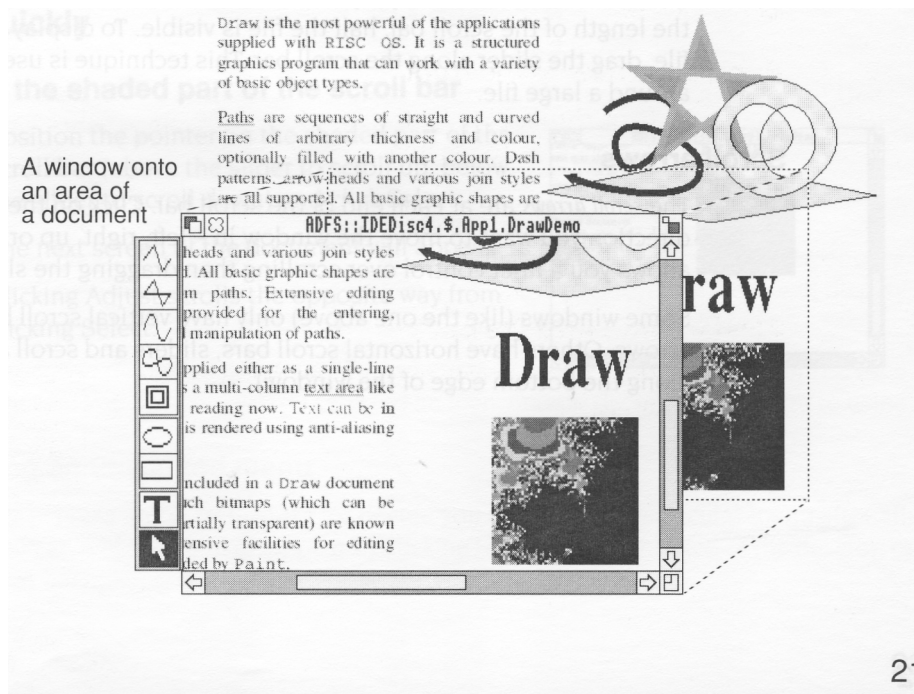

The technique of moving the window around a large file is called *scrolling*. You move the window frame over the file, but because the window actually stays in the same position **on the screen**, it appears as though the file is scrolling past the window.

This is not as complicated as it sounds. Tryout the techniques on the following pages, and you'll soon get used to moving around large files.

Most windows have scroll bars and scroll arrows to enable you to move around a file:

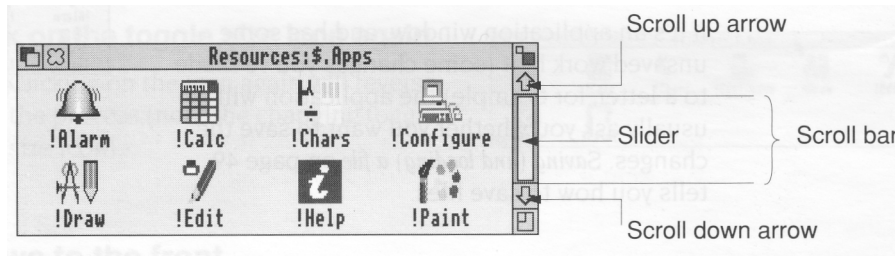

Scroll bars

The *scroll bars* allow you to scroll the window over the file, directory or picture you are viewing.

Slider

The slider size shows what proportion of the file is visible: if the slider occupies half the length of the scroll bar, half the file is visible. To display a different area of the file, drag the slider along the scroll bar. This technique is useful for moving quickly around a large file.

Scroll arrows

The *scroll arrows* are at each end of the scroll bar. Click on the arrow showing the direction you want to move the window in — left, right, up or down. This technique allows you a finer control over scrolling than dragging the slider.

Some windows (like the one above) only have vertical scroll bars, sliders and scroll arrows. Others have horizontal scroll bars, sliders and scroll arrows as well (they're along the bottom edge of the window).

Practising scrolling

Click on the hard disc drive icon, then double-click on Appl (if you're not sure about this, read the chapter *Discs and disc drives* first, then come back to this point).

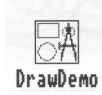

When the directory contents are displayed, double-click on the DrawDemo icon, and a window with scroll bars will appear, containing some drawings and text.

Practise the following scrolling techniques:

Scrolling a little at a time

Click on a scroll arrow

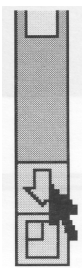

Position the pointer on the scroll down arrow and click Select to scroll down the drawing by small steps at a time.

Keep the Select button held down to continue scrolling.

Click Adjust to scroll back up. (Alternatively, click Select on the scroll up arrow.)

Use the horizontal scroll bar (on windows which have one) to scroll left or right a step at a time.

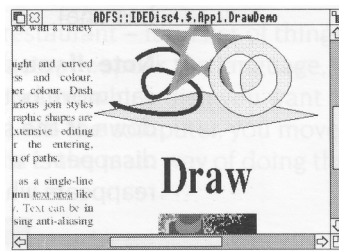

Scrolling more quickly

Click on the shaded part of the scroll bar

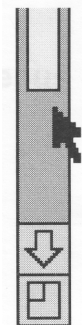

Position the pointer on the shaded part of the scroll bar (above the slider to scroll up, below the slider to scroll down) and click Select.

The next screen of the document will appear.

Clicking Adjust scrolls the opposite way from clicking Select.

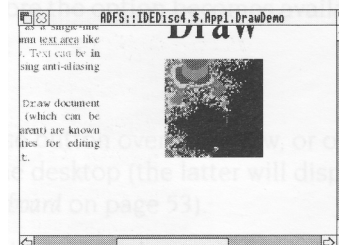

Moving through a file

1 Click on the slider

Position the pointer on the slider, press Select and keep it pressed down.

2 Drag the slider

Drag the slider to display the part of the file you want to view.

Move from one **side** of a document to the other by using the horizontal scroll bar (if the window has one).

Note: If you drag either slider with Adjust, you can move both from side to side and up and down at the same time. Try it. The pointer disappears while you're dragging a slider, then reappears when you release Adjust.

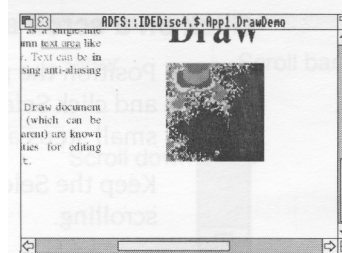
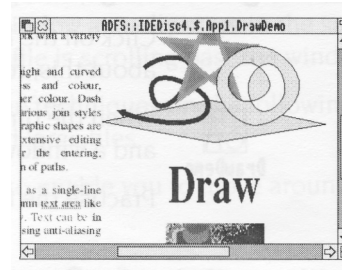

Menus and dialogue boxes

This chapter tells you what menus and dialogue boxes are, how to display them and choose things from them, and how to supply information when the computer asks you to be more specific about what you want.

What is a menu?

A menu in the desktop is similar to a menu in a restaurant — it's a list of things to choose from. In a foreign restaurant, if you can't actually speak the language, you can point at the menu with your finger to tell the waiter which dish you want (assuming that you know what the menu means!). On the computer, you move the mouse to point at your choice from the menu. This is the main way of doing things in the RISC OS desktop.

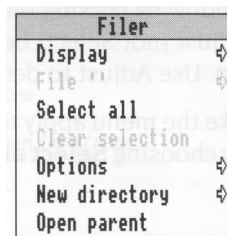

Menu options shown in grey (like **Clear selection** above) are not available at that time. Often you must perform another action before the option becomes available.

Using menus

To display a menu, click the Menu (middle) mouse button over a window, or over an icon on the icon bar, or over a blank area of the desktop (the latter will display the Pinboard menu — see the section entitled *Pinboard* on page 53).

The menu displayed will depend on where the pointer is on the screen at the time, whether you have previously selected an icon, and on the application you're using.

labelling

If you press Menu by mistake, or decide you don't want a particular menu after all, you can make a menu disappear by clicking Select on a blank area of the desktop or icon bar.

Displaying a menu

1 Point to the relevant icon

Move the pointer over the window or icon you're interested in.

For example, click on the Apps icon on the icon bar and move the pointer over the Apps directory display.

2 Click Menu

A menu will be displayed (*the Filer menu in this example*).

If the pointer is over a file icon when you click the Menu button (or if you had previously selected an icon by clicking on it) the menu will apply to that individual file.

You can make the menu apply to more than one icon in a window by clicking on each icon in turn with Adjust (not Select) before you bring the menu up. Use Adjust to deselect icons, too.

You can make the menu apply to all the icons in a window by choosing **Select all** from the menu — see below.

Choosing from a menu

With a menu displayed, click on the option you want (notice that menu options are highlighted as you move the pointer over them).

For example, on the Filer menu you displayed above, point at the **Select all** option and click Select. All the file icons in the directory display will be highlighted and the menu will disappear.

To reverse this, repeat the above process, choosing **Clear selection** instead. Alternatively, click on a blank area of the directory display.

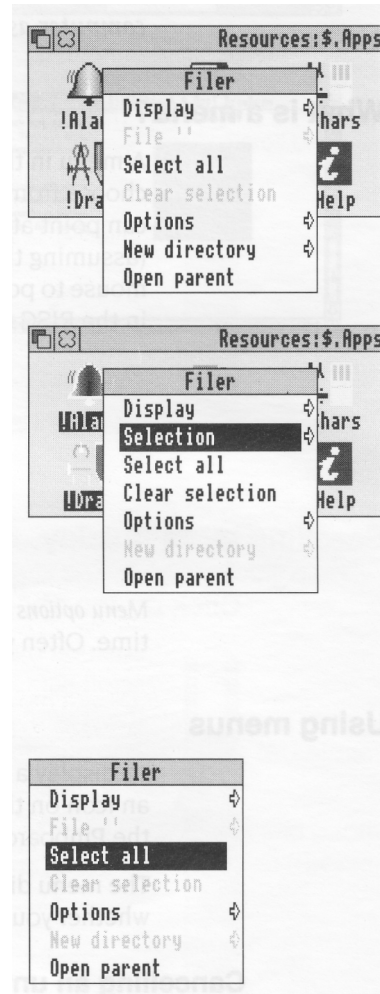

Keeping a menu on the screen

You'll notice that after you click Select to choose a menu option, the menu then disappears.

If you click with Adjust instead of Select, the menu will stay on the screen, and you can choose another option.

Choosing from a submenu

1 Highlight the main menu item

Move the pointer onto a main menu item with an arrow. An arrow to the right indicates that a *submenu* is available.

*For example, point at the **Display** option on the Filer menu.*

2 Display the submenu

Move the pointer onto the arrow.

*The **Display** submenu will appear on the screen.*

3 Click on the submenu item

Highlight and make your submenu choice by moving the pointer over it and clicking on it.

*Click on **Small icons**. The icons in the directory display will change size.*

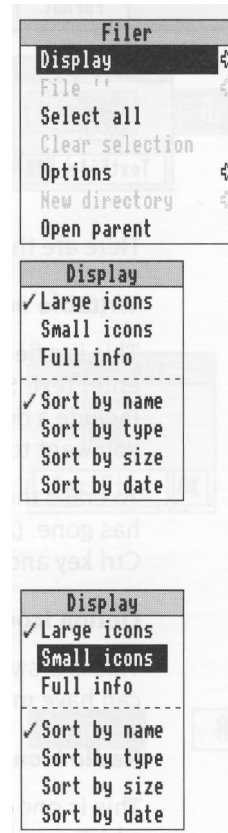

What is a dialogue box?

What is a dialogue box?

Sometimes related menu options are grouped together in *dialogue* boxes. They're called dialogue boxes because you have to reply to the computer's questions. You'll come across different types of dialogue box as you work through this guide or use applications. Here are some examples:

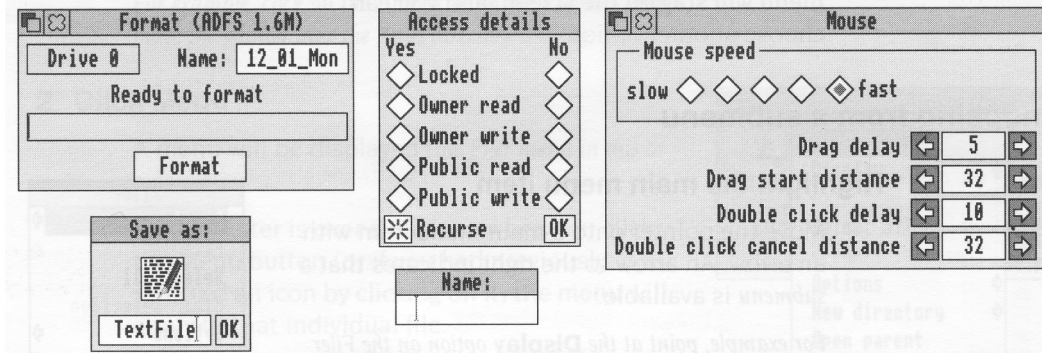

Here are the different icons you'll come across:

Writable menu option

This is a field, containing a caret, where you can enter text. Some fields are blank. Others include a default name, which you can change if you want to.

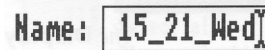

To erase the default name, press Delete until it has gone. (A quicker way is to hold down the Ctrl key and press U.)

Option icon

This is a 'switch' that can either be on or off. You can have more than one switch on at once.

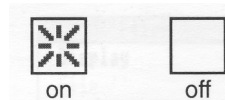

Radio icon

This is one of a group of 'buttons', only **one** of which may be selected at once (like the waveband selection buttons on a radio).

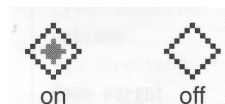

Arrow icon

This is an arrow you click on to increase or decrease numeric values.

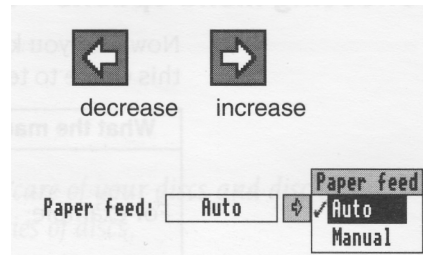
**Pop-up menu**

This is a text field with a single right arrow which, when you click on it, displays a submenu.

**Applying the changes you've made**

The way you apply the changes you've specified depends on the type of dialogue box. Some dialogue boxes have one or more buttons at the bottom for you to click on (such as Apply, or **OK**) ; others take effect as soon as you click on an arrow or radio icon.

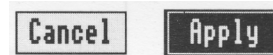

Some dialogue boxes only have a writable menu option (they're usually **Save as:** boxes). There are four ways of applying the name you supply in such a dialogue box:

- click on the name
- press Return
- click on OK
- drag the file's icon from the dialogue box to a directory display.

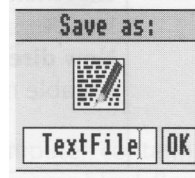

You'll find out more about this in *Files and directories* on page 47.

Cancelling a dialogue box

You can cancel a dialogue box by clicking on the Close icon (if it has one) or the **Cancel** button.



Choosing menu options - conventions in this Guide

Now that you know about menus, here are the conventions we'll use in the rest of this Guide to tell you how to choose menu options and fill in writable menu boxes.

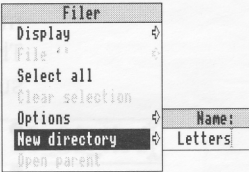
What the manual says	What you actually do	
<p>For example:</p> <p>Move the pointer over the Apps directory display, click Menu and choose Display/Small icons.</p>	<ol style="list-style-type: none"> 1 Move the pointer over the Apps directory display. 2 Click the Menu (middle) button. 3 Move the pointer to the right of the Display option. This opens the Display submenu. 4 Move the pointer over the Small icons option. 5 Click Select to choose the Small icons option. 	 <p>The screenshot shows a 'Display' submenu with the following options: 'Large icons' (checked), 'Small icons' (highlighted), 'Full info', 'Sort by name' (checked), 'Sort by type', 'Sort by size', and 'Sort by date'.</p>
<p>For example:</p> <p>Move the pointer over the directory display, click Menu and enter Letters into the New directory/Name: writable menu box.</p>	<ol style="list-style-type: none"> 1 Move the pointer over the directory display. 2 Click the Menu (middle) button. 3 Move the pointer to the right of the New directory option. 4 Use the Delete key to erase any existing default name. 5 Type in the name Letters for your new directory. 6 Click Select over the New directory writable menu box (or press Return) to enter the name. 	 <p>The screenshot shows a 'Filer' menu with options: 'Display', 'File', 'Select all', 'Clear selection', 'Options', 'New directory' (highlighted), and 'Open parent'. To the right, a 'Name:' field contains the text 'Letters'.</p>

Discs and disc drives

This chapter tells you how to use and take care of your discs and disc drives, and how to format and make backup copies of discs.

Floppy discs and hard discs

You store information and programs on hard or floppy discs.

Floppy discs

Your computer uses 3.5 inch floppy discs. They look like this:

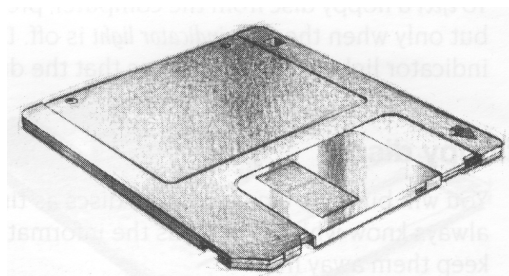

A number of floppy discs are supplied with your computer, containing useful programs (known as *applications*). You will also need some blank floppy discs, to save work of your own. You can obtain these from your computer supplier. *Floppy disc storage sizes* on page 33 tells you which discs to ask for. Before you use them, you'll have to *format* them (see *Formatting a floppy disc* on page 34).

You put the discs into the floppy disc drive (see *Inserting and ejecting floppy discs* on page 32). The drive can only take one disc at a time.

Hard discs

A hard disc is fitted to your computer. The amber light on the front panel of the computer will come on when the hard disc is active.

A hard disc can hold a lot more information than a floppy disc, and the computer can find information on it a lot faster.



The hard disc icon is on the lefthand side of the icon bar.

Inserting and ejecting floppy discs

The floppy disc drive is on the front of the computer.

Insert the disc into the floppy disc drive like this, with the label uppermost:

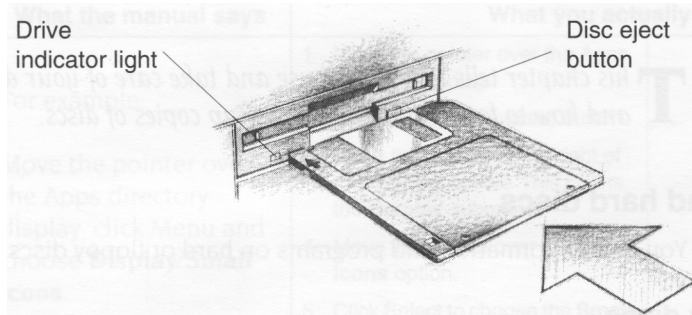

The disc clicks into place when it is fully inserted.

To *eject* a floppy disc from the computer, press the *disc eject button* below the disc slot, but only when the *drive indicator light* is off. Don't try to eject a disc when the drive indicator light is on; it indicates that the drive is still running.

Looking after floppy discs

You will build up a collection of discs as time passes. Label them so that you always know which one holds the information you need. Store them carefully and keep them away from

- extremes of temperature
- strong magnetic fields (e.g. TVs or loudspeakers)
- dust, dirt, drinks, pets etc.

Don't open the metal shutter on the disc, as the disc surface is easily contaminated by dust and small particles. For this reason, it's not a good idea to write on the labels in pencil: small pieces of pencil lead can easily get onto the disc surface.

Accessing information on discs

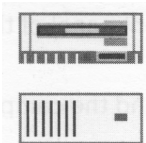

To see what's on a floppy disc, insert it into the floppy disc drive and click on the floppy disc drive icon on the icon bar.

Click on the hard disc icon to access information stored there

The contents of the disc will be shown in a directory display:

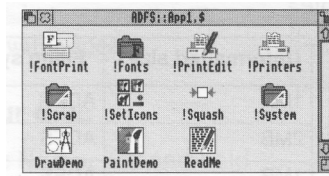

Write-protecting a floppy disc

If you *write-protect* a disc, it means that you cannot change anything on the disc, delete anything by mistake, or save any new files to the disc. You should write-protect discs containing any information you don't want to lose (and don't want to change at present).

To write-protect a disc, move the plastic tab (on the underside of the disc) towards the edge of the disc with your finger nail:

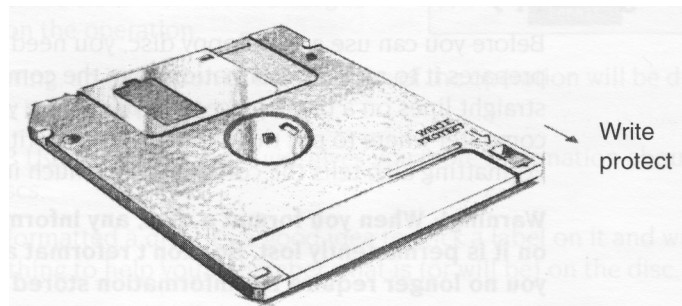

Remove write-protection by moving the tab back again.

Floppy disc storage sizes

Double density



High density

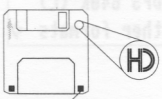

(extra hole)

Floppy discs are a bit like audio cassettes — they both store (or record) information. Some audio cassettes hold more information than others (for instance, a C90 holds more than a C60) even though they look the same physical size.

This is the same for floppy discs — the discs your computer uses are all 3.5" in size, but are available in different **storage** sizes.

You can use the following sizes of floppy disc with your computer:

- *double density* floppy discs, holding 800 *kilobytes* (800KB) when formatted (Acorn ADFS 800K (E) format)
- *high density* floppy discs, holding 1.6 *megabytes* (1.6MB) when formatted (Acorn ADFS 1.6M format).

Formatting a floppy disc

Your computer can also format discs for filing systems other than ADFS, as shown in the following table. To ensure reliability, only format discs in accordance with this table

Unformatted size*	Filing system	Formatted size	Density	
1MB	ADFS	800KB	double	DD
2MB	ADFS	1.6MB	high	HD
1MB	ADFS	640KB	double	DD
2MB	DOS	1.44MB	high	HD
1MB	DOS	720KB	double	DD
1MB	Atari	720KB	double	DD
1MB	Atari	360KB	double	DD

***Note:** The formatting information takes up some space on a disc, so the formatted size is slightly less. The following section describes how to format a disc.

Formatting a floppy disc

Before you can use a new floppy disc, you need to format it. Formatting a disc prepares it to receive information from the computer. This is rather like drawing straight lines on a blank piece of paper before you start writing on it. It tells the computer where to put the information — it writes along the lines (called *tracks*). Formatting also tells the computer how much information a floppy disc can hold.

Warning!: When you format a disc, any information that was previously stored on it is permanently lost. So, don't reformat a disc unless you are certain that you no longer require the information stored on it.

1 Make sure the disc is NOT write-protected

2 Insert the disc in the floppy disc drive

3 Display the Format dialogue box

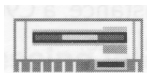

Move the pointer over the floppy disc drive icon on the icon bar and click Menu.

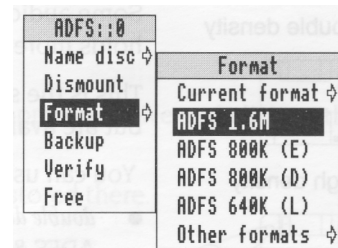

Choose **Format/ADFS 800K (E)** (or **Format/ADFS 1.6M**, if you've got a high density disc).

The Format dialogue box will appear:

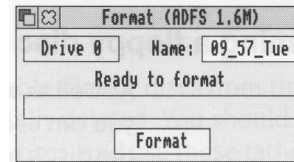

4 Decide on a name for your disc

Move the pointer over the **Name:** box and hold down the Ctrl key and press U to delete the default name. Then type in the name you've decided on. (See *Renaming a floppy disc* on page 36 for more information on disc names).

5 Format the disc

If you're sure you want to format the disc, click on **Format**.

If you don't want to format the disc after all, simply click on the close icon of the dialogue box to abandon the operation.

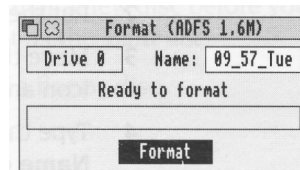

During formatting, an indication of the progress of the operation will be displayed. When the disc is formatted, click on **OK**.

The RISC OS 3 *User and Applications Guide* gives you more information about formatting discs.

When you've formatted a disc, it's a good idea to stick a label on it and write on a name — something to help you remember what is (or will be) on the disc.

Disc errors

If, while formatting is in progress, you get a message that looks like this

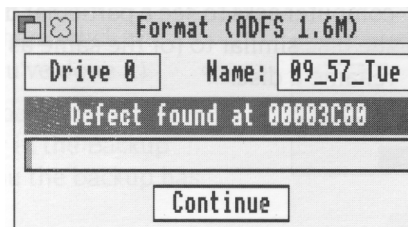

then the chances are your floppy disc is faulty. If you click on **Continue**, the computer will attempt to 'map out' any defects (no information will be stored on the faulty parts of the disc). You can use a disc with such defects, but there's always the chance it may prove faulty in the future, so, if you can afford to, it's probably best if you throw the disc away and use another one.

Renaming a floppy disc

As well as writing the disc's name on a sticky label so that **you** know what it's called, you can use the computer to name the disc electronically (so the **computer** knows the disc's name too).

If you don't choose names for your floppy discs when you format them, the computer will give them default names of the form 12 43 Tues. It's a good idea to give your floppy discs names which will help you remember what's on them (like BankLetter or Some_Pics).

Take the following steps to rename a floppy disc:

- 1 Make sure the disc you want to rename isn't write-protected.
- 2 Put the disc into the floppy disc drive.
- 3 Move the pointer over the floppy disc drive icon and click Menu.
- 4 Type the new disc name in the **Name disc/Disc name** writable menu option.

Note: The name must be at least 2 characters up to a maximum of 10, but you can't use any spaces, or the characters \$ & % @ \ ^ : . # * " |.

- 5 Click on the name, or press Return.

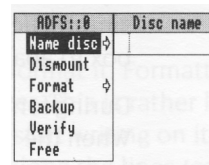

The disc now has a new name. To see it, click on the floppy disc drive icon on the icon bar. A directory display will appear, with the new name in the title bar. Remember to write the disc's name on its label.

Note: Always make disc names unique. You won't then get confused if the computer asks to see a particular disc. Also, make the name you physically write on the disc similar to (or the same as) the electronic name you type in when you rename a disc.

Making backup copies

It is a good idea to make a *backup* copy of any valuable files or discs from time to time, in case a disc is damaged or a file is accidentally deleted. You should also make backup copies of your program (application) discs, and use these rather than the originals, which you should keep safe. If you have a hard disc, the RISC OS applications are supplied ready installed on the hard disc, and you will run them from there. When you buy other applications, you should copy them to your hard disc for use, and keep the original discs safe.

Backing up a floppy disc

You'll need a blank disc (known as the *destination disc*) on which to make the backup copy. You can either use a brand new disc, or an old one which contains information you no longer need. You'll need to format a new disc before you can use it as a backup disc. It must be the same format as the *source disc*.

Take the following steps to make a backup copy of a floppy disc:

- 1 Write-protect the source disc (containing your valuable information) but not the destination (empty) disc.
- 2 Put the source disc into the floppy disc drive
- 3 Click Menu on the floppy disc drive icon on the icon bar and choose **Backup**. You'll see the Backup dialog box
- 4 Click on **OK** to start the backup. The computer will read the source disc.
- 5 Follow the rest of the instructions until backing up is complete – the computer will ask you to swap the source disc and destination disc while it transfers information between them (click on **Continue** each time you've done it).
- 6 Click on **OK** when the backup is complete (a message will appear in the Backup dialog box telling you the backup has finished).
- 7 Choose an appropriate name for the disc and write it on the disc's label.

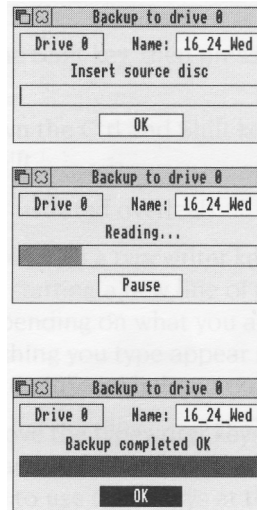

For more information on backing up floppy discs, and for quicker ways of doing it, see *Discs, networks and filing systems* in the RISC OS 3 *User and Applications Guide*.

Backing up files from a hard disc

Obviously, this only applies if your computer has a hard disc fitted.

If you have any files on your hard disc that you can't afford to lose, it's a good idea to keep backup copies of them on a floppy disc, in case your hard disc develops any errors. This can happen during the lifetime of a hard disc, but don't worry, it's not usually catastrophic! The RISC OS 3 User *and Applications Guide* tells you what to do if you do get any errors from your hard disc.

Format a blank floppy disc, and copy any important files from your hard disc onto it (see *Copying (and moving) a file to another directory* on page 51). Then rename your floppy disc to remind you what's on it.

Using the keyboard

This chapter describes the keyboard and its functions.

A quick tour of the keyboard

The illustrations on the next two pages show how the keys are laid out on the keyboard. This chapter describes the main features of the keyboard, and tells you how to use the different groups of keys. **Note:** Sometimes you need to press more than one key to perform an action. In such cases:

- 1 Press **and hold down** all except the last key in the sequence.
- 2 Press and release the last key in the sequence.
- 3 Release all the other keys.

For example:

- 'Press Shift F12' means press and hold down the Shift key, then press and release F12, then release Shift.
- 'Press Ctrl Shift F12' means press and hold down the Ctrl and Shift keys, then press and release F12, then release Ctrl and Shift.

The keys are divided into the following blocks (as illustrated overleaf):

The *typewriter* keys are in the main block, and are similar to a typewriter keyboard. The *Return* key on the right completes a line, either starting a new line of text, or sending a name or instruction to the computer, depending on what you are doing. The *CapsLock* key (when its light is on) makes everything you type appear in capitals. If you don't want this, press the key once to make its light go out.

The *function* keys (marked F1 to F12) are in a row above the typewriter keys. The function of these keys in a particular piece of software is often marked on a special keycard supplied with the software. You don't need to use these keys at the moment.

The *numeric keypad* is at the far right, laid out like a calculator. These keys can be used either to type numbers (when the NumLock light is on) or to perform special functions, depending on the program or application you are using.

The *Escape* key at the top left of the keyboard cancels an operation (e.g. printing) and may stop an application running.

The keyboard

The *computer control keys* have different functions, depending on the software with which they are being used. Useful keys to know about at the moment are:

- Delete** deletes a character to the left of the caret (e.g. in Edit) or deletes a selected object (e.g. in Draw).
- Ctrl (Control)** changes the meaning of a key, when held down while that key is pressed (there are two of these keys).
- Alt** changes the meaning of a key, when held down while that key is pressed (there are two of these keys).
- Copy** copies a selected object (e.g. in Draw) or deletes a character to the right of the caret (e.g. in Edit).
- Cursor keys** move the cursor (when it is visible) around the screen in the direction of the arrow on the key.

The keyboard

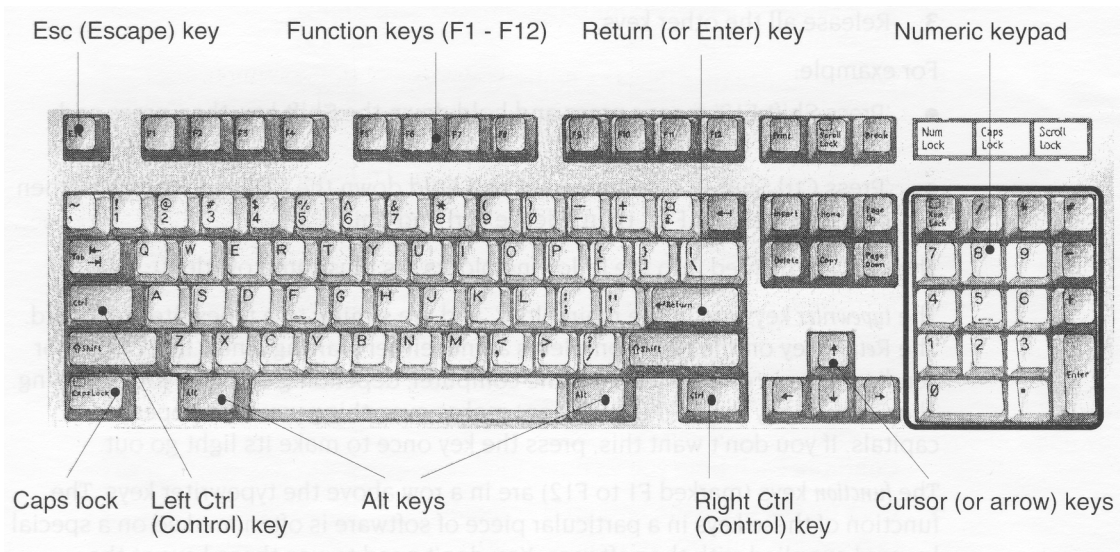

When to use the keyboard

You will need to use the keyboard for many tasks, such as

- supplying answers to questions the computer asks in writable menu boxes (including giving names to files and documents you create)
- using a word processor, or a text editor like Edit (for an example of this, see Using *applications* on page 43)
- choosing some menu options using keyboard short-cuts (for example F3 to **Save** a file)
- entering data in a spreadsheet or database.

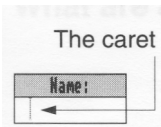

Whenever you need to use the keyboard within the desktop, a vertical bar appears. This is called a caret. Any characters you type will appear to the left of the caret, which will move to the right.

Moving around a document

Some other keys allow you to move to different parts of a document:

Home moves the caret to the start of the document

Page up moves to the previous 'windowful' of the document

Page down moves to the next 'windowful' of the document.

These keys have no effect in some applications (!Paint or !Draw, for example).

You can, of course, use the scroll bars and cursor keys to move around a document.

Typing special characters

Sometimes you need to be able to type special characters that are not apparently on the keyboard, such as accented characters, or symbols like ©. You can in fact get at lots of extra characters using the Alt key. The keyboard map at the bottom of this page shows all the characters that are available. Here's how to type them:

Typing accented characters



Some of the keys on the figure below are marked with a black area in one corner. These keys allow you to accent characters. The accent in each case is the character nearest the black area of the key.

For example, to type an 'e' with an acute accent (é):

- 1 Hold down the Alt key and press the [key.
- 2 Release the Alt key.
- 3 Press and release the E key.

Typing other special characters

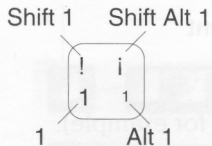

You can type the other special characters shown in the keyboard map using the instructions shown in the inset on the left.

For example, to type an upside-down exclamation mark (¡):

- 1 Whilst holding down the Shift and Alt keys, press and release the 1 key.
- 2 Release the Shift and Alt keys.

Special characters: keyboard map



Using applications

This chapter tells you how to load and run applications on your computer. It uses the application Edit as an example.

What are applications?



Applications, like Edit or Draw, are the tools that you use to produce your letters, drawings, music and so on. Application names always start with an exclamation mark (!).

Some applications (such as Edit) are provided in the Apps directory on the icon bar, others are in the Applications suite on disc. Many other applications and games are available from your supplier.

Starting an application

There are three main ways you can start an application:

- Double-clicking – move the pointer over the application's icon, and double-click.
- Dragging – move the pointer over the application's icon, then drag it onto the icon bar, and release.
- Double-clicking on an associated file – e.g. double-click on a Draw file to start Draw. This only works if the computer knows where to find the application (i.e. if it is in the Apps directory, like Draw or Edit, or if the directory containing its icon has been displayed since you last switched on).

1 Open the directory display containing the application

To use an application that is on a floppy disc, put the disc in the floppy drive and click on the floppy disc drive icon. This will open the root directory display for the disc.

To use one of the computer's own applications, like Edit, click on the Apps icon on the icon bar to show the Apps directory display.

Try this now as an example.

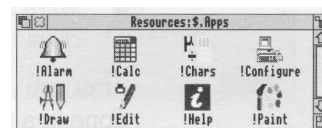

2 Start the application

Double-click on the application's icon. It will appear on the icon bar, ready for you to use.

For example, double click on !Edit. Its icon will appear on the icon bar, indicating that it has been loaded into the computer's memory, and is waiting for you to use it.

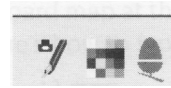

Some applications or games (like !Puzzle in App2) open a window as soon as you double click on their icon, instead of appearing on the icon bar.

Using applications

Once you have started an application, you can usually begin using it by clicking on its icon on the icon bar. An application window will open on the desktop.

For example, to use Edit, click on its icon on the icon bar: an empty Edit window will appear, ready for you to start writing.

Type in some text. Any text you type using the keyboard appears in the window. Text appears to the left of the vertical bar — the caret. The caret moves to the right, to make room for the text.

Press Return to start a new line, and press it again to leave a blank line.

Once you have typed a few lines of text, move the caret around the text by moving the pointer with the mouse and clicking Select — the caret will jump to the position of the pointer. You can insert (or delete) text at the new position.

If you aren't sure what the different keys on the keyboard are for, refer to Using the keyboard on page 39. A couple of points to note:

- The CapsLock key light may be on when you start, indicating that all letters you type will be capitals. Press CapsLock to turn the light off and get all lower-case letters.
- When the CapsLock is off, hold down Shift to type an upper-case letter (or one of the upper characters on the number keys).

After you've finished using an application, you will need to *save* any work you've done in a *file* on a disc (otherwise your work will be lost when you switch the computer off). The next chapter, *Files and directories*, tells you how to save the Edit file you've just created, so you can leave its window on the screen for now.

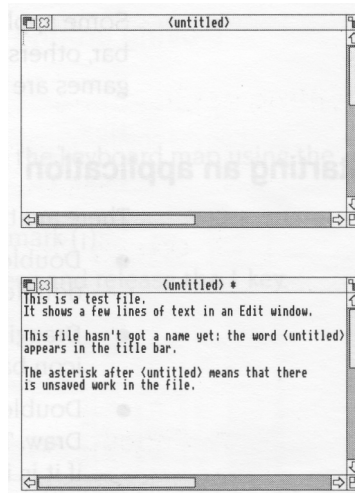

Using more than one application window

Often you'll have more than one application window open on the desktop (this is the power of RISC OS — it lets you transfer data between different windows and applications). You can only enter information (e.g. write some text, or draw a picture) in one window at a time. To change the window you are working in, click on an object or some text in your chosen window. You'll notice that the title bar and other window icons will change to a lighter shade, indicating that the *input focus* is now in that window.

For example, click on Edit's icon on the icon bar to bring up a second Edit window. The input focus will be in the second window.

Now click on some text in the first Edit window to change the input focus.

Close the second (empty) window. You don't need it now.

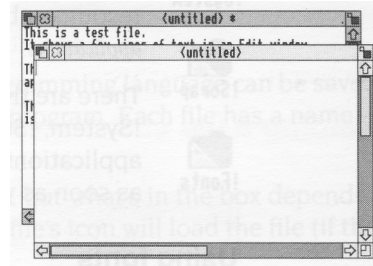

Quitting applications

When you've finished using an application, you'll usually want to quit it. To quit an application:

1 Display the application's icon bar menu

Click Menu over the application's icon on the icon bar.

For example, try this on Edit's icon.

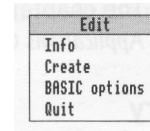

2 Choose Quit

Click on the **Quit** option.

If you've already saved everything you've done in the application, its icon will disappear from the icon bar.

If you've forgotten to save any work, the computer will remind you, and ask if you really want to quit, discarding any changes.

*In this case, you have not yet saved your work in Edit. So, click on **Cancel** to leave Edit running. You'll find out how to save your work in the next chapter.*

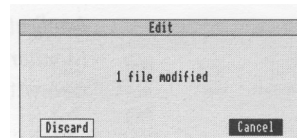

Getting the most out of applications

These are some tips to help you use applications efficiently. They're not essential reading now, and indeed they'll mean more to you after you've read the next chapter, so by all means come back to them later.

System applications



If you were writing a letter by hand, you would need to know where to find the *resources* to write it (paper, envelope, pen etc). The computer uses different types of resources, but also needs to know where to find them. They are contained in system *applications*.



There are three system applications the computer needs to be able to find: !System, !Scrap and !Fonts. On computers fitted with a hard disc, these system applications are supplied in the *root directory* (\$), so that the computer will see them as soon as you access the hard disc.



Using fonts



There are some *fonts* already in the computer's memory, and some extra ones in the !Fonts system application. Bring up a directory display containing !Fonts before you start any applications that use fonts (like a desktop publishing package). If you buy any more fonts from your supplier, you'll need to copy them into your existing !Fonts application.

The chapters entitled *Fonts* and *System applications* in the *RISC OS 3 User and Applications Guide* tell you more about this.

Memory

Appendix B: Getting the best out of 1MB computers in the *RISC OS 3 User and Applications Guide* gives you some hints on how to get the most out of the memory available on your machine (they are valid even if you have more than 1MB). For instance:

- Always quit applications if you're not using them — they take up memory. A good way to make sure there is no memory 'tied up' by an application you've quit is to restart the computer — see *Switching off the computer* on page 61.
- Choose a screen mode that doesn't use much memory. The *RISC OS 3 User and Applications Guide* tells you how much memory each screen mode uses. *MonitorType and screen modes* on page 78 tells you which screen modes you can use with your monitor.

Files and directories

This chapter explains how you can store information in an organised way, copy it, and delete it when you no longer need it.

Files and directories

Everything you create using an application or programming language can be saved as a file, whether it consists of text, graphics or a program. Each file has a name –you have to provide one when you save a new file.

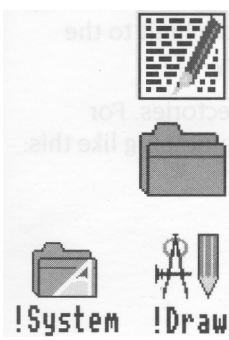

File icons usually have a square box around them, but what's in the box depends on what sort of file they are. Double-clicking on a file's icon will load the file (if the application to display it is available).

Files are stored in *directories*. A directory can contain many files, and also other directories (*subdirectories*) and applications. Directory icons usually look like folders, to indicate that they can contain files or other directories.

There is a special sort of directory called an *application directory*. Its name always begins with a '!', and it contains an application program, such as a word processor, or a drawing package. There is more about applications in the previous chapter and in the RISC OS 3 *User and Applications Guide*.

Opening directory displays

1 Open a directory display

For example, double-click on the App2 directory.

The resulting directory display shows various icons, including a directory called Tunes.

2 Open a subdirectory

Double-click on Tunes, and the Tunes directory display will appear. This contains files (in this case, a few tunes you can play using the Maestro application).

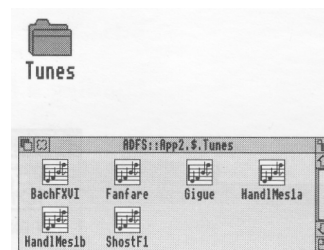

Double-clicking on an **application** directory loads the application, usually onto the icon bar ready for use. See the previous chapter for more on this.

Three refinements you might find useful later on:

- Double-clicking Adjust on a sub-directory icon opens the sub-directory display and simultaneously closes the directory display it came from (the *parent*). This reduces the number of windows on the desktop.
- Double-clicking Adjust on an application icon will simultaneously load the application and close its directory display.
- Clicking Adjust on the close icon closes a directory display and simultaneously opens its parent directory.

Building a file structure

You need to organise your files carefully. If you leave them all in the main directory on the disc, it will soon become large and unwieldy. There is also a limit to the number of files and directories you can have in an ADFS directory – 77.

Build up a file structure with files of similar types grouped in directories. For instance, the file structure of a disc for a newsletter might look something like this:

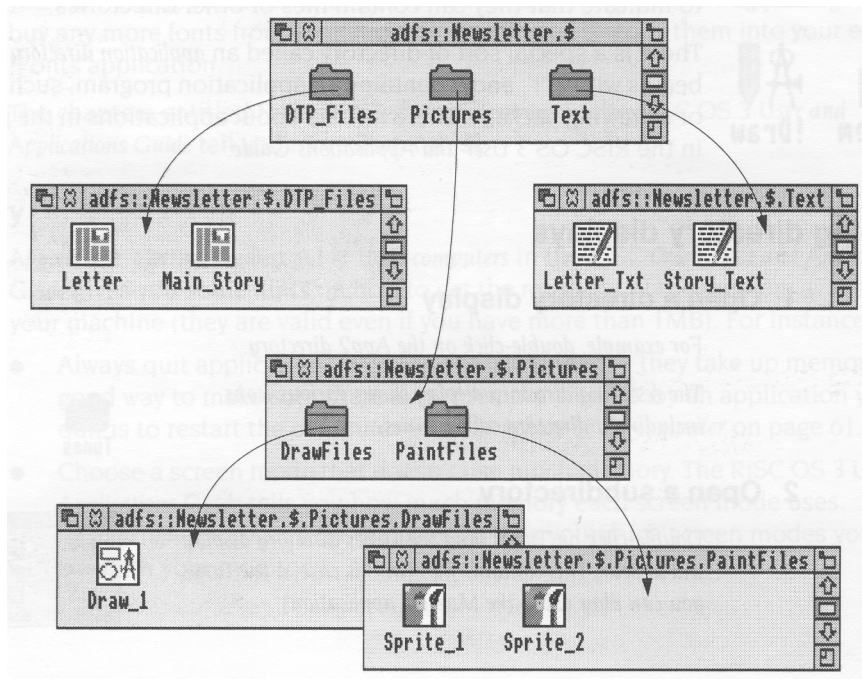

To create a structure like this, you'll need to create directories, and save, copy or move files into them.

To practise saving files, you'll need a work disc of your own. Create one by taking a new disc and formatting it, as described in *Formatting a floppy disc* on page 34. Give it the name **WorkDisc. Make sure the disc isn't write-protected, or you won't be able to save files on it.**

A fuller description of the filing system is given in the *RISC OS 3 User and Applications Guide*, in the chapter entitled *Discs, networks and filing systems*.

Creating a new directory

1 Open a directory display

Decide where you want to create the new directory, and open a directory display.

For example, with your work disc in the floppy disc drive, click on the floppy disc icon on the icon bar.

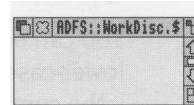

2 Enter a name for your new directory

Move the pointer over the directory display, click Menu to display the Filer menu.

Type in a name for your new directory in the **New directory/Name:** writable menu box and click on it (or press Return).

Call it `TestFiles1`, for example.

An icon for the new directory will appear in the directory display.

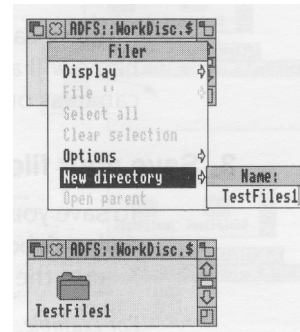

Saving (and loading) a file

1 Open the directory display

Decide on the directory in which you want to save your file, and double-click on its icon to open a display for it.

For example, double-click on the `TestFiles1` directory you've just created.

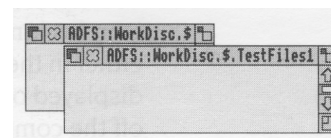

2 Give your file a name

Move the pointer over the work you want to save and press Menu to display the application menu. Enter a name in the **Save as:** dialogue box.

For example, try this on the Edit file you created in the last chapter.

*Click Menu and enter the name EditTest in the **Save/Save as:** dialogue box (you'll need to erase the default name TextFile using Delete).*

Filenames and directory names can have between one and ten characters, but **not** blank spaces or the characters \$ & % @ \ ^ : . # * " |.

You can use upper-case (capitals) and lower-case letters wherever you like in the name – the computer makes no distinction between them. The only reason for calling your file EditTest instead of edittest is that it's easier for you to read.

If you've saved this file before (the correct file name will appear on the box if you have) you can miss out the next step – just press Return.

3 Save your file

To save your file, drag the file icon in the dialogue box into the directory window and release the Select button.

For example, save your file EditTest in your TestFiles1 directory. Then quit the file EditTest (click on the Close icon).

Loading a file

You can **load** a file by double-clicking on its icon (as long as the relevant application is either in the Apps directory, or its icon has been displayed on the screen since you last switched off the computer).

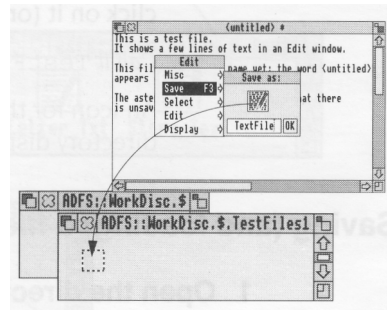
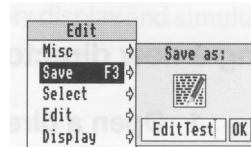
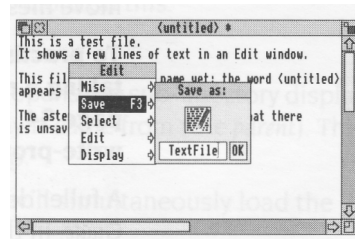

Copying (and moving) a file to another directory

1 Open the destination directory display

If you haven't already done it, open the directory you want to copy the file into.

*For example, create another new directory, on your disc WorkDisc, called TestFiles2 (follow the instructions in *Creating a new directory* on page 49). Open the new directory, so both TestFiles1 and TestFiles2 are displayed.*

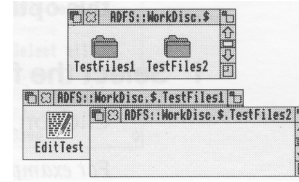

2 Select the file to be copied

Click on the icon of the file you want to copy.

You can select two or more files in the same directory display by clicking on their icons with Adjust (or by choosing **Select all** from the menu). Use Adjust to deselect icons, too.

3 Copy the file to the new directory

Drag the file's icon into the new directory display.

For example, drag the file EditTest onto the directory TestFiles2.

The file will be copied into the new directory. A copy of the icon will appear in the directory display when this has been done.

Moving a file

To *move* a file (so that the original is not retained in its original location), hold down Shift during steps 2 and 3 above.

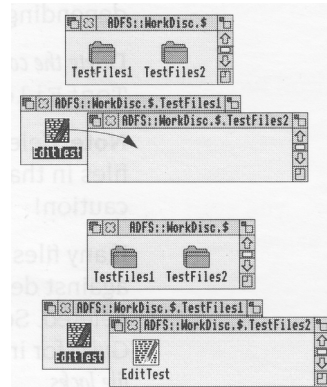

Deleting files and directories

Warning: once you have deleted a file or directory, you can't get it back again, so use this option with caution!

1 Select the file or directory to be deleted

Click on the icon of the file you want to delete.

For example, select the copy of EditTest in directory TestFiles2.

(You can select multiple files by clicking on their icons with Adjust, or by choosing **Select all** from the Filer menu.)

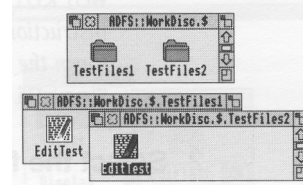

2 Delete the file or directory

Click Menu to display the Filer menu and choose the **File/Delete** option (this might be **App.**, **Dir.** or **Selection** instead of **File**, depending on what you've selected).

Delete the copy of file EditTest from the TestFiles2 directory.

Note: deleting a directory also deletes all the files in that directory, so use this option with caution!

If any files (or directories) have been *locked* against deletion, they will not, in fact, be deleted. See the RISC OS 3 *User and Applications Guide* for information on *file access* and removing *file locks*.

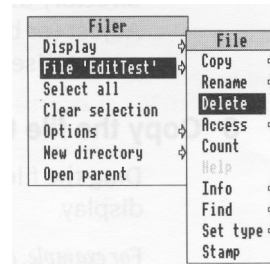

Pinboard

If you click Menu over a blank area of the desktop, you will see a menu called **Pinboard**.

Don't worry too much about this at the moment. It's explained in the RISC OS 3 *User and Applications Guide*, and enables you to do things like

- changing the whole background of the desktop into a picture
- leaving file or application icons 'stuck' to the desktop background, so you can see and use them, even when the directory they came from is closed
- closing a window down to an icon on the background.

You might come across one use of Pinboard when you are dragging files (for example) from one directory to another. If you let go of the Select button accidentally while the file you are dragging is over a blank portion of the desktop, its icon will stay on the background.

You can remove the 'dropped' icon from the background as follows:

1 Display the Pinboard menu

Move the pointer over the dropped icon and click Menu.

2 Remove the icon

Choose **Remove icon** from the menu. If that option is greyed out, it means that the pointer wasn't quite over the icon when you clicked Menu. Try again.

This action does **not** delete the file itself — the icon stuck on the pinboard is merely a 'pointer' to the real file on your disc.

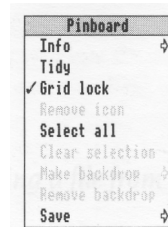

Printing

This chapter gives you an introduction to printing a file from your computer. It uses an Acorn JP-150 printer as an example.

Once you've used an application to produce some work, you'll probably want to print out what you've done. This chapter takes you through each stage involved in printing a file, from setting up the computer to producing a printed page.

This chapter assumes that you have already:



- Connected your printer to the computer (using the parallel port, in the case of the Acorn JP-150) using the correct cable (see *Setting up the computer* on page 3 and *Appendix C: Attaching peripheral devices* on page 79).

Note: Printer cables longer than about 5m can cause problems, with any computer.

- Set any options on the printer itself (check in the manual supplied with the printer whether you need to change any settings).
- Switched the printer and computer on. If you haven't, you can find out how to do this in *Switching on* on page 7.
- Put some paper in the printer.

Follow the instructions in this chapter carefully, and you shouldn't have any trouble printing your work. If you do get into difficulties, see *Problems with printing* on page 60 or check with your supplier.

Setting up

Before you can print anything, you need to make sure that the computer knows what sort of printer it is connected to. These are the steps involved:

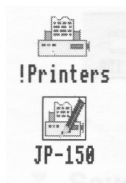

- Loading the *printer manager*, !Printers. This is an application which controls the printing process.
- Loading a suitable *printer definition*. This is a program which tells the computer what type of printer you're using.
- Setting the correct Configure and Connection options using !Printers.
- Activating the printer (though this is not always necessary).
- Saving the printer options.

The following pages take you through this setting-up process in detail.

1 Make a copy of !Printers

Open the App1 directory display. Copy ! Printers to your root directory. Use the copy, not the original so that you always have an unchanged version you can fall back on.

2 Load !Printers

Load !Printers by double-clicking on its icon. After a few seconds its icon will appear on the lefthand side of the icon bar, ready to use.

Click Menu on the icon bar icon and choose **Printer control....** This will display the Printer control window. You'll use this in the next step.

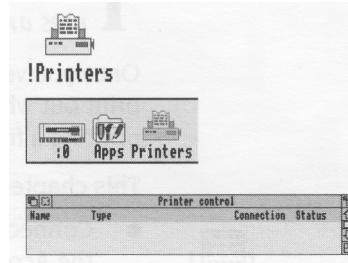

3 Load a printer definition

Open the directory called Printers in the App2 directory display.

Open the subdirectory which corresponds to the make of your printer (*for example, Acorn*).

You'll then see a directory display containing all the available printer definitions.

Decide which printer definition suits your printer. Load it by dragging its icon into the Printer control window. (If you can't see a printer definition that matches your printer, see *Problems with printing* on page 60).

For example, load the definition called JP-150, which is specifically for the Acorn JP-150 printer.

The Printer control window will change to include details of the printer definition you've just loaded, and so will the icon on the icon bar.

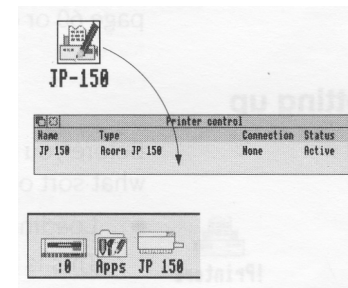

4 Set the Configure options

Click on the printer's name in the Printer control window (this will highlight it) then click Menu. This will display the Printers menu.



Choose **Configure...** to display the configuration dialogue box.

Change any settings that aren't correct (refer to the manual supplied with your printer).

*The only options you'll need to worry about for now in this window are **Resolution, Paper feed... and Quality.***

*For example, you can set **Paper feed...** to **Manual** or **Auto**. If you need to change it, click on the arrow to the right of the box and choose from the **Paper feed** menu that appears (the manual for your printer will tell you which type it uses.)*

When you're satisfied, click on **OK**.

(Experiment with the other options when you want a better quality print of your work.)

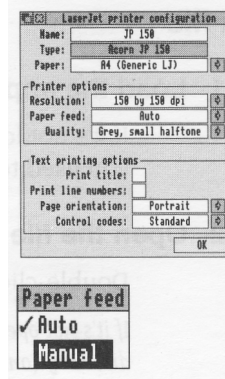

5 Set the Connection options

Click Menu on the printer name in the Printer control window to display the Printers menu again. This time choose **Connection....** You'll see the Connections window displayed.

Click on the button to the left of the connector that your printer uses.

*In the case of the 1P-150, choose **Parallel**.*

Click on **OK**. The details in the Printer control window will change to reflect your choice.

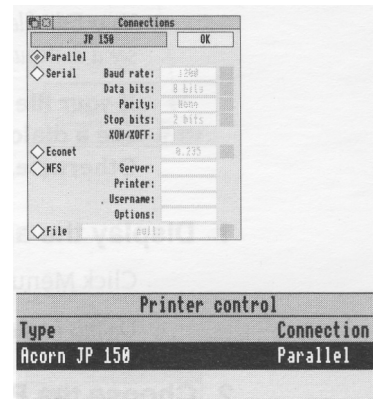

6 Activate the printer (if necessary)

Choose **Active** from the Printers menu (you'll only need to do this if you drag **more** than one printer definition onto the Printer control window — the first printer is set to active by default).

7 Save the settings

It's a good idea to save the settings you've just made. See *Saving printer configuration settings* on page 59.

Printing a file

1 Load the application

If it's not loaded already, load the application you used to create the file.

2 Open the file you want to print

Double-click on a file to open it.

If it's not open already, open the TestFiles1 directory (on your workdisc) that you created in the previous chapter. Open the file EditTest.



3 Press the Print key on the keyboard

Some applications (like Edit) will print a file straight away at this point (others will display a Print dialogue box – click on **OK** or **Print** to print one copy).

Your Edit file should print out fairly quickly – you won't see a dialogue box.

If your file doesn't print out, and you don't see a dialogue box, follow the next two steps. Otherwise, you can quit the file EditTest.

A typical Print dialogue box

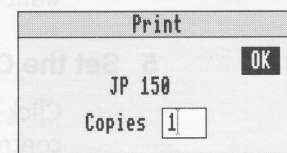

1 Display the application menu

Click Menu inside the file's window.

Do this in the window for EditTest.

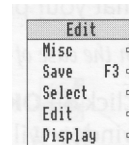

2 Choose the Print option

The **Print** option is not always in the top-level menu of an application. You may have to search through the submenus to find it.

Again, you might see a Print dialogue box, or your file might print straight away, depending on the application.

*In this case, choose **Misc/Print**. Your file should print out, but if things don't appear to be working, try some of the hints at the end of this chapter.*

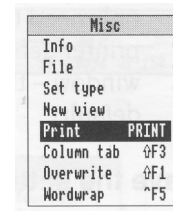

Another way of printing

You can often print a file by dragging its icon and dropping it on the printer's icon bar icon.

1 Load the application

If it's not loaded already, load the application you used to create the file.

2 Display the file's icon

Open the directory containing the file you want to print.

3 Print the file

Drag the file's icon over the printer icon on the icon bar and release the mouse button. Your file will print out.

Try this with the file EditTest.

Not all applications allow you to print this way, however. Check either in the *RISC OS 3 User and Applications Guide*, or the manual supplied with the application.

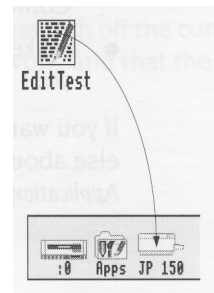

Saving printer configuration settings

It's worth saving the printer configuration so that you don't have to set it up every time you switch on the computer.

Click Menu over the printer icon on the icon bar and choose **Save choices**. Next time you load ! Printers it will automatically start up with this saved configuration.

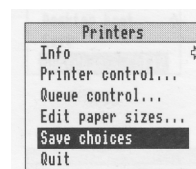

Problems with printing

The most common problems with printing occur in the setup stage. If your computer thinks it is connected to the wrong printer, you will have trouble. Take care with the following when you set up:

- Make sure that you're using the correct cable, and that it's not too long. You might get problems if the cable is longer than about 5m. This can sometimes cause spurious characters to be printed.
- Make sure you use the correct printer definition.

If there isn't one that matches your printer, you'll probably still be able to print – most printers have an Epson- or IBM-compatible mode. Check in the printer's manual if this is the case, and then choose one of the Epson or IBM printer definitions.

- Make sure that you have set the options correctly in the **Printers** menu and the Connections and Configuration windows.
- Make sure the printer is on line (not all printers have this option – check in your printer's manual) and hasn't run out of paper.

If you want to know what all the options in the **Printers** menu are for, or anything else about printing, see the chapter entitled *Printing in the RISC OS 3 User and Applications Guide*.

Switching off the computer

This chapter describes the correct procedure to follow before switching off your computer (do this at night, or if you're not intending to use the computer for a few days).

Normal shutdown procedure

When you've been doing some work on the computer and want to switch it off, you **can** simply switch off using the ON/OFF switch on the front of the computer. **However**, you'll lose any unsaved work this way.

By following the instructions in this chapter, you can switch off the computer more 'gracefully'. This will ensure that you don't lose any work, and that the computer is in a safe state before you turn off at the switch.

1 Save your work

Make sure that you save any work you have been doing, or you might lose it (see *Files and directories* on page 47).

2 Shut the computer down



Move the pointer over the Task manager icon (the Acorn) and click Menu.

Choose **Shutdown** from the menu.

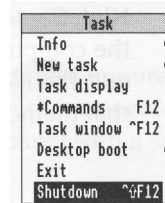

The computer checks to see whether you have left any work unsaved. If you have, a window will appear, asking you if you really want to quit the relevant application.

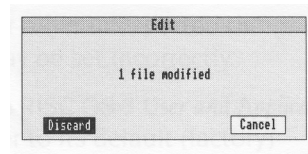

If you're sure you want to quit, click on **Discard** (to discard any changes). If you want to save your work before you switch off, click on **Cancel**, save the work, then choose **Shutdown** again.

The computer will perform any 'tidying-up' operations necessary, such as quitting any applications you've been using.

A window will appear when this has happened, telling you that the computer is ready to be switched off.

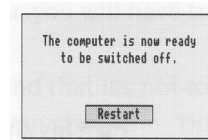

3 Switch off the computer and peripherals

Remove any floppy discs from the disc drive. Switch off the computer at the ON/OFF switch on the front.

Switch the monitor off (unless it was plugged into the power outlet on the back of the computer and switched off with the computer). If you have any other peripherals connected to your computer, check in the manuals supplied with them to see whether you need to switch them off every time you switch off the computer.

Note: When the window appears telling you shutdown has completed, you can restart the computer instead of switching off.

Click on **Restart** to do this, or hold down Ctrl and press Reset.

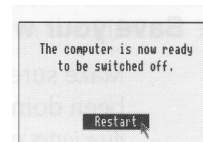

Hint: Some applications do not give up all of the computer's memory they've used when you quit them. This is a good way of 'reclaiming' that memory.

If things go wrong

This chapter offers solutions to some problems you might encounter while you are getting started with your computer. If none of these help, consult your supplier.

No picture

Check that

- the screen has not simply blanked as a result of the **Blank delay** set in !Configure (if this is the case, moving the mouse or pressing Shift will restore the display)The RISC OS 3 *User and Applications Guide* explains how to use !Configure
- the power supplies to computer and monitor are connected
- the monitor is connected to the computer, using the correct cable, the right way round
- the computer is turned on
- the monitor is turned on
- the brightness control on the monitor is not turned down

Flickering or flashing display

Check that the connectors between the monitor and the computer are tight. Switch off both the computer and the monitor, and push in the connectors firmly. Tighten the screws of the connector to the computer back panel with a small flat-bladed screwdriver.

Different screen display

If the computer starts up with a different display, or other unexpected things occur while you are using it, the system configuration may be set incorrectly.

See the chapter entitled *Resetting and power-on* in the RISC OS 3 *User and Applications Guide*, which tells you how to restore your computer to its default (factory) configuration.

Flashing floppy drive light

If the floppy drive indicator light flashes more than once when you switch on, and the computer doesn't power up properly (you can't see the RISC OS desktop after a few seconds) consult your supplier.

If the light only flashes once, this is normal. It should happen every time you switch on or reset the computer.

Pointer won't move

If moving the mouse does not move the pointer, check that

- the mouse is firmly connected to the keyboard and the keyboard to the computer
- the surface you are using the mouse on is firm enough to allow the mouse ball to move. Move the ball with your fingers to check that the mouse works.

You might need to clean the mouse ball. See *Cleaning the mouse* on page 67.

If all this fails, try holding down Ctrl and pressing RESET (on the lefthand side of the computer) to start the computer up again.

The pointer is not visible on the RISC OS desktop

If the pointer is not visible at all, check whether the command line (with ** prompt*) is at the bottom of the screen:

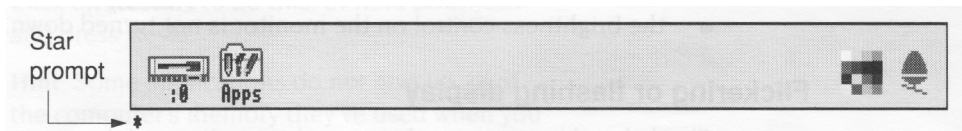

If it is, press Return to get back to the Desktop.

The computer powers up in Supervisor mode

If the computer powers up in Supervisor mode (the word *SUPERVISOR will appear at the top of a black screen) type Desktop at the prompt, then press Return. The section *Restoring default values* in *Appendix C: Resetting and power on* in the RISC OS 3 *User and Applications Guide* tells you how to make the computer start up with the desktop on the screen in future.

The desktop disappears

You have used the Exit option on the Task Manager menu and exited from the desktop completely. Type desktop and press the Return key. The desktop will return, but you will have lost any unsaved work. Alternatively, hold down Ctrl and press the Reset button (on the back of the keyboard) to bring back the desktop. Again, you will lose any unsaved work if you have to do this.

The computer 'forgets' its configuration

If the computer frequently forgets its configuration settings, or the clock consistently loses time, it may be that you haven't used the computer for a long time and the computer's internal CMOS RAM support battery may need recharging. Leave the computer switched on for a couple of hours, then try again.

If this doesn't cure the problem, the computer's internal CMOS RAM support battery may be faulty. Take the computer to your Acorn supplier, who will investigate.

The self-test does not complete properly

If you do not see a message *similar* to the following when the self-test is performed:

```
RISC OS 2048k  
Acorn ADFS
```

or if the self-test does not complete properly (the screen may stay red after you switch on, and the floppy drive indicator light may flash on and off a few times) then contact your supplier. There may be a fault with the computer's hardware.

Note: The number (indicating memory size) in the above message depends on what computer you have.

There are unexpected icons on an otherwise empty desktop

You might have dragged a file or application towards the icon bar, but accidentally let go too soon. See *Pinboard* on page 53

An application won't load

There may not be enough memory to load the application. Depending on how much memory your computer has, you will need to remove one or more of the applications that are already loaded into its memory. Move the pointer over an icon in the icon bar and press Menu; choose **Quit** to remove the application from the computer's memory. Now try loading the application you want to use. If there still isn't enough space, remove another application you don't need.

Appendix A: Maintaining your computer

This chapter tells you more about looking after your computer and its internal battery. It describes how to clean the computer and the mouse.

The internal battery

While it is switched off, the computer 'remembers' the time and other useful information such as its 'configuration' (features like how fast the pointer moves when you move the mouse). For more information on configuring your computer, see the RISC OS 3 User and Applications Guide.

To support this memory, the computer uses an internal battery which is charged while the computer is switched on. Ideally, to maintain the battery at full charge, the machine should be switched on for at least one hour in each five-day period. However, the battery does not need to be fully charged in order to work, and will in fact maintain the computer's clock and configuration for as long as six months while the computer is not being used. If your computer is switched off for this long, leave it on for a few hours the next time you use it.

In the course of time (after a few years) the battery, like a car battery, may run down. You can tell when this has happened by the fact that the computer will frequently 'forget' its configuration and the computer's clock will show the wrong time. You should then take the computer to your Acorn supplier, who will install a new battery.

Cleaning the computer, monitor and keyboard

First, remember to follow the *Guidelines for safe operation* at the very beginning of this guide. In particular, switch off and unplug the computer and any peripherals.

You can clean the computer case by wiping it gently with a soft, slightly damp cloth. Clean the keyboard with a clean, dry paintbrush. For advice on cleaning the monitor, refer to the manual accompanying it.

Cleaning the mouse

You should use the mouse on a surface that is as clean and as dust-free as possible. However, dust does sometimes get caught up in the ball on the underside of the mouse.

Cleaning the mouse

Clean the mouse occasionally to keep it running smoothly. To clean the mouse, you need the following items:

- some tape head cleaner
- a cotton swab
- a lint-free, dry cloth.

To remove the ball and clean the mouse, take the following steps:

- 1 Unplug the mouse and turn it upside down.
- 2 Unlock the ball retainer by twisting it in the direction of the arrows by a quarter of a turn (see the diagram below).
- 3 Hold one hand over the ball and retainer and turn the mouse right side up, allowing the ball and retainer to drop into your hand. Set them aside in a safe place.
- 4 Locate the three plastic rollers as shown in the drawing overleaf.
- 5 Lightly moisten the cotton swab with tape head cleaner and apply it gently to the rollers. Rotate the rollers, carefully cleaning off any dust or dirt that may be clinging to them.
- 6 Make sure the inside of the mouse is free from dust.

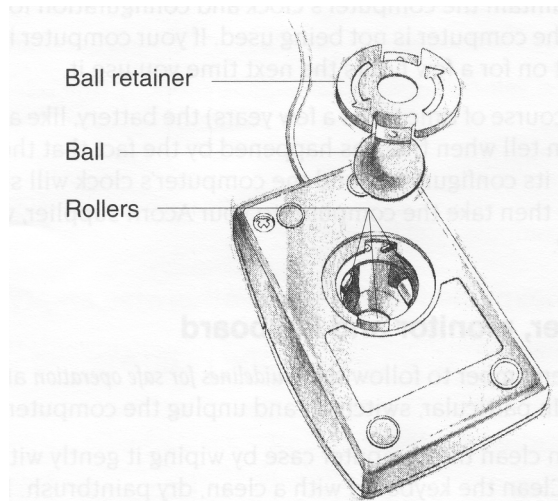

- 7 Wipe the ball with the clean, dry cloth. Do not use a cloth which may leave lint, and do not use cleaning liquid on the ball.

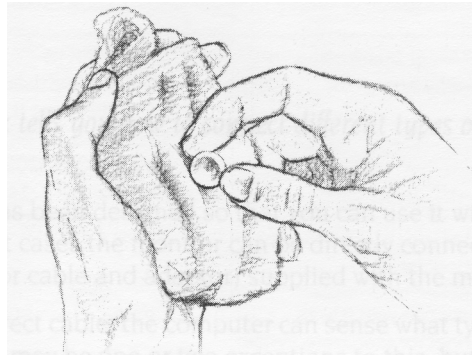

To replace the ball and retainer, take the following steps:

- 1 Turn the mouse upside down and place the ball back in the case.
- 2 Return the retainer to its original position (lock it in place by twisting it clockwise by a quarter of a turn).

Appendix B: Monitor connections

This appendix tells you how to connect different types of monitor to your computer.

Your computer has been designed so that you can use it with a wide variety of monitors. In most cases the monitor can be directly connected to the computer using the cable (or cable and adaptor) supplied with the monitor.

If you use the correct cable, the computer can sense what type of monitor you have connected. There may be one or two exceptions to this, but you should always get some sort of picture to start with.

What's involved

Take the following steps to get a picture on your monitor:

- 1 Use *Table 1: Monitor information* on page 72 and *Cables and adaptors* on page 73 to check
 - whether your monitor was supplied with the correct cable (if it wasn't, refer back to your supplier)
 - whether your monitor needs an adaptor, and the right one was supplied
 - the *MonitorType* best suited to your monitor.
- 2 If your monitor needs an adaptor that isn't supplied, ask your supplier to obtain one for you using the information in *Cables and adaptors* on page 73.
- 3 Connect the monitor to your computer, using the cable information gained from steps 1 and 2.
- 4 Follow the instructions in *Switching on* on page 7 to get a picture on your monitor.
- 5 If necessary, change the *MonitorType* to the number shown in *Table 1: Monitor information* (see *MonitorType and screen modes* on page 78 for instructions).

Table 1: Monitor information

Monitor family	Examples	Adaptor req'd
VGA [€] , or Multiscan with 15-way connector	Acorn AFK18 NEC Multisync 3D NEC Multisync II Taxan 795 Philips 3CM 3209 Panasonic TX-14H8BT	None* None* (supplied) None* None* None*
TV standard with 15-way connector	Acorn AKF40	None [¥]
Multiscan with 9-way connector (separate syncs)	Eizo Flexscan 9060	B
Multiscan with 9-way connector (composite syncs)	Taxan 770	C
TV standard with 9-way connector	Acorn AKF17	D
SCART TV or monitor with SCART connector	Acorn AKF12	E
Standard resolution mono	Philips BM7502 Philips BM 7442	F

[€]To allow only the VGA modes to be selected, set MonitorType to 3 (see *MonitorType and screen modes* on page 78) otherwise all the MonitorType I modes will be made available.

*No adaptor required. See *Cable type A* on page 73 for a typical pinout.

[¥]No adaptor required. See *Cable type G* on page 74 for a typical pinout.

Cables and adaptors

This section gives you the pinouts on standard cables supplied with monitors, and tells you how to make adaptors if they are required.

The pinout of the video connector on the back of the computer is illustrated in *Appendix D: Hardware components and connectors*.

Cable type A

This cable is supplied with most VGA and Multiscan monitors and is terminated at the computer end with a 15-way VGA style D-type plug.

The table below shows the typical pinout for the computer end of this type of cable. You can use this cable without modification.

Pin	VGA and Multiscan	Multiscan
1	Red	Red
2	Green	Green
3	Blue	Blue
4	Not Connected	0V (See note 1)
5	0V (or test)	0V (or test)
6	Red Rtn (0V)	Red Rtn (0V)
7	Green Rtn (0V)	Green Rtn (0V)
8	Blue Rtn (0V)	Blue Rtn (0V)
9	Not Connected	Not Connected
10	0V	0V
11	0V (See note 1)	0V (See note 1)
12	Not Connected	Not Connected
13	HSync	HSync
14	VSynC	VSynC
15	Not Connected	Not Connected

Note 1: Normally linked to pin 10 (0V) in the cable or in the monitor.

Note 2: NEC Multisync II monitors come supplied with a 9-way connector on the computer end of the cable, and an adaptor which allows you to connect this to the 15-way connector on the computer.

Multiscan monitors that have a 15-way connector are usually wired with the ID bits indicating either a VGA or SVGA monitor. In this case the system software will display a VGA mode 27.

Cable type G

This cable is supplied with TV standard monitors with a 15-way signal connector, such as the Acorn AKF40.

The table below shows the typical pinout for the computer end of this type of cable. You can use this cable without modification.

Pin	Acorn AKF40
1	Red
2	Green
3	Blue
4	ID(2) — No Connection
5	0 volts (test)
6	Red Rtn
7	Green Rtn
8	Blue Rtn
9	+5 volts
10	0 volts
11	ID(0) — No Connection
12	ID(1) — No Connection
13	HSync
14	Composite Sync
15	ID(3) — No Connection

Adaptor type B

The cable supplied with some Multiscan monitors is terminated at the computer end by a 9-way D-type plug. You need a 15-way plug to 9-way socket adaptor:

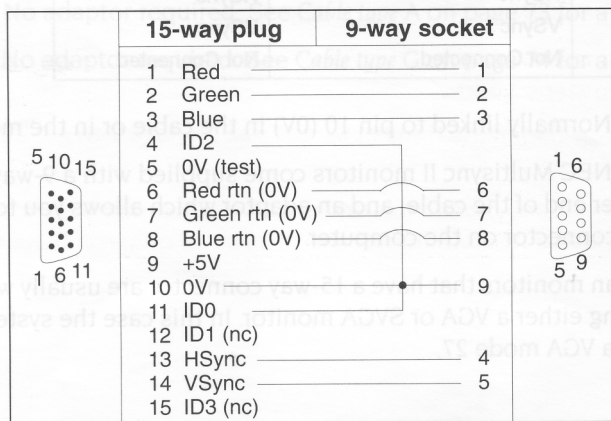

Most Multiscan monitors are now being designed to be VGA-compatible and will work satisfactorily when driven with separate horizontal and vertical sync signals.

Adaptor type C

The cable supplied with some Multiscan monitors requiring composite sync is terminated at the computer end with a 9 pin D-type plug. In this case you need a 15-way plug to 9-way socket adaptor:

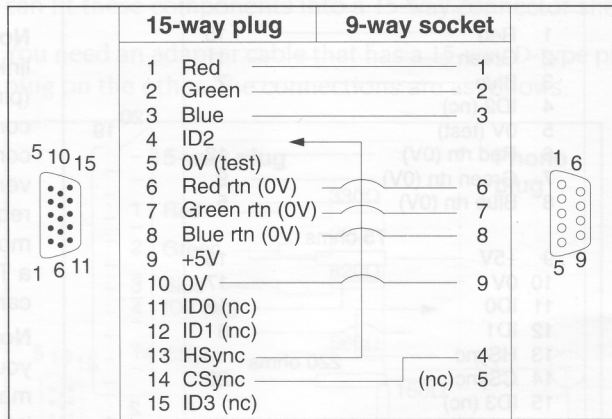

Note: HSync (pin 13) linked back into ID2 (pin 4) tells the computer that composite (rather than separate) sync is required, and that modes compatible with a Multiscan monitor can be displayed.

Adaptor type D

The cable supplied with some TV-type monitors is terminated at the computer end with a 9 pin D-type plug. You need a 15-way plug to 9-way socket adaptor:

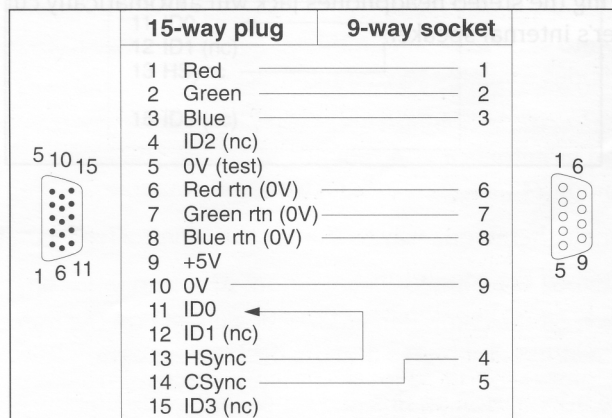

Note: HSync (pin 13) linked back into ID0 (pin 11) tells the computer that composite (rather than separate) sync is required, and that only modes compatible with a TV standard monitor can be displayed.

Cable type E

You need this cable (if it's not supplied) for use with televisions and monitors using a SCART input socket:

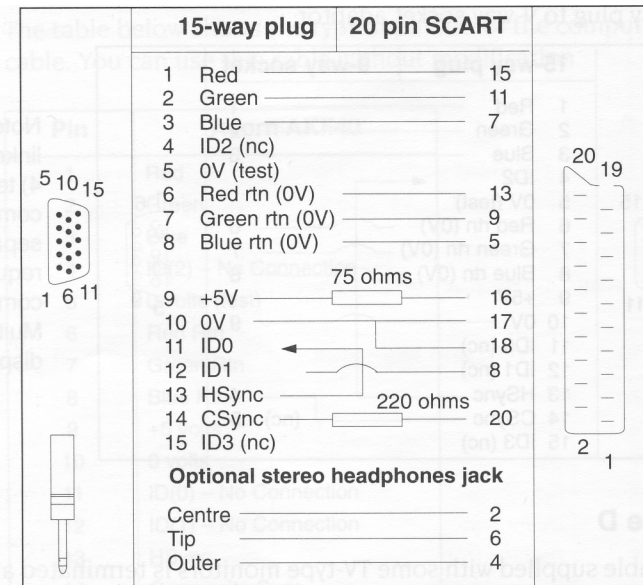

Note 1: HSync (pin 13) linked back to ID0 (pin 11) tells the computer that composite (rather than vertical) sync is required, and that only modes compatible with a TV standard monitor can be displayed.

Note 2: On some TVs you might have to manually switch the TV into SCART mode (check how to do this in the TV's manual).

Connecting the stereo headphones jack will automatically cut off the sound to the computer's internal speaker.

Cable type F

You need this cable to use with monochrome monitors which have a phono input socket. You need a 15-way plug to phono socket adaptor with resistors, to mix the separate red, green and blue signals into a composite monochrome signal (you can fit these components into a 15-way connector shell).

You need an adaptor cable that has a 15-way D-type plug on one end, and a phono plug on the other. The connections are as follows:

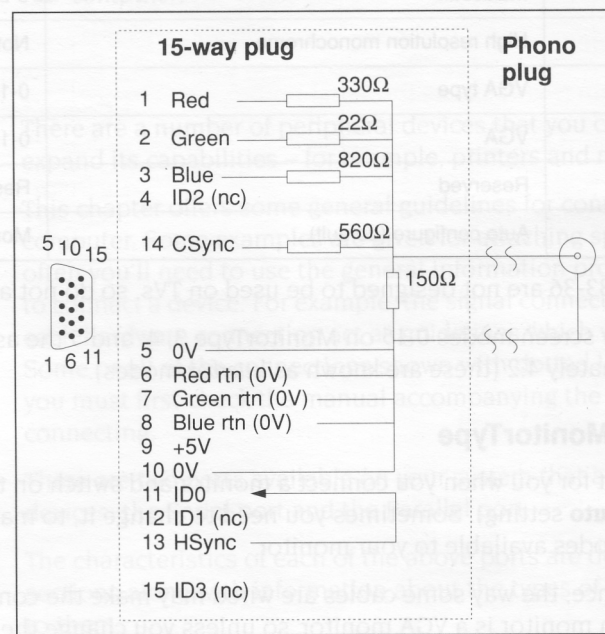

Note: HSync (pin 13) linked back into ID0 (pin 11) tells the computer that Composite sync (CSync) is required rather than VSync on pin 14 and that only modes compatible with a TV standard monitor can be displayed.

MonitorType and screen modes

MonitorType is a variable that controls which screen modes (see the RISC OS 3 *User and Applications Guide*) your computer can display. The following types are defined:

MonitorType	Description	Screen modes available
0	TV standard including SCART TV/UHF modulator	0-17, 24, 33-36
1	Multiscan	0-21, 24-31, 33-46
2	High resolution monochrome	Not supported
3	VGA type	0-15, 25-28, 41-46
4	VGA	0-15, 25-31, 41-46
5	Reserved	Reserved
Auto	Auto configure (default)	Monitor-dependant

*Modes 33-36 are not designed to be used on TVs, so do not adjust your set.

Note: For screen modes 0-15 on MonitorType 3, 4 and 5 the aspect ratio is approximately 4:2 (these are known as *letterbox* modes).

Changing the MonitorType

This is set for you when you connect a monitor and switch on the computer (the default **Auto** setting). Sometimes you need to change it, to make use of all the screen modes available to your monitor.

For instance, the way some cables are wired may make the computer think that a Multiscan monitor is a VGA monitor, so unless you change the MonitorType, screen mode 24 (amongst others) won't be available.

For example, here's one way to change the MonitorType variable to 1:

- 1 Switch off the computer.
- 2 Switch on the computer, holding down key 1 on the numeric keypad until the self-test has completed and the desktop appears.

For more information on this and other ways of setting the MonitorType, see the chapter entitled *Colours and screen modes* in the RISC OS 3 *User and Applications Guide*.

Changing the screen mode

To change screen mode, click Menu over the Palette icon and choose one of the **Modes** listed (or, type your chosen mode number at the bottom of the **Mode** box).

Using !Configure you can configure your computer so it always displays a particular screen mode. See the RISC OS 3 *User and Applications Guide*.

Appendix C: Attaching peripheral devices

This appendix gives you advice on attaching different peripheral devices to your computer.

Introduction

There are a number of peripheral devices that you can attach to your computer to expand its capabilities – for example, printers and modems.

This chapter offers some general guidelines for connecting peripherals to your computer. Some examples are given for attaching specific peripheral devices, but often you'll need to use the general information provided to help you decide how to connect a device. For example, the signal connection diagrams that are given for each hardware connection act as guidelines which will work with most hardware. Some or all of the connections shown with dotted lines may be unnecessary, and you must first check the manual accompanying the peripheral device that you are connecting.

There are two ports available on your system that are used to attach peripheral devices: the Serial port and the Parallel port.

The characteristics of each of the above ports are described in the following sections along with information about the types of devices that can be connected to them.

Serial port

The serial port is by far the most versatile and sometimes the most troublesome port to use. The port supports two different types of peripheral or equipment: Data Terminal Equipment (or DTE – for example printers and computers), and Data Circuit-terminating Equipment (or DCE– for example modems). It follows that you will need different cables, depending upon which type of peripheral (DTE or DCE) you are connecting to your machine. The computer itself is DTE.

When you connect peripherals to the serial port:

- Ensure that screened cabling is used to connect up the peripheral, and that the screening is connected to the shell of the connector.
- Consult the peripheral manufacturer's instructions for pin connections.

Printers on the serial port

Hardware connection

You should check carefully what options for flow control your printer uses, and if possible set it to XOFF/XON flow control. Some printers have alternative flow control mechanisms involving ETX/ACK (different control characters from XOFF/XON, transmitted under slightly different circumstances), or RTS/CTS (signals on additional wires on the interface cable).

An example

The diagram (right) shows the serial port signals used to connect to an Apple LaserWriter laser printer:

Software connection

For information on how to set up the software side of things, see Printing on page 55. You'll also find more information in *Printing in the RISC OS 3 User and Applications Guide*.

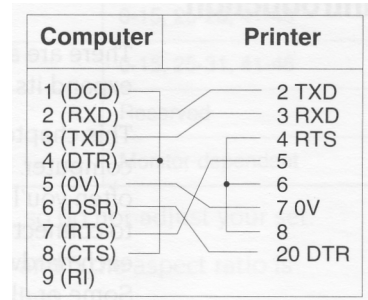

Modems on the serial port

A modem is usually connected up differently from a printer. This is because a modem is a DCE device; printers are DTE devices. The main difference is that the connections are 'straight through' — the modem expects to *receive* data on the 'transmitted data' line, and vice versa, whereas when connecting terminal to computer or computer to computer the connections have to be crossed over.

Hardware connection

You may need to ask your supplier for an adaptor cable to connect a modem or other standard RS232 DCE device. Here is the wiring guide for connecting to a standard RS232 25-way D-type connector:

In practice you may leave out RI and DSR. They are not often used. If the modem doesn't provide a CTS signal, leave it out and instead connect CTS to RTS at the computer end.

Computer	Modem
1 (DCD)	8 (DCD)
2 (RXD)	3 (RXD)
3 (TXD)	2 (TXD)
4 (DTR)	20 (DTR)
5 (0V)	7 (0V)
6 (DSR)	6 (DSR)
7 (RTS)	4 (RTS)
8 (CTS)	5 (CTS)
9 (RI)	22 (RI)

If you are connecting a different type of modem from the one illustrated, the differences will be in which signals the modem looks at and can supply. You can configure some modems to use or ignore the various control signals, by means of DIP switch settings or by sending commands.

Software connection

For information on how to set up the software, it's best if you check with your supplier, who will be able to tell you the communications package to use that best suits your modem.

Parallel port

The parallel port is commonly used to connect a printer, or to send/receive data to/from a device using eight data pins in parallel, making a byte of character data.

There is a diagram of the parallel port pinout in *Appendix D: Hardware components and connectors* on page 83.

Printers on the parallel port**Hardware connection**

You need a 25-way D-type connector to connect a parallel printer to the computer. Often, the cable supplied with your printer will be suitable. If not, the table overleaf gives an example of how the pins on the computer's parallel port map onto a 36-way Centronics-type Delta 57 connector.

The mapping is not one to one. The signals you need will depend on the type of printer, and the settings of any switches on the printer. As a general guide, most printers will work without the signals marked Optional.

In the first instance, ask your supplier to make sure they give you the correct cable. Check the printer's documentation for more information.

Computer	Printer
1 (STROBE)	1
2 (DATA0)	2
3 (DATA1)	3
4 (DATA2)	4
5 (DATA3)	5
6 (DATA4)	6
7 (DATA5)	7
8 (DATA6)	8
9 (DATA7)	9
10 (ACK)	10
11 (BUSY)	11
18 to 25	GND
	19 to 30
Optional	
12 (PE)	12
13 (SLCT)	13
14 (AUTO FD XT)	14
15 (ERROR)	32
16 (INIT)	31
17 (SLCT IN)	36

Software connection

Printing on page 55 tells you how to configure your computer to use a Acorn JP-I 50 printer. You'll find more information in Printing in the RISC OS 3 *User and Applications Guide* and the manual supplied with your printer.

Appendix D: Hardware components and connectors

This chapter describes the hardware components of the computer, and gives details about the connections of the different sockets.

The front of the computer

The drawing below shows the front of the computer.

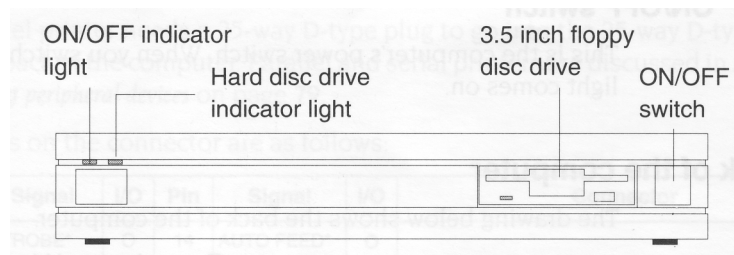

ON/OFF indicator light

This light comes on when you turn the computer on.

Hard disc drive indicator light

The indicator light comes on when the hard disc drive is being accessed by the system.

WARNING: When the hard disc drive indicator light is on, the computer is actually reading or writing data. Do not move the computer or turn it off while the light is on.

3.5 inch floppy disc drive

The floppy disc drive is located on the right. It includes a disc insertion slot, a drive indicator light, and a disc eject button:

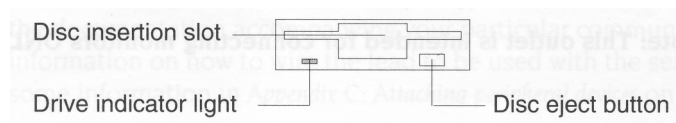

Drive indicator light

The indicator light comes on when the floppy disc drive is being accessed by the system.

WARNING: When the floppy disc drive indicator light is on, the computer is actually reading or writing data. Do not remove the floppy disc or turn off the computer while the light is on.

Disc eject button

The disc eject button releases the floppy disc so that you can remove it from the drive. When you press the button, the disc pops partially out of the slot, allowing you to remove it by hand.

ON/OFF switch

This is the computer's power switch. When you switch it on, the ON/OFF indicator light comes on.

The back of the computer

The drawing below shows the back of the computer.

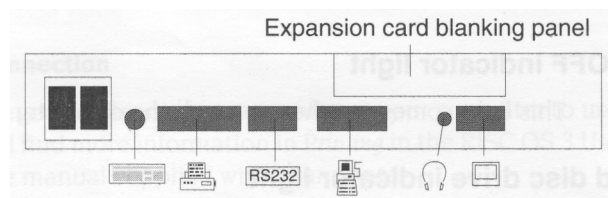

The following subsections describe the connectors on the back of the computer (an asterisk (*) after a signal name denotes active low).

Computer power connector

Use this three-pin connector to connect the computer to a standard power outlet.

Monitor power outlet

You can attach the power cable of most types of monitor to this outlet (check with your supplier). Its output is controlled by the ON/OFF switch on the front of the computer. The maximum continuous rating for this outlet is 1A @ 220V AC.

Note: This outlet is intended for connecting monitors **ONLY**.

Keyboard connector



The keyboard has a 6-way plug on the end of its cable, that goes into the 6-way socket on the back of the computer.

The pins on the socket are wired as follows:

Pin	Signal	Pin	Signal
1	RESET	2	No connection
3	0V	4	5V
5	Serial data in	6	Serial data out

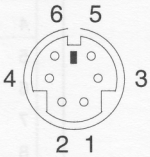

Parallel port



A parallel printer needs a 25-way D-type plug to go into the 25-way D-type socket on the back of the computer. Parallel and serial printers are discussed in *Appendix C: Attaching peripheral devices* on page 79.

The pins on the connector are as follows:

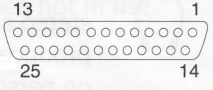
Pin	Signal	I/O	Pin	Signal	I/O	Connector
1	STROBE*	O	14	AUTO FEED*	O	
2	D0	I/O	15	ERROR*	I	
3	D1	I/O	16	INIT*	O	
4	D2	I/O	17	SELECT IN*	O	
5	D3	I/O	18	0V	N/A	
6	D4	I/O	19	0V	N/A	
7	D5	I/O	20	0V	N/A	
8	D6	I/O	21	0V	N/A	
9	D7	I/O	22	0V	N/A	
10	ACKNOWLEDGE*	I	23	0V	N/A	
11	BUSY	I	24	0V	N/A	
12	PAPER ERROR	I	25	0V	N/A	
13	SELECT	I				

Serial port



The serial port on the back of the computer is a 9-way D-type plug. A serial device to be connected here needs a 9-way D-type socket on the end of its lead. Refer to the documentation accompanying your particular communications package for information on how to wire the lead to be used with the serial port. There is also some information in *Appendix C: Attaching peripheral devices* on page 79.

The pins on the connector are as follows:

Pin	Signal	Connector
1	DCD I/P	
2	RXD I/P	
3	TXD O/P	
4	DTR O/P	
5	0V	
6	DSR I/P	
7	RTS O/P	
8	CTS I/P	
9	RI I/P	

Network interface connector



This requires an optional network interface expansion card to be fitted. This needs a 15-way D-type plug to go into the 15-way D-type socket on the back of the computer.

Use this socket to connect the computer with other Acorn computers on a local area network (LAN). A LAN allows you to communicate with several computers within a single geographic location. See your supplier for more information on the network interface expansion card.

Headphones



The headphones 32Ohm socket allows you to connect stereo headphones or your stereo amplifier system to the computer, through which you can hear sound produced by the computer. The lead must have a 3.5mm stereo jack plug (as used on personal stereos).

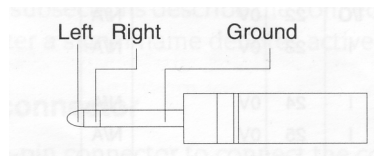

When you connect headphones to this socket, the computer's internal speaker is disabled.

Video



This 15-way D-type socket is used to connect your monitor to the computer (it is not suitable for TTL RGB monitors).

The pins on the socket are as follows:

Pin	Signal	Pin	Signal	Connector
1	RED	9	+5V	
2	GREEN	10	0V	
3	BLUE	11	ID<0>	
4	ID<2>	12	ID<1> I/P SCART	
5	TEST (0V)		function switching O/P	
6	R return (0V)	13	HSYNC	
7	G return (0V)	14	VSYNC/CSYNC	
8	B return (0V)	15	ID<3>	

See *Appendix B: Monitor connections* on page 71 for information on monitors that use this socket. See your supplier for information on the types of colour monitors that work with the computer.

Computer power cable

Use this to connect the computer to a standard power outlet.

Expansion card blanking panel

The blanking panel covers the expansion card slot when not in use.

Keyboard

The functions of the various keys are described in *Using the keyboard* on page 39. What follows here is a description of the back of the keyboard and how to connect it, and the mouse, to the computer.

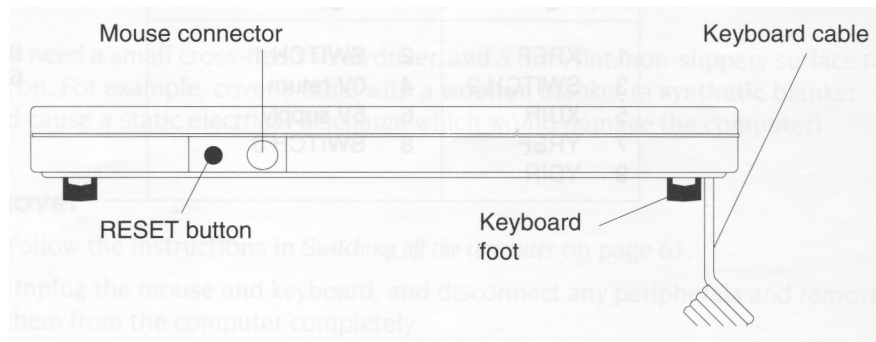

Keyboard feet

You can pull these down, making the keyboard slope more steeply if you wish.

RESET button

The RESET button is used to restart the computer without turning it off at the ON/OFF switch (press Ctrl RESET). Refer to the RISC OS 3 *User and Applications Guide*.

Warning: You'll lose any unsaved work when you do this.

Mouse connector

Use this 9-way connector to attach the mouse cable to the keyboard (the other end of the cable is permanently fixed to the mouse).

Keyboard cable

The coiled keyboard cable is permanently attached to the keyboard. It connects the keyboard to the computer. There are three gr00oves on the underside of the keyboard so that you can clip the cable to lead out from the right, left or centre of the keyboard.

Mouse

The mouse has a cable with a connector on the end which you plug into the 9-way connector on the back of the keyboard. Using *the mouse* on page 13 tells you how to use the mouse.

Mouse connector

The mouse has a 9-way mini-DIN plug that goes into the 9-way mini-DIN socket on the back of the keyboard. The pins on the socket are wired as follows:

Pin	Signal	Pin	Signal
1	XREF	2	SWITCH 1
3	SWITCH 2	4	0V return
5	XDIR	6	5V supply
7	YREF	8	SWITCH 3
9	YDIR		

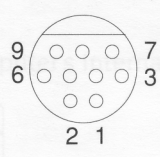

Appendix E: Inside the computer

This chapter tells you how to take the top cover off your computer prior to fitting any internal upgrades.

You can increase the power and versatility of your computer by fitting upgrades or expansion cards. Your supplier will know what upgrades are available. For example, you can expand your computer's memory by fitting extra RAM.

You should receive precise fitting instructions for upgrades or expansion cards when you buy them from your supplier. However, to be able to fit them, you first need to know how to remove the computer's cover and what to look for inside.

	<p>Before removing the top cover of the computer</p> <ol style="list-style-type: none">1 switch off the computer2 remove the power lead from the wall socket. <p>Do not reconnect the power lead to the wall socket until you have replaced the cover of the computer.</p> <p>Do not make any adjustments inside the computer while the power lead is connected to the wall socket.</p>
-----------------------------------------------------------------------------------	----------------------------------------------------------------------------------------------------------------------------------------------------------------------------------------------------------------------------------------------------------------------------------------------------------------------------------------------------------------------------------------------------------------

Acorn Computers Limited cannot accept any liability for damage done to the product during the installation of internal upgrades whether or not carried out in accordance with the instructions in this chapter. If you don't feel confident about carrying out any of the instructions in this chapter, ask your supplier to fit upgrades for you (a charge may be levied by the supplier for installing any upgrades; such a charge shall be entirely at the discretion of the supplier concerned).

Before you start

You'll need a small cross-head screwdriver, and a firm, flat, non-slippery surface to work on. For example, cover a table with a **woollen** blanket (a **synthetic** blanket could cause a static electrical discharge which would damage the computer).

Removing the top cover

- 1 Follow the instructions in *Switching off the computer* on page 61.
- 2 Unplug the mouse and keyboard, and disconnect any peripherals and remove them from the computer completely.

Reassembling the computer

- 3 Switch off the computer and disconnect it from the mains supply by unplugging the power supply cable from the wall socket.
- 4 Place the main unit on your work surface covered with the blanket, and turn it over so that it rests on its top cover.
- 5 Remove the two fixing screws on the underside of the main unit:

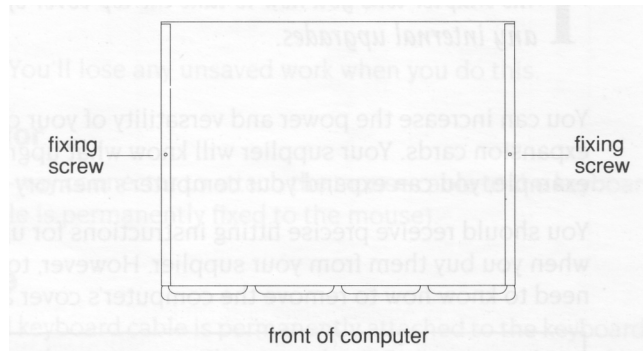

- 6 Rest the main unit on its base again and slide the cover backwards to the rear of the unit. Remove the cover completely:

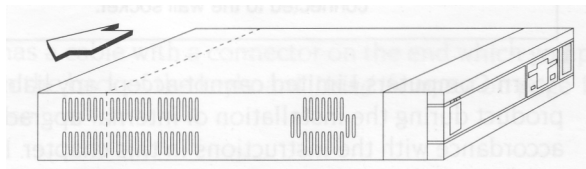

Reassembling the computer

Before reassembling the computer, make a final check that you have installed the upgrade in accordance with the instructions supplied with the upgrade.

Reassemble the computer using steps 4 to 6 above, but in the reverse order. Connect the computer together again following the procedure given in *Setting up the computer* on page 3.

Carry out any test procedures recommended in the instructions for the upgrade.

Glossary

This glossary defines any new terms that you may have come across in the guide. Terms in italics have their own definitions in this glossary.

adaptor — See *power adaptor*.

ADFS — Advanced **D**isc **F**iling **S**ystem (see the *RISC OS 3 User Guide* for more information).

adjust button — Righthand *mouse* button.



adjust size icon — *Icon* in the bottom righthand corner of some *windows*. Drag this to change the size of a window.

application — A program you use to perform tasks (such as word processing) or play games on the computer.

application directory — Similar to an ordinary *directory*, in that it contains other *files* or *directories*. Name starts with an exclamation mark (!). *Double-clicking* on an application directory starts the *application* (rather than just opening the directory).

application icon — Icon that appears on the *icon bar* when you start an application.



arrow icon — Icon that appears in a *dialogue box*. Click on it to increase or decrease numeric values.



Apps icon — An *icon* that is always present on the lefthand side of the *icon bar*. *Clicking* on this will give you access to the *applications* stored permanently in the computer's memory (ROM) such as Draw and Paint.

auto-start — You can configure the computer so that any or all of the ROM applications in the Apps directory will automatically start every time you switch on.



back icon — *Click* on this to send a *window* to the back of a pile of windows on the screen. Click on the *title bar* to bring it to the front again.

backup — A copy of an important *file* (or *directory*, or even a whole disc).

byte — A unit of storage, which consists of eight bits (ones or zeros) of information.

CapsLock key — Key at the bottom lefthand side of the *keyboard*. When the CapsLock light is ON, anything you type into the computer will be in upper case.

caret — A vertical bar in a *file* or *writable menu box*. Text you type in appears to the left of the caret.

clicking — Pressing and releasing one of the *mouse* buttons once (normally the Select button, unless otherwise stated).

clicking on — Pointing at with the mouse pointer and clicking Select.



close icon — Click *Select* on this to close a *window* or *directory display*. Click *Adjust* to close the window and simultaneously open its *parent*. Press *Shift* and click *Select* on this to close a window and leave its *icon* on the *Pinboard* (Double-click on the *Pinboard* icon to open it again). Press *Shift Adjust* to open the parent without closing the window.

computer control keys — These include the following keys: *Tab*, *Ctrl*, *Shift*, *CapsLock*, *Alt*, *Return*, the arrow keys, *Delete*, *Insert*, *Home*, *Copy*, *Page Up* and *Page Down*.

default — A standard setting or option, which the computer uses unless you tell it to do something else.

Delete key—The function of this key depends on what *application* you are using. For instance, in *Edit* (or a *writable menu box*) press this key to delete a character to the left of the *caret*. In *Draw*, press this key to delete a selected object.

desktop — Area of the screen display where you run *applications*, open *windows* and so on.

destination disc — When making a *backup*, you copy information **from** an original *source* disc **to** a blank, formatted destination disc.

devices and device icons — Devices really means storage devices – places where information (*files*, *directories* or programs) is kept. *Click* on the device icon (on the lefthand side of the *icon bar*) to see what is stored on the associated device.

dialogue box — A window in which you can set multiple options and supply file names in *writable menu options* before the computer performs a task or operation.

directory — Storage area – like a folder – in which you can keep *files* or *subdirectories*.

directory display — *Window* that displays the contents of a *directory* or storage *device*. *Double-click* on a directory to see its directory display.

disc — See *floppy disc*.

disc eject button — Make sure the *drive indicator light* is out before you press this to *eject* a *floppy disc*.

double-clicking — Pressing and releasing the *Select* or *Adjust* button twice in quick succession.



double-click arrow — When you double-click on an object, the *pointer* will change to a double-click arrow just after the first click. You have to make the second click before the pointer reverts to its normal shape.

double density floppy discs — Floppy discs capable of holding about 800KB of information when formatted.

drag — Press and hold down the *Select* or *Adjust* button and move the *mouse*, whilst the *pointer* is over the object you want to drag.

drive indicator light — This is an LED that lights when the disc drive is being used by the computer.



Econet — This is a means of connecting two or more computers together so that they can communicate with each other and share information. It is a type of Local Area Network (LAN) produced by Acorn. Contact your supplier for details.

eject — Press the *disc eject button* to eject a *floppy disc*.

Ethernet — Another type of LAN, developed by Xerox Corporation.

expansion card — An extra circuit board fitted to your computer that will make it more versatile and powerful. Expansion cards are available from your supplier.

file — A collection of information bundled together and given a name to identify it. For instance, a letter written on a word processor, a program, a *palette* definition.

file access — Controls who else can look at or change any of your *files* if your computer is connected to a network (like *Econet* or *Ethernet*).

file locks — Prohibit other users on a network from looking at or changing your files, and prevent you from accidentally deleting files you have protected.

Filer menu — *Menu* displayed when you click *Menu* over a directory display.

filing system — (e.g. ADFS) — A logical and structured way of storing and manipulating *files*. See the RISC OS 3 User *Guide* for more information.

floppy disc — Removable disc for storing information. Your computer uses 3.5 inch floppy discs.



font -- A typeface that the computer uses (e.g. Homerton, Trinity). Some are permanently stored in the computer's ROM, and some are in !Fonts. You can buy extra fonts.

format — Formatting a disc prepares it to receive information from the computer.

function keys — Set of keys along the top of the keyboard. What they do depends on which *application* you are using.

hard disc — A storage device fitted permanently inside the computer. Can hold much more information than a *floppy disc*.

high density floppy disc — Floppy disc capable of holding 1600KB of information when formatted under ADFS (1440KB under MSDOS).

icon bar — Strip along the lower edge of the *desktop* showing *icons* for *devices* and *applications* currently accessible from the computer's memory.

icons — Small pictures representing *applications*, *devices*, *files*, *directories* and so on.

input focus — When the input focus is on a particular file's *window*, you can alter that file (type in text, add graphics etc). The title bar and other icons on the window will change colour.

keyboard — Built in or attached to computer by a curly cable. You use it to input information to the computer.

kilobyte (KB) — Unit of size relating to storage space in a computer. There are 210 (1024) *bytes* in a kilobyte. A formatted high density *floppy disc* can hold about 1600KB. A hard *disc* can hold much more.

LED — Light Emitting Diode.

letterbox — A type of *screen mode*, much wider than it is high.

local area network (LAN) — A general term for a network like Econet or Ethernet.

megabyte (MB) — There are 210 (1024) *kilobytes* in a megabyte.

memory — The computer's information storage areas (see also RAM). If you try to run too many applications at once, you may run out of computer memory and have to remove some of the applications you are not using.

menu — List of actions you can choose from to perform on (or within) *files, directories, applications* and so on.

Menu button — Middle *mouse* button. *Click* it to display a *menu*.

menu option — See *menu*.

modem — Short for Modulator-Demodulator. A device that allows the computer to send and receive electronic signals via a telephone.

monitor — Screen unit (like a TV set) used to display communications from the computer. Monitors can be colour or monochrome (black and white). Also known as a Visual Display Unit (VDU).

MonitorType — A computer variable that determines which *screen modes* your *monitor* can display.

mouse — Small plastic box with three buttons on top and a cable attaching it to the computer. Hold it in your right hand, if you're right handed. Moving it moves the pointer on the screen.

move — Press Shift while *dragging* a file to move (rather than just copy) a file from one *directory* to another.

numeric keypad — Group of keys on the righthand end of the *keyboard*. When the light on the NumLock key is on, the keys perform the functions marked on them. With NumLock off, they may behave differently, depending on the *application*.

operating system — Actions you tell the computer to perform via the *desktop* are translated by the operating system into instructions that the computer can understand.



option icon — Icon that appears in a *dialogue box*. Click on it to toggle (switch) an option on or off.

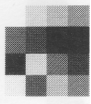

palette — Allows you to control the colours used to display different things on the *desktop*.

parent directory — A parent *directory* contains *subdirectories* and *files*. The files and subdirectories you see in a *directory display* are "children" of this parent directory.

peripheral — An item of hardware, e.g. a *printer, monitor* or *modem*).

Pinboard — *Application* that makes use of the blank areas of the *desktop*. You can *drag icons* onto the desktop itself and they will 'stick' there (still in the computer's memory, just not open on the desktop).



pointer — Arrow displayed on the *desktop*. It moves when you move the mouse. Use it to *move, change* or *select* items on the desktop.



pop-up menu icon — Icon that appears in a *dialogue box*. Click on it to display a submenu.

printer — *Peripheral* which prints *files* or documents onto paper.

printer definition — Program that converts *files* into information that your printer can understand and print.



printer manager — Application that oversees the printing process.

!Printers

prompt — Signifies that you need to type in a command or supply information (e.g. the * prompt that appears when you press F12).

quit — To close a *file* or *application*, and remove its *window* from the screen.



radio icon — One of a group of buttons that appears in a *dialogue box*, only one of which may be selected at once.



RAM — Random Access Memory – part of the computer information storage system which is accessible for storing or retrieving information without using *discs*. Information in RAM is lost when the computer is switched off.

resources — The means with which your computer runs programs and *applications*.

Return key — Key on the *keyboard* that you press to signify the end of an instruction to the computer (e.g. when you've finished typing in a *file* name in a *writable menu box*) or to start a new line in an Edit file.

RISC OS — Stands for: Reduced Instruction Set Computer Operating System. See also *operating system*.

ROM — Read Only Memory – similar to RAM, but ROM doesn't go away when you switch the computer off. The *operating system* and several applications and fonts are permanently present in ROM.

root directory (\$) — The top-level *directory* in a filing system (all other *files*, *subdirectories* etc are contained in it).

save — Keep a permanent copy of a *file* in its current state (including any changes made since the last save).

SCART — Type of connector used to connect some types of monitor or TV to the computer. Gives better picture and sound quality than using an ordinary coaxial aerial cable.

screen mode — Governs the physical appearance of the *desktop* on your *monitor*.

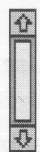

scroll arrows — Arrows at either end of the *scroll bars* of a *window* that is not large enough to show all of a *file*.

scroll bar — Shaded bar along the righthand (and sometimes lower) edge of a *window*.

scrolling — Moving around a large *file* using the *scroll bars* and *scroll arrows*.

Select button — Lefthand *mouse* button. Used to select items, choose *menu* options, *drag icons*.

self-tests — A series of tests performed by the computer when you switch on.

Shutdown — Menu option on the task *manager icon bar menu*. Choose this before you switch off the computer – it ensures that the computer shuts down 'gracefully'.

slider — Box within *scroll bar*. Drag it to move around a *file*.

source disc — See *destination disc*.

spindown delay — An option in the **Hard disc drives** window of !Configure.

storage device — See *devices*.

subdirectory — *Directory* in a *parent* directory.

submenu — *Menu* accessed by moving the *pointer* over an arrow on a main menu.

system application — Contains some of the *resources* that are common to all *applications*.



system disc — Floppy disc containing *system applications*.

Task manager — Icon on righthand side of *icon bar*. Use it to control how the computer uses its memory.

title bar — Area of a *window* in which the name of the *file*, *application* or *directory* appears.

toggle size icon — *Icon* in the top righthand corner of a *window*. *Clicking* on this toggles between full size and the last size at which a window was displayed.



toggling — Switching alternately between two states, usually by clicking *Select* (e.g. clicking repeatedly on the *Toggle size icon* of a window, or an option icon in a *dialogue box*).

track — An area defined on a disc when you *format* it, on which the computer stores data.

typewriter keys — Block of keys on the *keyboard* which resemble those on a typewriter.

window — Area of the screen designated for a particular activity or display – e.g. an *Edit window* (used to create a text file) or a *directory display*.

work disc — Floppy disc containing an application, *!Scrap* and a work directory.

writable menu option — A *submenu* option or part of a larger *dialogue box*. Either it already has a *caret* in it, or the *pointer* changes to a *caret* when it is over the option, indicating that you need to type in something (e.g. a file name).

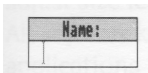

write-protect — To lock a *floppy disc* so that the information on it cannot be changed

Index

Symbols

- !Fonts 46
- !Maestro 9, 47
- !Scrap 46
- !System 46
- \$ (root directory) 46

A

- access 52
- accessing discs 32
- Adjust button 14
 - choosing a menu option 27
 - closing files and directories 48
 - opening files and directories 48
 - selecting and deselecting icons 51
- adjust size icon – *see* windows
- Alt key – *see* keyboard
- applications
 - application directories 47
 - Edit 43
 - hints and tips 46
 - loading 65
 - problems with 65
 - quitting 45, 61
 - resources 46
 - saving your work 44, 49
 - starting 43, 48
 - using 43-46
 - using from floppy discs 43
- Apps
 - directory 17, 18, 43
 - icon 17
- arrow icon 29

B

- back icon – *see* windows
- backup – *see* floppy discs and hard discs
- battery, internal 67

C

- CapsLock key 44
- CapsLock key – *see* keyboard
- caret
 - moving in Edit 44
- cleaning the computer, monitor and keyboard 67
- clicking 14, 15
- clock 67
- close icon – *see* windows
- closing files and directories with Adjust 48
- computer
 - cleaning 67
 - clock 67
 - configuration 67
 - diagram of rear panel 84
 - fitting upgrades 89
 - front panel diagram 83
 - ON/OFF switch 7
 - removing top cover 89
 - switching off 9
 - switching on 7
- computer control keys – *see* keyboard
- configuration 67
- connecting mouse and keyboard 3
- Copy key – *see* keyboard
- copying files 51
- copying text or objects 40
- creating a new directory 49

creating a work disc 49
Ctrl (control) key – *see* keyboard
Ctrl RESET
 restarting the computer 62, 64
Ctrl U
 deleting defaults in writable menu
 boxes 28, 35
cursor
 moving 40
cursor keys
 see keyboard

D
default
 definition 92
default names
 deleting with Ctrl U 28, 35
Delete key – *see* keyboard
deleting files 52
deleting text or objects 40
desktop 9, 11
destination disc 37
device icons 12
dialogue box 35
directories
 closing with Adjust 48
 creating 49
 icons 47
 opening 47
 restrictions on names 50
 subdirectories 47
disc eject button 32
disc format errors – *see* floppy discs
discs and disc drives 31-38
double density floppy discs 33
double-clicking 14, 15
 loading a file 50
 opening files and directories 47
 starting applications 43, 48
dragging 14, 16
 dragging windows off the screen 19

dropping icons on the desktop – *see*
 Pinboard
printing a file 59
saving a file 50
starting applications 43

E

Econet
 pinout 86
Edit
 printing an Edit file 58, 59
 starting 44
 using 44
efficient use of applications 46
expansion cards 87

F

file structure 48
Filer menu 49
files
 access 52
 application directory icons 47
 closing 48
 closing a file down to an icon on the
 background – *see* Pinboard
 closing with Adjust 48
 copying 51
 deleting 52
 icons 47
 loading and saving 49
 moving 51
 opening 47
 restrictions on filenames 50
 structure in a directory 48
files and directories
 max number allowed 48
 naming 49
filing system 49
fitting upgrades 89

flashing display – *see* troubleshooting

floppy discs 12, 31

backups 37

care of 32

creating a work disc 49

disc eject button 84

disc format errors 35

drive indicator light 84

floppy disc drive 31

formatting 34

inserting and ejecting 32

legal and illegal names 36

picture of disc drive 83

renaming 35, 36

storage size 33

write-protecting 33, 37

!Fonts 46

fonts 46

formatting – *see* floppy discs

function keys – *see* keyboard

G

getting the most out of applications 46

H

hard discs 12, 31

backing up important files 38

disc errors – what to do 38

drive indicator light 83

headphones 32Ohm socket 86

high density floppy discs 33

Home key – *see* keyboard

I

icon bar 11

bringing to the front 19

icons 11

directories 47

displaying large or small icons 27

files 47

selecting and deselecting 51

IEC 320 outlet 84

input focus

changing 45

inserting and ejecting floppy discs – *see* floppy discs

internal battery 67

J

JP-150

see printing

K

keyboard 39-41,87

Alt key 40

CapsLock key 39

computer control keys 40

connecting to computer 3

connector 85

Copy key 40

Ctrl (control) key 40

cursor keys 40

Delete key 40

features 87

function keys 39

Home key 41

mouse connector 88

moving the feet 88

multiple keystrokes 39

numeric keypad 39

Page down key 41

Page up key 41

RESET button 88

Return key 44

typewriter keys 39

typing special characters 42

using the keyboard 41

L

letterbox modes 78
loading
 applications 65
loading a file 49

M

!Maestro 9, 47
memory 65, 67, 94
memory allocation
 using the task manager 12
Menu button – see menus
menus 25-30
 applying to a file 26
 applying to more than one file 26
 cancelling 25
 choosing options 26, 30
 displaying menus 14
 displaying submenus 27
 Filer menu 26, 49
 greyed-out options 25
 icon bar menu 45
 Menu button 14, 26
 pop-up menu 29
 Select all option 26
 Shutdown option 61
 submenus 27
 using the Menu button 25
modems 79
 connecting to serial port 80
monitors
 connecting to computer 4
 switching on 7
MonitorType
 Auto setting 78
 setting 78
mouse 13
 buttons 14
 connecting to computer 3
 connector 88

 connector pinout 88
 holding 13
 moving the pointer 13
 techniques 14
moving files 51
multiple keystrokes – *see* keyboard
multitasking (working in more than one window) –
 see also input focus 45

N

naming files and directories 49
network interface expansion card 86
no picture 63
numeric keypad – *see* keyboard

O

ON/OFF indicator light 83, 84
ON/OFF switch 7, 84
opening files and directories 47
 using Adjust button 48
operating system
 RISC OS 11
option icon 28
organising files and directories 48

P

Page down key – *see* keyboard
Page up key – *see* keyboard
palette 12
 setting the screen mode 78
parallel port
 attaching peripherals 79
 hardware connection 81
 pinout 85
 printing 55
parent 48

peripherals
 adding 79
 connecting to computer 5, 79
 switching off 62

Pinboard 25
 dropping icons on the desktop 53
 iconising files 53
 problems 65

pointer 12

pop-up menu – see menus

power
 connecting to computer 4
 shutdown 61

printers 79
 connecting to computer 5, 79
 hardware connection on serial port 80
 hardware connection to the parallel port 81
 switching on 7

printing 55-60
 !Printers 55
 activating printers 57
 configuration settings 55, 56
 connections 55, 57
 getting started 55
 loading printer definitions 56
 Paper feed option 57
Print option 58
 Printer control window 56
 printer definitions 55
 printing a file 58, 59
 printing a file by dragging 59
 printing an Edit file 58, 59
 problems 60
 troubleshooting 60

problems with
 application 65

problems? 63

problem-solving ??-65

Q

quitting applications 45

R

radio icon 28

RAM (Random Access Memory) 95

removing top cover 89

renaming discs – *see* floppy discs

RESET button 64, 88

resizing windows – *see* windows

resources 46

restarting the computer 62

RISC OS 11
 desktop 9, 11

ROM (Read Only Memory) 96

root directory – *see* \$

S

safety standards v

saving files 50

saving work 44, 49

SCART
 connecting monitor or TV 72
 pinout of connector 76

screen modes 12, 78
 and memory usage 46
 setting with the palette 12, 78

scrolling – *see* windows

seeing what's on a hard or floppy disc – *see*
 accessing discs

Select button 14
 opening files and directories 47

selecting and deselecting icons 51

self-tests 8, 65

serial port
 attaching peripherals 79
 pinout 85
 printer connections 80

Shift F12
 bringing the icon bar to the front 19

Shift key
 typing upper-case letters 44

shuffling windows – *see* windows

shutdown 61
slider – *see* windows
source disc 37
special characters
 typing 42
starting applications – *see* applications
stereo headphones
 connecting to computer 86
structure – *see* files
subdirectories 47
submenus – *see* menus
switching off the computer 9
 shutdown procedure 61
switching on the computer 7
system applications 46

T

task manager
 memory allocation 12
 shutdown 61
title bar – *see* windows
toggle size icon – *see* windows
tools – *see* applications
troubleshooting 63
 printing 60
typewriter keys – *see* keyboard
typing special characters 42

U

unpacking the computer 1
upgrades
 fitting 89
using applications on floppy discs – *see*
 applications

W

where to put your computer 2
windows 17
 adjust size icon 18
 back icon 18
 close icon 18, 21
 closing with Adjust 48
 dragging off the screen 19
 manipulating 18-24
 obscuring the icon bar 19
 resizing 19
 scroll arrows 22
 scroll bars 22
 scrolling 21
 scrolling techniques 23-24
 shuffling 20
 slider 22
 title bar 18
 toggle size icon 18, 20
work disc 49
working with more than one window – *see* input
 focus
writable menu option 28
write-protecting – *see* floppy discs

Reader's Comment Form

Acorn A4000 (0494,650 issue 5)

We would greatly appreciate your comments about this Manual, which will be taken into account for the next issue:

Did you find the information you wanted?

Do you like the way the information is presented?

General comments:

If there is not enough room for your comments, please continue overleaf

How would you classify your experience with computers?

<input type="checkbox"/>	<input type="checkbox"/>	<input type="checkbox"/>	<input type="checkbox"/>
First-time user	Used computers before	Experienced user	Programmer

Cut out (or photocopy) and post to:
Dept RC, Technical Publications
Acorn Computers Limited
Acorn House,
Vision Park, Histon
Cambridge CB4 4AE

Your name and address:

This information will only be used to get in touch with you in case we wish to explore your comments further

