



Introducing The

C[®] Commodore[®]

AMIGA[®]

3000

Introducing The

 Commodore[®]

AMIGA[®]

3000

About this Book

This book introduces you to the Commodore® Amiga® 3000 computer. The book briefly describes the major components and features of the Amiga 3000 and tells how each works.

Please read this book and Chapter 1 of the Using the System Software manual included with your computer. You should then be ready to use programs like word processors, spreadsheets, etc. Of course you will also have to read the manual for each program you want to use.

The Amiga 3000 is a sophisticated, powerful machine. As you are using it you may find that you need or want additional information on its general operation and specific features. You can find detailed hardware information on the A3000 in this manual. You can find detailed software information in the Using the System Software manual.

NOTE: You can read this introductory book either before or after you unpack and set up your computer. HOWEVER, WHEN YOU DO SET UP YOUR COMPUTER BE SURE TO FOLLOW THE INSTRUCTIONS GIVEN IN THE AMIGA 3000 QUICK CONNECT.

Introducing the Commodore Amiga 3000, Rev 5 ***First Printing January 1991***

Copyright © 1990 by Commodore-Amiga Incorporated. All Rights Reserved. This document may not, in whole or in part, be copied, photocopied, reproduced, translated or reduced to any electronic medium or machine readable form without prior consent, in writing, from Commodore.

Commodore and the Commodore logo are registered trademarks of Commodore Electronics Limited. Amiga is a registered trademark of Commodore-Amiga. AmigaDOS, Auto-Config, A3000, Bridgeboard and Workbench are trademarks of Commodore-Amiga.

All other trademarks are the property of the respective trademark owners.

Nothing contained in this document shall give rise to warranties or guarantees, either expressed, or implied, with respect to the products described herein, their functionality, compatibility or availability. Further, Commodore assumes no responsibility or liability for statements or representations made by itself or by third party vendors or in the publications reproduced herein. IN NO EVENT WILL COMMODORE BE LIABLE FOR DIRECT, INDIRECT, INCIDENTAL, OR CONSEQUENTIAL DAMAGES RESULTING FROM ANY CLAIM ARISING OUT OF THE REPRESENTATIONS MADE HEREIN, EVEN IF IT HAS BEEN ADVISED OF THE POSSIBILITIES OF SUCH DAMAGES. SOME STATES DO NOT ALLOW THE EXCLUSION OR LIMITATION OF SUCH WARRANTIES OR DAMAGES, SO THE ABOVE EXCLUSION OR LIMITATIONS MAY NOT APPLY.

Information in this document is subject to change without notice and does not represent a commitment on the part of Commodore.

NOTICE: If this product is being acquired for or on behalf of the United States of America, its agencies and/or instrumentalities, it is provided with RESTRICTED RIGHTS, and all use, duplication, or disclosure with respect to the included software and documentation is subject to the restrictions set forth in the Rights in Technical Data and Computer Software clause at 252.227-7013 of the DOD FAR and the Rights in Data—General clause at 52.227-14 of the FAR. Unless otherwise indicated, the manufacturer/integrator is Commodore Business Machines, Inc., 1200 Wilson Drive, West Chester, PA 19380.

FCC USER'S MANUAL STATEMENT

WARNING:

This device complies with Part 15 of the FCC Rules. It also complies with Standard C108.8-M1983 of the Canadian Standards Association's Regulations. Operation is subject to two conditions: (1) This device may not cause harmful interference, and (2) this device must accept any interference received, including interference that may cause undesired operation. If this device does cause interference, correct it by doing any of the following:

- Reorient the receiving antenna or AC plug.
- Change the relative positions of the device and the receiver.
- Plug the device into a different outlet so the device and receiver are on different circuits.

CAUTION: Only equipment with shield-grounded cables (computer input-output devices, terminals, printers, etc.), certified to comply with appropriate FCC limits can be attached to this device. Operation with non-certified equipment may result in communications interference. Changes or modifications to this device not expressly approved by the party responsible for compliance could void the user's authority to operate the device.

Your house AC wall receptacle must be three-pronged type (AC ground). If it is not, contact an electrician to install the proper receptacle. If a multi-connector box is used to connect the computer and peripherals to AC, the ground must be common to all units.

If necessary, the user should consult the dealer or an experienced radio-television technician for additional suggestions. The user may find the following booklet helpful prepared by the Federal Communication Commission: "How to Identify and Resolve Radio-TV Interference Problems." This booklet is available from the U.S. Government Printing Office, Washington, D.C. 20402, stock no. 004-000-00345-4.

P/N: 363 303-05

92 93 2 3 4 1 2 3 4 O

Contents

ABOUT THIS BOOK

1. OVERVIEW OF THE AMIGA 3000	1-1
THE PARTS OF THE A3000 SYSTEM	1-3
THE A3000 DOCUMENTATION	1-8
2. FEATURES OF THE AMIGA 3000	2-1
HARDWARE FEATURES	2-1
68030 Microprocessor	2-1
68881/68882 Numeric Coprocessor	2-2
Hard Disk	2-2
Display Enhancer	2-2
SCSI Controller	2-3
STANDARD AMIGA FEATURES	2-3
Graphical User Interface (GUI) Processing	2-3
Command Line Processing	2-4
Multitasking	2-4
Text-to-Speech Conversion	2-4
Stereo Sound	2-4
AUTOCONFIG	2-5
GRAPHICS CAPABILITIES	2-5
FOR MORE INFORMATION...	2-7
3. GETTING STARTED	3-1
ABOUT SOFTWARE	3-1
ABOUT DISKS	3-2
Floppy Disks	3-3
Protecting Floppy Disk Information	3-3
Hard Disks	3-5
ABOUT THE MOUSE	3-5
TURNING ON THE A3000	3-7

BOOTING THE A3000	3-8
Booting from the Hard Disk Drive	3-8
Booting from the Floppy Disk Drive	3-8
WORKBENCH — THE AMIGA GRAPHICAL USER INTERFACE	3-9
THE WORKBENCH SCREEN	3-10
Moving the Pointer and Selecting	3-11
About Menus	3-12
Additional Workbench Features	3-13
BACKING UP YOUR ORIGINAL DISKS	3-14
LOADING PROGRAMS FROM A FLOPPY DISK	3-15
SAVING YOUR WORK	3-15
TURNING OFF THE A3000	3-16
THE A3000 HARD DISK	3-17
Copying Programs to the Hard Disk	3-18
Loading Programs from the Hard Disk	3-18
Saving/Retrieving Hard Disk Files	3-18
Backing up the Hard Disk	3-18
Contents of the Hard Disk	3-19
CARING FOR YOUR A3000	3-20
Cleaning the Mouse	3-21
Taking Care of Floppy Disks	3-23

4. EXPANDING THE AMIGA 3000	4-1
EXPANSION OPTIONS AVAILABLE	4-1
Using Expansion Slots	4-1
Memory Expansion on the Motherboard	4-3
CHIP RAM Expansion	4-3
Video Expansion	4-3
Adding Disk Drives	4-5
Adding SCSI Devices	4-5
PC Emulation with Bridgeboards	4-5
INSTALLING OPTIONS	4-6
Removing the A3000's Cover	4-6
Installing Expansion Cards	4-8
Installing Video Expansion Cards	4-9
Installing Hard and Floppy Disk Drives	4-10
Installing Random Access Memory (RAM) Chips	4-13
FAST Memory	4-14
CHIP Memory	4-18
Connecting Additional SCSI Devices	4-23
 APPENDICES	
A. TECHNICAL SPECIFICATIONS	A-1
B. INPUT/OUTPUT CONNECTOR PIN ASSIGNMENTS	B-1
C. USING THE DISPLAY ENHANCER	C-1
D. THE A3000 KEYBOARD	D-1
E. USING THE A3000 INSTALL DISK	E-1
F. A3000 SCHEMATICS	F-1
G. JUMPER SETTINGS	G-1

Chapter 1

Overview of the Amiga® 3000

The Amiga 3000 (also known as the A3000™) is an extremely advanced, high-speed personal computer. Incorporating all the unique features of earlier Amiga computers, the A3000 offers a high-speed microprocessor, a numeric coprocessor, and additional input and output features for significantly enhanced computing speed and versatility. The A3000 is remarkably sophisticated and powerful, yet it is also affordable and accessible — even a computer novice can be up and running with a minimum of effort.

The A3000 is shipped with two types of random access memory (RAM). This memory includes Fast RAM (memory available for basic computing functions, such as data processing), and Chip RAM (memory available primarily for tasks involving graphics and sound). The A3000 motherboard can accommodate up to a total of 18 MB of RAM on the motherboard. The amount of RAM in your machine depends on the model you have selected.

The A3000 can accommodate up to two megabytes of Chip RAM. This allows the A3000 to enhance the already impressive graphics and sound capabilities of earlier Amiga models.

The A3000 is an open-architecture machine. The A3000 internal expansion slots are upwardly compatible with Amiga 2000 expansion cards (like the Commodore *Bridgeboard*™ PC emulation cards), while offering increased performance for new devices developed specifically for the A3000. These expansion slots allow a wide variety of specialized circuit cards to be

quickly and easily installed in your A3000, adding networking capability, video processing, microprocessor enhancements, and other resources — all within the main chassis of the computer. Such cards, available from Commodore and from many third parties, increase the power of the A3000 without increasing its desktop footprint.

Many devices commonly considered add-on devices come standard with the A3000, saving you money and freeing up valuable expansion slots for other uses. For instance, included on the A3000 motherboard is a DMA SCSI controller for managing hard disks and other SCSI devices. The A3000 also has built-in *Display Enhancer* circuitry that can produce crisp screen output in selected graphics modes (this requires a multiscan-type monitor). This leaves the video expansion slot available for other video devices, such as an internal genlock or other graphics cards.

The new ECS (Enhanced Chip Set) circuitry supports two new video modes: the *Productivity* mode and the *Superhires* mode, available when using AmigaDOS 2.0. (These modes are described in the *Using the System Software* manual).

For the technical specifications and detailed technical information on the A3000, see the appendices to this manual.

The Parts of the A3000 System



- **The Main Unit** — Houses the 68030 CPU (central processing unit), the “brain” of the A3000. The main unit also contains:
 - *memory, processing chips, and specialized components, including:*
 - system RAM
 - 6888x numeric coprocessor
 - sound and graphics chips
 - Display Enhancer circuitry
 - DMA SCSI controller

- *disk drives*, including:
 - one hard drive
 - one floppy drive
 - space for a second drive (hard or floppy)
- *expansion slots*, for optional internal devices, such as:
 - expansion cards for memory, communications, etc.
 - PC emulation cards (Bridgeboards)
 - special video processing cards, etc.
- *external connectors*, for optional external peripheral equipment, such as:
 - printers
 - modems
 - disk drives
 - video equipment
 - audio equipment, etc.
- *power supply and fan*

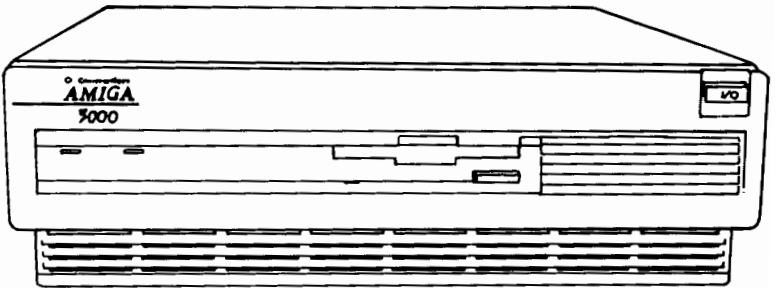

- **The Keyboard** — Provides a full typewriter-style layout, plus a standard numeric keypad and a set of program-activated function keys. The keyboard is used to communicate information and instructions to the computer, and to respond to messages from the computer. Many mouse functions (see below) can be performed via the keyboard. *The keyboard connects to the keyboard port on the right side of the main unit.*

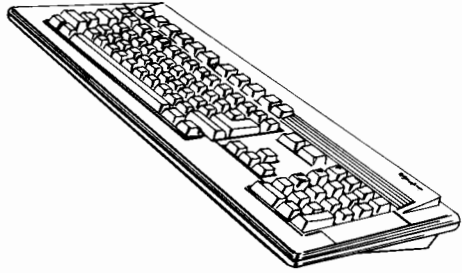

- **The Mouse** — Controls the movement of a small, arrow-shaped pointer on the display screen. When you move the mouse over a flat surface like a desk, the pointer on the screen moves accordingly. By clicking on the mouse buttons you can transmit instructions to the Amiga. *The mouse connects to the front mouse port on the right side of the main unit.*

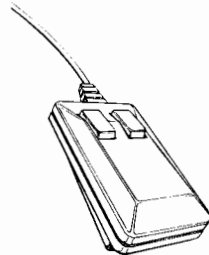

- **Floppy Disks** — A circular piece of magnetically coated material enclosed in a protective hard plastic housing. Floppy disks are used to store information and programs that tell the computer what to do. Amiga floppy disks are 3.5 inches across and can hold approximately 880,000 characters of information.

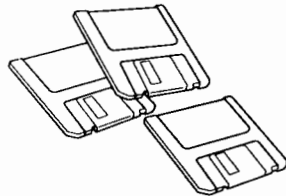

- **Floppy Disk Drive(s)** — When a floppy disk is inserted into the floppy disk drive, the computer can be instructed to obtain (*read*) information from the disk, or send (*write*) information to it. *The standard A3000 includes one floppy disk drive, located on the front of the main unit.*

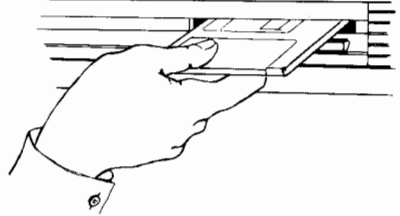

- **Monitor** — Displays information generated by the computer's operating system and your programs. The monitor may be one of several types, and may or may not be included as part of the Amiga 3000 package, depending on the country of purchase. *Depending on its type, the monitor connects to either the 15 or 23 pin video port on the back of the main unit.*



- **Hard Drive** — Stores very large amounts of information (many times more than a standard floppy disk). Hard drive capacities will vary, depending on which model of the A3000 you have purchased. *The standard A3000 hard drive is located inside the main unit.*
- **Built-In Clock/Calendar** — Maintains the time and date even when the computer is turned off, via a battery back-up. *The clock/calendar and battery back-up are located inside the main unit.*

- **Peripherals** — Internal and external peripherals (printers, modems, disk drives, Bridgeboard PC emulators, genlocks, etc.) can be added to your Amiga 3000 system. See the *Amiga 3000 Quick-Connect* for the basic external A3000 setup and connection instructions. See Chapter 4, *Expanding the Amiga 3000*, in this manual for information on internal expansion options (memory, expansion cards, etc.).

The A3000 Documentation

In addition to this manual, the A3000 package includes the following documentation:

- ***QUICK CONNECT—How to Set Up the Commodore Amiga 3000***

This is a 6-inch by 9-inch booklet that tells how and where to connect the A3000 equipment, including optional devices. The booklet folds out to become a large poster. You can hang the poster in a convenient spot while you follow the connection instructions.

- ***USING THE SYSTEM SOFTWARE***

This manual provides comprehensive information on the Amiga operating system. The manual includes detailed coverage of the Workbench, the basic user interface for the Amiga. The manual begins with a tutorial aimed at the new user. Subsequent sections build on this base, introducing advanced Workbench features.

This manual also documents AmigaDOS, the operating system that manages the Amiga's computing resources. The AmigaDOS material includes a chapter describing the AmigaDOS text editors, plus a reference section.

Chapter 2

Features of the Amiga 3000

Hardware Features

68030 Microprocessor

The central processing unit of the A3000 is a Motorola® 68030™ microprocessor, available with clock speeds of either 25 or 16 MHz. (Clock speed, given in MHz, is one measure of how fast a computer's microprocessor(s) can perform tasks.)

The Motorola 68030 microprocessor vastly increases processing speed over previous Motorola 68000™-class microprocessors in several important ways:

- It has full 32 bit architecture — that is, it reads and writes data in 32-bit blocks (compared with the 16-bit architecture of earlier Amiga models).
- Its cache memory allows faster performance, even with 16-bit memory.
- It works directly with the A3000's built-in Floating Point Unit (Motorola 68881™ or 68882™ numeric coprocessor) for very fast mathematical calculations.

Except for the difference in speed, the 16 MHz version of the A3000 has all the advanced features of the 25 MHz version.

68881/68882 Numeric Coprocessor

The A3000 is also equipped with either a Motorola 68881 or Motorola 68882 numeric coprocessor, running at a clock speed of 16 or 25 MHz, respectively (matching the clock speed of the 68030 CPU). The addition of a numeric coprocessor greatly increases the processing speed for numeric-intensive applications like graphics, spreadsheets and CAD programs.

Hard Disk

The A3000 comes with a built-in hard disk drive. The hard disk drive has a storage capacity equivalent to that of dozens of floppy disks. A hard disk drive stores and retrieves information much faster than a floppy disk drive.

For information on using the hard disk, refer to the *Using the System Software* manual, especially Chapter 6.

Display Enhancer

The A3000 includes special video display circuitry, known as the *Display Enhancer*, that offers improved display capabilities.

The action of the Display Enhancer is software-compatible with the function of many existing software packages and internal Amiga plug-in cards, as well as the new *Productivity* mode available with the new Enhanced Denise chip and AmigaDOS 2.0.

Refer to Appendix C for detailed information on the features and use of the Display Enhancer.

SCSI Controller

The A3000 has a built-in DMA SCSI (Small Computer System Interface) Controller that provides a link between the hard disk and the Amiga, allowing you to boot (start operations) directly from the hard drive. There is no need to insert a disk into the floppy disk drive to get the system up and running.

The A3000 has internal and external SCSI connectors for additional hard disks or other SCSI devices.

Standard Amiga Features

Following are brief descriptions of features that are included in all Amiga computers. For more details on these features, see the *Using the System Software* manual.

Graphical User Interface (GUI) Processing

A *Graphical User Interface (GUI)* allows you to tell the computer what to do by selecting graphic symbols (in the form of *icons*, or small pictures), rather than having to type in words or commands. Because the icons are displayed automatically by the computer, you don't have to memorize a long list of commands or keystrokes to get the computer to respond correctly to your instructions. This makes a GUI extremely easy to use.

Amiga computers provide a versatile GUI known as the *Workbench*. For an introduction to the basics of the Workbench, see Chapter 3 of this manual. For complete details on the Workbench, refer to the *Using the System Software* manual included with your computer.

Command Line Processing

In *command line processing*, you type in each command or instruction to the computer. Although command line processing is not as simple to use as GUI processing, command line instructions can be made very precise. Command line processing can therefore be very useful — even essential — in advanced processing situations.

Amiga computers offer a highly sophisticated, easy-to-use command line processing system known as the *Shell*. With the Amiga's multitasking capabilities, you can open a number of Shells at one time.

For added versatility, the Workbench and Shell work together. You can load the Workbench using the Shell, and you can call up the Shell from the Workbench. (See the *Using the System Software* manual for details on the Shell.)

Multitasking

Multitasking is the ability of a computer to handle a number of tasks or programs operating simultaneously. This concurrent activity does not require any action by the user, and does not depend on special programming techniques. Multitasking ability is unique to the Amiga line of computers, when compared with computers in or near their price ranges.

Text-to-Speech Conversion

The Amiga has the ability to convert text input directly to speech. There are controls for rate, pitch, volume, inflection, and even type of voice (male, female, computer). This is another standard ability that is unique to the Amiga family of computers.

Stereo Sound

The Amiga has four independent sound channels, configured as one stereo or two mono channels. The Amiga sound system can reproduce complex waveforms and can perform 8-bit digital-to-analog conversions.

AUTOCONFIG™

All expansion slots are controlled by a feature known as AUTOCONFIG™, which automatically recognizes an expansion card installed in the A3000. AUTOCONFIG ensures that the system is aware of the added capability; the user does not have to run a special setup program or change hardware switches.

Graphics Capabilities

This section summarizes the types of screen display that you can use with your A3000. (The type of screen display is also referred to as the *display mode*.) For details on the display modes available, see Chapter 3 in the *Using the System Software* manual.

Changing the display mode changes the number of pixels that make up the screen. This is also known as the screen resolution. The higher the number of pixels, the sharper the image becomes.

The standard Workbench screen that appears when you turn on (boot) your A3000 is known as a Hires (high-resolution) interlaced screen. It is 640 pixels wide (left to right). Its height is determined by your country's video standard: NTSC, the video standard used in most of North America, parts of Latin America, and Japan; or PAL, the video standard used in Europe, Australia, and New Zealand. For an NTSC display, a Hires interlaced screen is 400 pixels high (top to bottom); for a PAL display, it is 512 pixels high.

Certain software, like desktop publishing, or CAD/CAM programs, require this higher resolution in order to present the information clearly. For instance, if a desktop publishing program is used in a low-resolution screen (320 x 200/256 pixels), the text will not be clearly defined—circular letters may have jagged edges or portions of letters may appear to be missing. You will not be able to see a true representation of your page. However, the same page on an Amiga Hires-interlaced screen (640 x 400/512 pixels) will be sharp and crisp. It will more closely resemble the printed output.

The display modes available to you may depend upon the type of monitor you are using. Interlaced screens may flicker when used with certain monitors. The A3000's built-in Display Enhancer is designed to eliminate the flicker (when used with a multiscan monitor).

The following chart lists the display modes, the hardware needed to use that mode, and the standard screen sizes.

Graphics Display Mode	Special Requirements	Standard Screen Size (Pixels)	Maximum Number of Colors
Hires		640 x 200/256	16
Hires Interlaced		640 x 400/512	16
SuperHires		1280 x 200/256	4
SuperHires Interlaced		1280 x 400/512	4
Productivity	Multiscan monitor	640 x 480	4
Productivity Interlaced	Multiscan monitor	640 x 960	4
A2024/10Hz	A2024 monitor	1008 x 800/1024	4 shades of grey
A2024/15Hz	A2024 monitor	1008 x 800/1024	4 shades of grey

Note that the display mode you choose only pertains to the Workbench screen. (See Chapter 3 in this manual and the Workbench chapters in the *Using the System Software* manual for information on the Workbench.) If your software application opens its own screen, you should check the documentation for the application to see which display modes the application supports.

Your Amiga 3000 additionally supports the following display modes, which are not used by Workbench but which are available to applications which open their own screens.

Graphics Display Mode	Standard Screen Size (Pixels)	Maximum Number of Colors
Lores	320 x 200/256	32
Lores Interlaced	320 x 400/512	32
HAM	320 x 200/256	4096
HAM Interlaced	320 x 400/512	4096

For More Information . . .

The features briefly noted in this chapter have been selected to show the A3000's wide range of capabilities. Refer to the appendices of this manual for more information on A3000 hardware features. Refer to the *Using the System Software* manual for more information on Amiga software features.

Chapter 3

Getting Started

This section introduces the basics for using your A3000.

For full details on using your A3000, you should read the *Using the System Software* manual packaged with your computer.

This manual provides complete information on the Workbench, which is the graphical user interface for users who are new to the Amiga. The *Using the System Software* manual includes step-by-step tutorials on each feature of the Workbench. You will of course have to follow the instructions given in the user's manual for each program that you want to use.

NOTE: As a result of Commodore-Amiga's ongoing product improvement program, the displays shown in this manual may differ slightly from those that appear on your monitor.

About Software

Software is a set of instructions (often called a *program*) that tells your computer what to do. There are many kinds of software, including:

- application programs, such as word processors, video titlers, spreadsheets, databases, games, drawing programs, music programs, etc.
- programming languages, such as C, AREXX, etc.

- utilities, such as file management programs or font editors
- operating systems, such as AmigaDOS®, which controls how your Amiga interacts with you and with the equipment in your system

Software is contained on some form of *storage medium*, most often a *floppy disk* or a *hard disk*. For those new to computing in general or to Amiga computing in particular, the next section provides an introduction to floppy and hard disks.

About Disks

There are two main types of computer disks: floppy disks and hard disks. Floppy disks offer low cost and transportability. Hard disks offer high speed and relatively large storage capacity.

Information on disks is stored magnetically, in somewhat the same way that sound is recorded on audio tape. You can copy the information on a disk to another floppy disk or hard disk, or to other storage media (e.g., tape).

A computer can include both floppy drives and hard disk drives, as well as other storage devices, such as a tape unit. Your A3000 includes at least one floppy disk drive and one hard drive. Additional floppy disk drives are available from Commodore and third party manufacturers as internal or external add-on peripherals. Additional hard disk drives are available from third party manufacturers as internal or external add-on peripherals.

Floppy Disks

Floppy disks are sheets of magnetically coated material enclosed in a square protective cover. In order for the computer to *read* (retrieve) information from a disk or to *write* (save) information to a disk, you must insert the disk in a floppy disk drive.

The 3.5 inch floppy disks used with the A3000 have a rigid plastic shell and a metal cover (known as a *shutter*) for protection against damage, fingerprints, etc. Each Amiga 3.5 inch floppy disk holds 880 *kilobytes* (abbreviated **880K**) of data. This is roughly equivalent to 400 typewritten pages.

Protecting Floppy Disk Information

Note the small plastic tab on the back of each floppy disk. This is known as a *write-protect* tab. When you receive your A3000, the tab on each disk should be in the upper position (i.e., at the top edge of the disk). This position is known as the *write-inhibit* position. When the tab is in this position, you should be able to see through a small hole in the plastic disk cover.

With the tab in this position, you can *read* (that is, retrieve) the information on the disk, but you cannot *write* to the disk (that is, you cannot change the information or add new information).

If you want to *write* to the disk, simply move the tab down (i.e., toward the middle of the disk), so that it covers the hole. This position is known as the *write-enable* position.

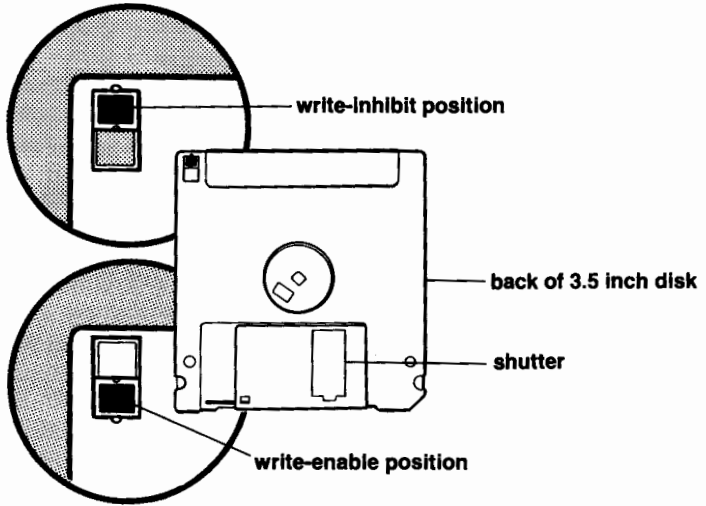

Although the disk housing is relatively sturdy, you should follow certain rules in handling the disks. For a list of these rules, see the *Caring for Your Amiga* section at the end of this chapter.

IMPORTANT: In addition to the 3.5 inch Amiga disks packaged with your computer, you should always have some blank 3.5 inch floppy disks ready. (You can get blank disks from various sources — your Amiga dealer, computer stores, office supply stores, etc.). Use only double-sided, double-density disks.

Chapter 1 of the *Using the System Software* manual tells how to copy the information from the original Amiga disks onto blank disks. This is important because it will allow you to work with the copies (known as *working disks*) and keep the originals in a safe place. You can use the originals to make new backups if the first copies become damaged in any way.

Hard Disks

Hard disks typically hold from 10 megabytes to hundreds of megabytes of data (the upper limit for storage capacity is being raised continually). A hard disk is enclosed in a sealed housing. Information moves to and from the hard disk electronically — the disk is never touched by the user.

The A3000 includes an internal hard disk, located in a bay at the center rear of the main unit.

See *The A3000 Hard Disk* section later in this chapter and Chapter 6 in the *Using the System Software* manual for more information on the hard disk.

About the Mouse

While working with your computer you will generally be using the *mouse*. The mouse controls the movement of a small, arrow-shaped pointer on the display screen. When you move the mouse over a flat surface like a desk or table top, the pointer on the screen moves in the same direction as the mouse.

There are two buttons on the mouse. The left mouse button is called the *selection* button; the right button is called the *menu* button. These terms are explained later in this section.

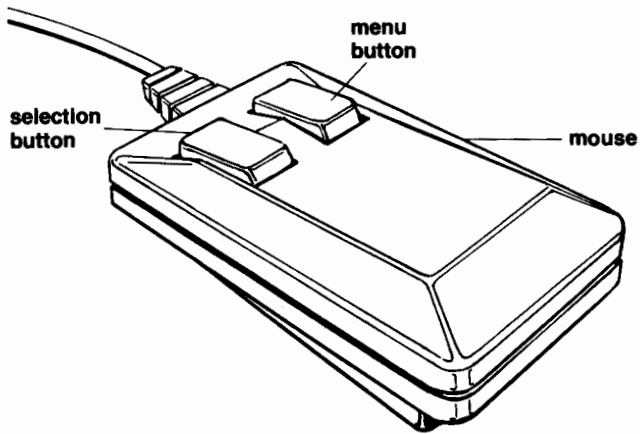

For details on caring for the mouse, see the *Caring for Your Amiga* section at the end of this chapter.

NOTE: The descriptions in this chapter and throughout the rest of this manual assume that you are using a mouse. However, there are certain keys on the keyboard that you can use in place of the mouse. For details, see Chapter 2 in the *Using the System Software* manual.

Turning On the A3000

NOTE: Before you turn on your A3000, be sure that you have correctly installed and connected all the equipment in your A3000 system. See the *Amiga 3000 Quick Connect* for instructions on connecting equipment to your computer.

First, turn on the monitor and any other equipment attached to your A3000. (See your equipment manuals for further information.)

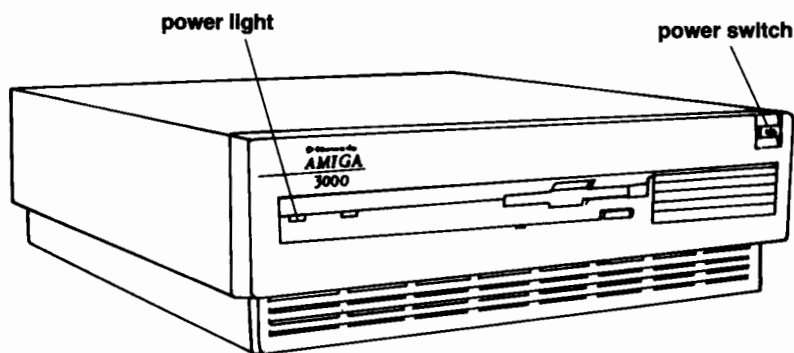

Next, press the power switch located on the upper right front of the A3000. The power light on the left front of the A3000 will light up.

Booting the A3000

The process of starting a computer is often referred to as *booting* the computer. The Amiga 3000 can be booted from either the hard or floppy disk drive.

Booting from the Hard Disk Drive

The A3000 is set to automatically boot the Amiga from the hard disk. Simply turn on the computer and in a short time the *Workbench screen* appears on your monitor. (For an introduction to the Workbench screen, see pages 3-10 through 3-14.)

Booting from the Floppy Disk Drive

You can also boot the A3000 from the floppy drive. To do this, BEFORE you turn on the A3000, insert the Workbench or a bootable program disk in Drive DF0:. (This is the A3000's internal floppy disk drive. If you have two internal floppy drives, DF0: is the drive on the right.) If the A3000 finds a bootable floppy disk in Drive DF0:, the computer will boot from that disk rather than the hard disk.

For details on booting from a floppy disk, see Chapter 1 of the *Using the System Software* manual.

Workbench — The Amiga Graphical User Interface

An easy way for users to operate a computer is through a *Graphical User Interface (GUI)*, which is a pictorially oriented system. When working with a typical GUI, you use a *mouse* to move an arrow-shaped symbol called a *pointer* around the monitor screen. The pointer is used to select *icons*, which are small pictures that identify items such as files or functions.

In some cases the selection involves a *menu*, which is a list of options from which you can pick the item or function you want.

The process may also involve one or more *windows*, which are special areas of the screen that can accept and/or display information.

The Amiga provides a powerful GUI known as the *Workbench*. The Workbench combines the mouse, pointer, icons, menus and windows with its own special Amiga tools. The result is sophisticated computing power right at your fingertips, in a very easy-to-use package.

The Workbench Screen

NOTE: This section provides a brief introduction to the Workbench screen. For complete information, including tutorials, on all elements of the Workbench, see Chapters 1 through 6 of the *Using the System Software* manual.

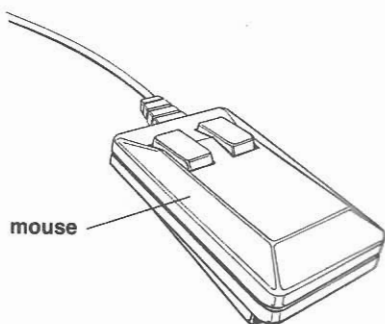
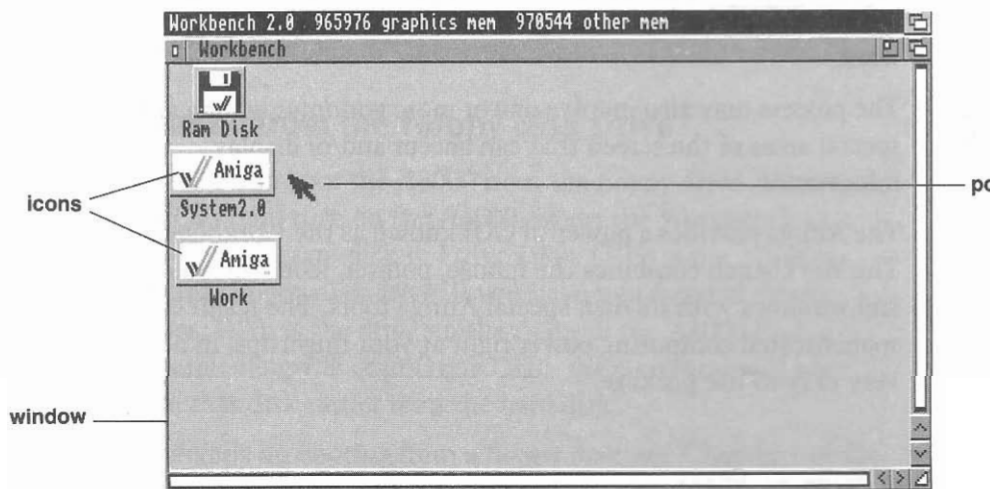

Notice the *title bar* at the top of the screen. This identifies the screen as the *Workbench*. On the Workbench are several *icons* (small pictures or symbols). The icons on the screen represent the currently available A3000 storage devices (hard disk, floppy disk, RAM disk, etc.). To learn all about these icons, see the *Using the System Software* manual.

Moving the Pointer and Selecting

The small arrow on the screen is known as the *pointer*. You use the mouse to move the pointer to select items on the screen.

If, while you are moving the mouse, you run out of desk space and your pointer still is not where you want it to be, just lift the mouse off the desk and put it down where there is room. Lifting the mouse does not move the pointer.

NOTE: The size and shape of the pointer, as well as the rate at which it moves, can be changed. See the *Using the System Software* manual for details.

As noted previously, *icons* are used to represent various Amiga items, such as files, drawers and tools. When you want to use an icon, you must move the pointer to that icon and *select* it.

To perform the selection function, you use the *left* button on the mouse. For this reason, the left mouse button is known as the **selection** button.

As an example, use the mouse to move the pointer to the *Work* icon. Then click (press) twice on the **selection** (left) button. (This action is known as *double clicking*.) Be sure to press the button twice in rapid succession.

Notice that the *Work* icon is highlighted at the first press of the mouse button. This indicates that the icon has been selected. After the second press of the left button, the *Work* window will appear.

Sometimes when you double-click on an icon, the pointer changes shape and becomes a *Wait* pointer.

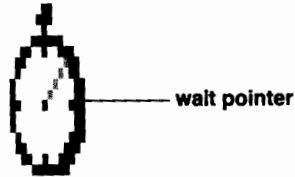

When you see this pointer, it means that the Workbench is busy doing what you asked it to do. When the pointer returns to its original shape, you can continue working.

ART

If you decide you no longer want an icon selected, move the pointer to any location on the Workbench screen that is not occupied. Then click *once* on the **selection** (left) button.

About Menus

Menus provide a list of the choices available to you. To make a choice from a menu, you use the *right* mouse button. For this reason, the right mouse button is known as the **menu** button.

Holding down the menu (right) button causes a **menu bar** to appear across the top of the screen. The menu bar shows the headings of any menus that are available to you.

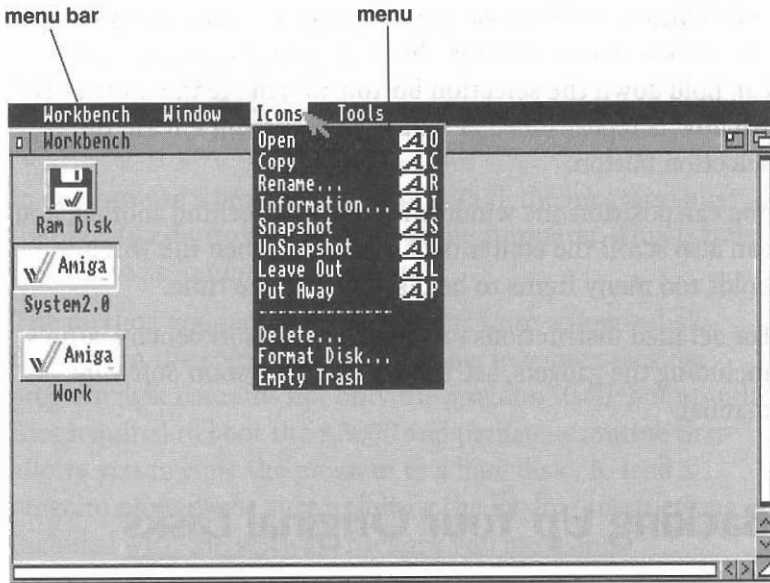

NOTE: For full details on selecting icons and using menus, see the *Using the System Software* manual.

Additional Workbench Features

There are many special features available on the Amiga to ensure peak performance. For example, since the Amiga is a *multitasking* system, it is possible to open a number of windows and have a variety of programs running at the same time. This can put a premium on screen space. The Workbench therefore provides ways to manage the screen output and functions for optimum results.

You may have noticed the *gadgets* — the small symbols in the border and corner areas of windows. These *gadgets* allow you to customize the size, position, and other characteristics of windows shown on the Workbench screen.

For example, you can use gadgets to move windows by a process known as *dragging*. To drag a window, point to its title bar, hold down the selection button, and move the mouse. The window is repositioned at whatever point you release the selection button.

You can position one window in front of or behind another. You can also scroll the contents of a window when the window holds too many items to be displayed at one time.

For detailed instructions on using all the Workbench features, including the gadgets, see the *Using the System Software* manual.

Backing Up Your Original Disks

Before you do anything else with your A3000, you should BACK UP (that is, make a copy of) your floppy disks. By backing up your floppy disks, you will ensure that even if a disk is lost or damaged you will still have a copy of it.

For step-by-step instructions on how to copy floppy disks, refer to Chapter 1 of the *Using the System Software* manual.

When you've made a copy of a disk, put the original in a safe place and use the copy, called a *working disk*, for everyday use. If you lose or damage a working disk, you'll always be able to make another working disk from the original.

Loading Programs from a Floppy Disk

In order to use a program on your A3000, the program must first be placed into the memory of the computer. This is often referred to as *loading* the program.

The method you use to load programs from a floppy disk depends on the software you are using. In some cases the program disk contains not only the program itself, but also the files required to boot the A3000 and perhaps a routine that allows you to copy the program to a hard disk. To load a program properly, be sure to follow the loading instructions included with the software package you are using.

When you are loading a program from a floppy disk, the light on the disk drive will come on, indicating that the disk drive is active. **DO NOT ATTEMPT TO INSERT OR REMOVE A FLOPPY DISK WHILE THE DRIVE ACTIVITY LIGHT IS ON.** Once the program is loaded, follow the operating instructions supplied in the software documentation.

Refer to the *Using the System Software* manual for detailed instructions on how to load and run programs.

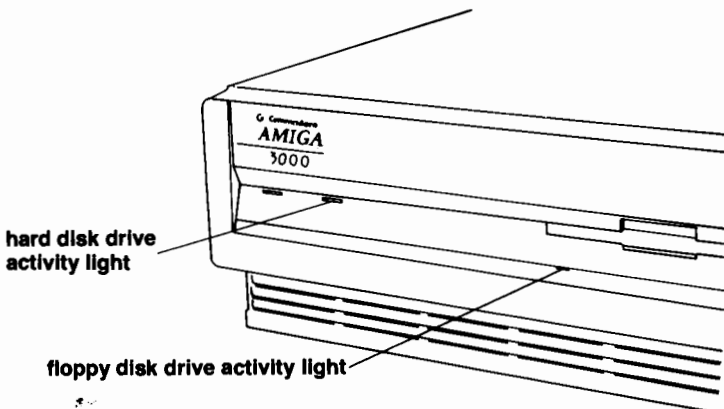

Saving Your Work

Most software has a specific procedure for saving your work. For exact instructions on saving your work, see the user's manual for the application software you are using.

Turning Off the A3000

When you finish a computing session and want to turn off the A3000, first save any work that you want to keep. Next, remove any disk(s) from the floppy drive(s). Then press the power switch on the right front of the A3000. The power light on the left front of the A3000 will go out. Turn off the monitor and any peripherals.

WARNING!

- **DO NOT TURN OFF THE A3000 OR REMOVE A DISK FROM A DRIVE IF ITS FLOPPY DISK DRIVE ACTIVITY LIGHT IS ON.**
- **WAIT AT LEAST 5 SECONDS AFTER THE HARD DISK ACTIVITY LIGHT GOES OUT BEFORE TURNING OFF YOUR A3000.**

IMPORTANT: Turning off or rebooting the computer erases whatever is in the memory of the computer, so be sure to save your work before you use these procedures. See the Using the System Software manual for details on saving and rebooting.

The A3000 Hard Disk

Your A3000 comes with a built-in hard disk. The hard disk has a storage capacity equivalent to that of dozens of floppy disks. The hard disk allows faster storage and retrieval of information than a floppy disk.

Following is general information about the hard disk. For specific instructions on hard disk use, see the *Using the System Software* manual, especially Chapter 6.

Formatting prepares the disk to receive data in a form compatible with the Amiga's operating system. The A3000 hard disk has already been *formatted* at the factory. If you install another hard disk, that disk must be formatted by you or your dealer.

Copying Programs to the Hard Disk

The Workbench2.0 and Extras software have been factory-installed on the A3000 hard disk. You will also want to transfer other programs to your hard disk. The documentation for many programs that you purchase will tell you how to do this. If a program lacks such documentation, see the *Using the System Software* manual for copying instructions. The System Software manual also gives complete instructions on how to perform all file handling procedures, such as moving a file, combining one file with another one, deleting a file, etc.

Loading Programs from the Hard Disk

If the floppy disk for a program is not *copy-protected* (that is, if the originator has not made it impossible for a copy to be made using standard copying procedures), you can copy the program to the hard disk. You will then be able to load and run the program from the hard disk, usually much faster than you could do from a floppy disk.

Saving/Retrieving Hard Disk Files

You can save files to and retrieve files from the hard disk as you would a floppy disk. See the *Using the System Software* manual for instructions on how to save and retrieve hard disk files.

Backing Up the Hard Disk

The information on a disk (hard or floppy) may be damaged or destroyed by a hardware or software failure. To ensure that you have a copy of your important programs and files, you should back up your floppy and hard disks. Since a hard disk can store large amounts of information, it is especially important that you back up the hard disk periodically.

Special software is included with your A3000 computer to allow you to back up the hard disk by copying the information stored on the hard disk to another storage medium like floppy disks or an optional streaming tape drive. See Chapter 6 and Appendix C in the *Using the System Software* manual for information on hard disk backup procedures.

You should back up the hard drive frequently — daily or weekly, depending on how often the information is used and how important the information is. Without a backup copy, it will be impossible for you to replace any files that may be lost due to user error, or to system or hard disk failure.

Contents of the Hard Disk

A hard disk's storage area can be divided into a number of *partitions*, or subdivisions. As shown in the Workbench screen on page 3-10, the A3000 hard disk has two partitions: **Work** and **System2.0**. The Work partition is empty when you receive your A3000. You can use this partition to store your programs and files. The System2.0 partition includes a copy of the Workbench software you use in working with the A3000, the startup files that tell the computer how the system is to be set up, directories and files that are on the Workbench and Extras floppy disks, plus various other software, such as utilities.

***** IMPORTANT *****

For complete information on using the hard disk, including how to use the backup software, refer to the Using the System Software manual.

Caring for Your Amiga

Your Amiga needs very little care to keep it working at its best. Observe the following precautions to keep your Amiga in top shape.

- *Keep the Amiga dry.* Keep liquids away from the Amiga. An accidental spill can seriously damage disks or the Amiga itself.
- *Keep the Amiga out of temperature extremes.* Working temperature range is 0 to 45°C (32 to 113°F). Storage temperature range is 0 to 60°C (32 to 140°F). If the system experiences excessive heat or cold, the Amiga may not function reliably.
- *Keep connectors and the ends of cables clean.* Any substance that adheres to connectors or the ends of cables can prevent a good electrical connection or damage the connector.
- *Keep magnets away from the monitor, and all other components of the computer setup.* Although magnets won't damage the monitor, they can distort the video display and they can damage disks. In addition to more obvious magnets, beware of magnets in telephones, electronics equipment (especially loudspeakers), and electric motors.
- *Do not attempt to service your Amiga yourself.* If your Amiga needs service, take it to an authorized Amiga Service Center. Attempting to service the computer on your own will void the warranty on your Amiga.

Cleaning the Mouse

Use the mouse on a clean surface. The ball on the bottom of the mouse must be clean to work properly. If the mouse behaves erratically, it may need cleaning.

To clean the mouse, you will need:

- *a soft, dry, lint-free cloth*
- *alcohol, or head cleaning fluid for tape recorders*
- *cotton swabs*

Here's how to clean the mouse:

- Turn the mouse upside down with its cable toward you. Hold the mouse in both hands and put your thumbs on the ridged panels on either side of the ball.
- With your thumbs, firmly turn the ball cover to the open position. With the mouse upside down, lift off the cover.

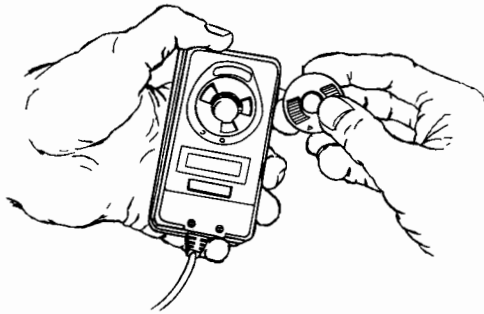
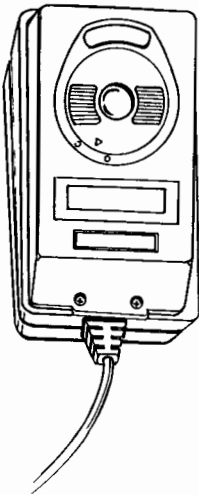

- Put your hand over the opening, turn the mouse right side up, and catch the ball.

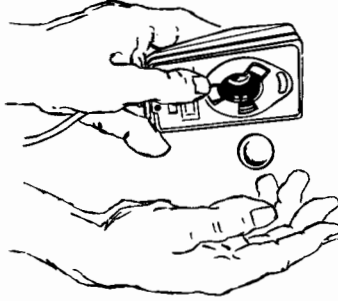

- In the opening, you will see small rollers. Moisten a cotton swab with isopropyl alcohol or tape head cleaning fluid and gently swab the surface of each roller. Turn each roller as you swab to clean it all the way around.

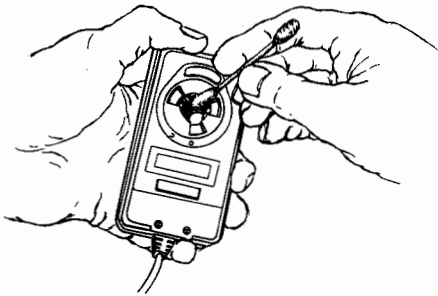

- Use the cloth to wipe off the mouse ball. (Do not use any liquid when cleaning the mouse ball.) When you are done, blow gently into the opening to remove any dust, replace the ball, and replace the cover for the ball.

Taking Care of Floppy Disks

To protect the information on your floppy disks, observe these precautions:

- *Make copies (working disks) of important disks.* Work with the copies and keep the originals in a safe place for use as backups if the copies become damaged. See the *Using the System Software* manual for details on copying disks.
- *Never remove a disk from a drive when the drive light is on.* The disk drive light tells you that the Amiga is using a disk.
- *Don't touch the surface of the disk.* The metal shutter on a floppy disk closes automatically whenever you remove the disk from a disk drive. Do not touch the surface of the disk underneath the cover.
- *Keep disks away from magnets.* Disks store information magnetically. Magnets can ruin the information on a disk.
- *Keep disks away from extreme heat or cold.* Do not leave disks in direct sunlight, near heat sources, or in cars parked in the sun.

Chapter 4

Expanding the Amiga 3000

This chapter summarizes the expansion options available with the A3000 and provides general illustrations showing how these options can be installed in the A3000 chassis. For detailed information see the user's manual for the option you are installing.

Expansion Options Available

There is a large and continually growing list of options you can choose from to take advantage of the extensive expansion capabilities of the A3000.

Using Expansion Slots

There are four 100-pin Amiga bus expansion slots, one 200-pin *Fast* slot, one video expansion slot, and two 86-pin PC/AT™ slots. All slots except the *Fast* slot are located on the daughterboard, which is perpendicular to the A3000 motherboard. Two of the 100-pin Amiga slots are in line with PC/AT slots.

The 100-pin expansion slots are compatible with A2000 expansion cards (ZORRO II cards), while offering increased performance for new devices developed specifically for the A3000 (ZORRO III cards). These slots can accept a variety of options, including video digitizers, audio samplers, multiport I/O boards, etc. — all within the main chassis of the computer. Such options, available from Commodore and from many third parties, increase the power of your A3000 without increasing its desktop footprint.

The *Fast* slot on the local 68030 bus can be used for future expansion, such as a Motorola 68040 microprocessor or other high-performance options.

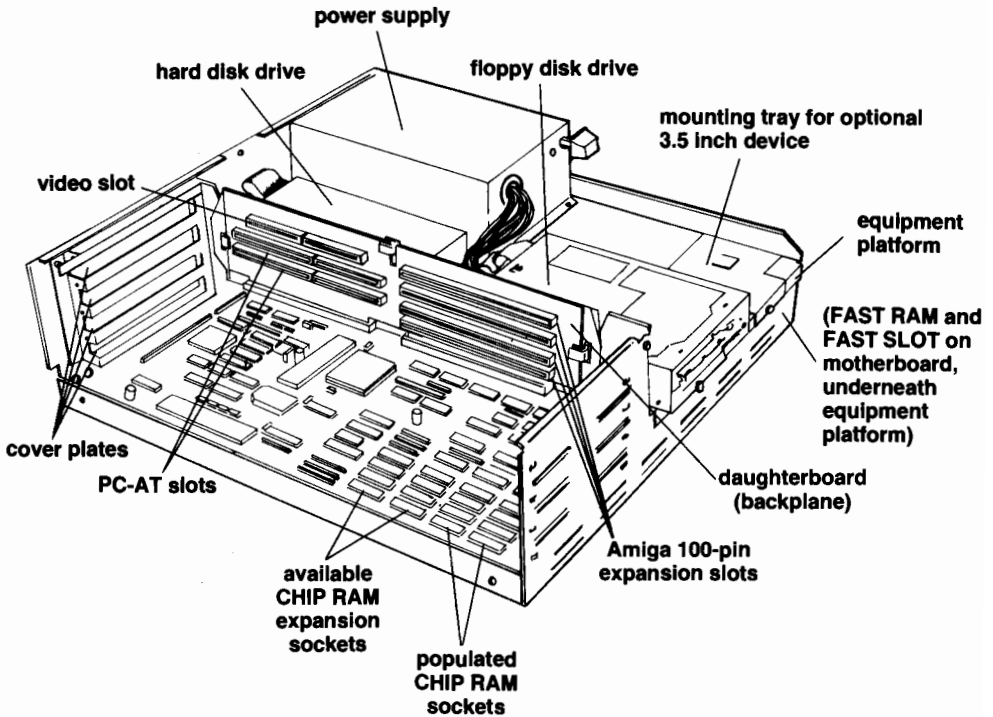

Memory Expansion on the Motherboard

Two types of chips may be used, allowing a maximum of either 6 MB or 18 MB of memory on the motherboard. All this RAM can be directly addressed by the operating system. Because no paging or other time-consuming RAM accessing scheme is required, processing speed is increased.

Chip RAM Expansion

The A3000 comes with one megabyte of Chip RAM (also known as graphics RAM), out of the total of two megabytes of system RAM on the motherboard. You can add another megabyte of Chip RAM by having an authorized Amiga service center install additional chips into the sockets provided on the motherboard.

Video Expansion

The A3000 provides a video expansion slot for internal video expansion, such as a television encoder or a genlock interface. Using this slot keeps all video circuitry in the metal housing of the A3000's main unit, helping to minimize RF problems.

The video slot is located at the top of the daughterboard, in line with a standard Amiga bus expansion slot. This allows a video expansion card to be designed to incorporate, or be easily connected to, a standard Amiga expansion card.

Genlocks can be connected to the A3000, either internally (via the video slot) or externally. This provides a cost-effective way to add sophisticated Amiga computer graphics, special effects and titles to video output, videotapes, etc.

The analog RGB output of the A3000 directly supports encoders and genlocks. These optional devices allow the A3000 to conform to television standards (either the European PAL or North American NTSC). This means that the A3000 can be connected to standard video equipment, including monitor and projection type television displays. With the exception of the genlock or encoder itself and possibly the cabling, no special equipment is needed. The A3000 can also work in conjunction with television studio equipment for a wide variety of tasks, such as paintbox graphics, character generation, and animation.

Adding Disk Drives

The A3000 has internal mounting bays for three 3.5-inch drives. Two bays have external and internal access, while one bay has internal access only. In the standard A3000, two bays are occupied: one by a floppy drive and one by a hard drive.

A floppy drive can also be added externally, using the floppy disk connector on the rear of the main unit.

Adding SCSI Devices

The A3000's built-in DMA SCSI controller allows the connection of up to seven SCSI devices, including hard drives, scanners, tape units, CD-ROMs, etc. There are internal and external SCSI connectors.

PC Emulation With Bridgeboards

Commodore produces a line of PC emulator cards known as *Bridgeboards*. Each Bridgeboard is a fully functional PC that includes its own microprocessor and the circuitry needed to interface between the PC and Amiga systems. Since the Amiga has multitasking capability, the Bridgeboard can run concurrently with Amiga programs. The Amiga emulates CGA/MDA types of PC displays in a window on the Amiga monitor.

The Bridgeboard/Amiga hybrid architecture may be used for applications where the PC system functions as a coprocessor. The dual-port RAM provides the path for the communications between the two systems. There is full access to the complete range of PC compatible add-ons. You can also set up the A3000 hard disk drive for use by both MS-DOS and AmigaDOS.

A Bridgeboard can be installed in one of the two PC/AT-compatible expansion slots on the Amiga daughterboard. The other PC/AT-compatible slot can then be used for a PC card (e.g., a video card). With a Bridgeboard installed, the A3000 can run MS-DOS (or other PC-compatible operating systems) and popular MS-DOS compatible software packages.

Installing Options

CAUTION: Before any internal expansion device is installed, the A3000 must first be turned off and disconnected from the power receptacle. All cables for peripherals should be disconnected from the A3000.

This section gives general information on installing options for the A3000. It is assumed that installing an option inside the A3000 always includes:

1. Turning off the A3000 and disconnecting it from the power socket. Failure to do so could endanger both you and your computer.
2. Removing the A3000's cover.
3. Reassembling the A3000 and replacing the cover.

Removing the A3000's Cover

To remove the A3000's cover, remove the two screws on the lower left side of the A3000. Remove the two screws on the lower right side of the A3000. Remove the center screw from the rear of the A3000. Put the screws aside.

Turn the A3000 so that you are facing the front of the machine. Grasp the cover on both sides and slide it towards you.

If the cover seems stuck, do not force it. Look under the cover to see if any wires or cables are caught on the cover. If anything is caught, gently untangle it, and continue to slide the cover off.

Removing the Cover

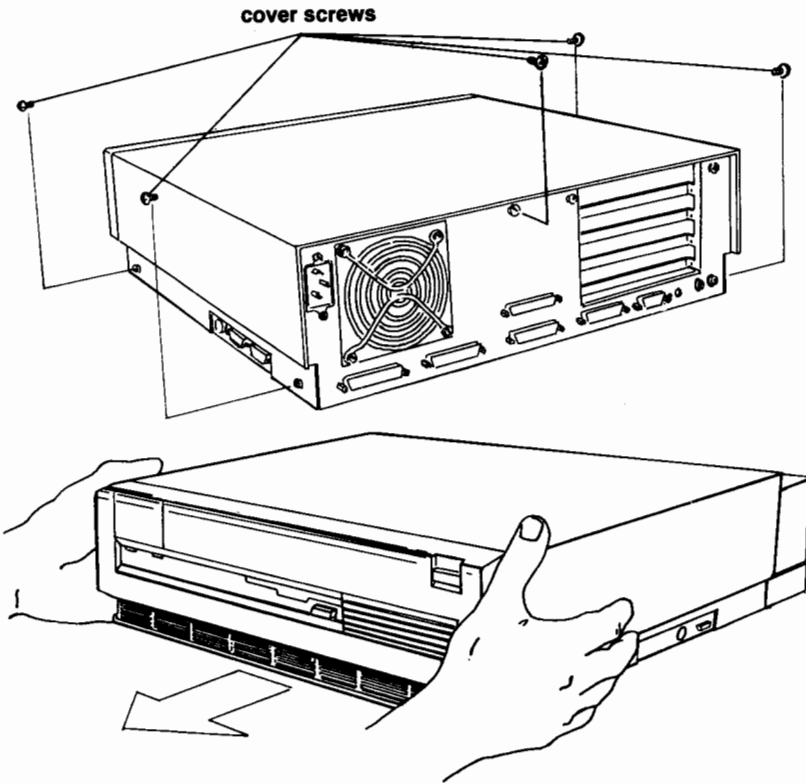

Installing Expansion Cards

Expansion cards are installed on the daughterboard.

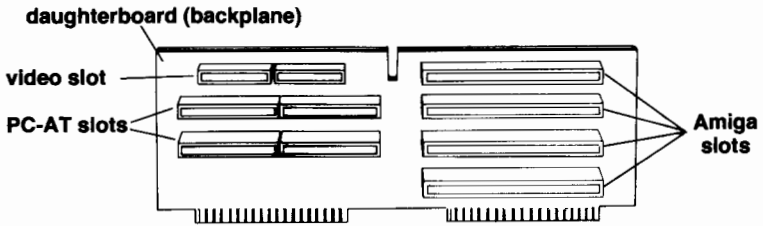

Installing Expansion Cards

1. Remove cover plate if access from outside the machine is required (for I/O ports, etc.)
2. Insert card in selected slot. Make sure that the card is in the proper card guide in the front of the A3000, and that the appropriate edge card connectors are aligned correctly. Press firmly, but do not use excessive force.
3. Reinstall the cover plate screw to hold the card in place.

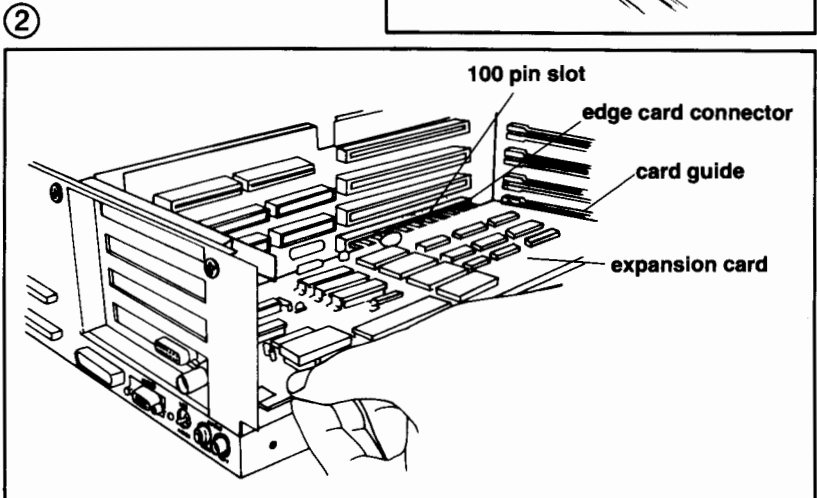
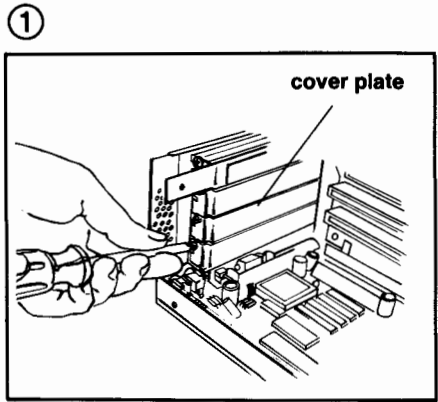

Installing Video Expansion Cards

A video card is installed in the video slot at the top of the daughterboard.

Installing Video Cards

1. Remove screw from cover plate.
2. Lift off cover plate.
3. Unscrew adapter strip from cover plate and attach cover plate to video card.
4. Insert video board in appropriate side of video slot on daughterboard.

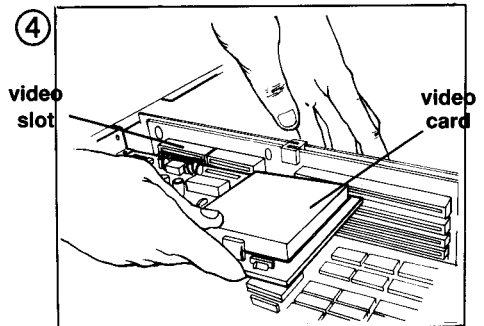
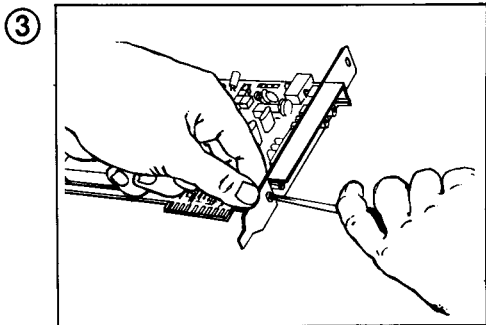
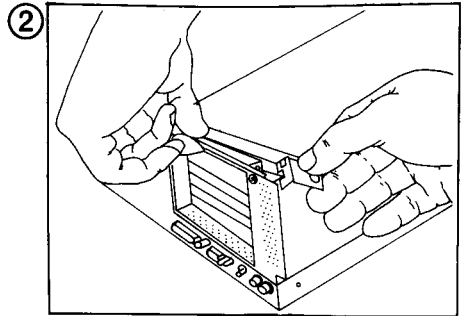
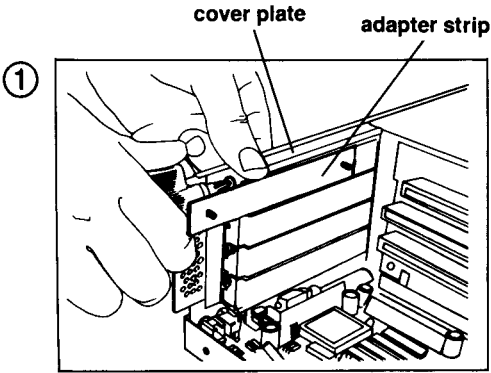

Installing Hard and Floppy Disk Drives

There is space in the A3000 expansion bay on the right side of the chassis for three 3.5 inch drives. The standard A3000 as shipped has a 3.5 inch floppy drive mounted in the left front bay and a 3.5 inch hard disk mounted in the rear drive bay, just behind the floppy drive. You can install another 3.5 inch floppy or hard drive in the bay next to the floppy drive. You can also replace the original hard drive if you wish.

The following are general comments on installing an expansion device (e.g., a drive) in the expansion bay. For more specific instructions see the user's manual for the expansion item being installed.

If a hard drive with a faceplate is to be mounted in one of the front bays you will need to remove the faceplate.

There are two ribbon cables that connect the drives to the motherboard. The wider cable (50 pins) is used for the hard drive and other SCSI devices. The narrower cable is used for floppy disk drives. Each ribbon cable has two connectors. There are also power cables used to connect the drives to the power supply. Note the orientation of the power cables and ribbon cables of the standard drives before disconnecting the cables from the drives.

Note the slots in the equipment platform. The brackets on the device mounting plates fit into these slots. When installing a device, make sure the mounting brackets on the plate go through the slots in the equipment platform.

Connect the appropriate ribbon cable to the device. Make sure that the cable is aligned properly and that pin 1 on the ribbon cable is aligned with pin 1 on the device connector.

Connect the device to the A3000's power supply. Locate the wires running from the power supply. Attach one of the power connectors to the device's power connector. The power connector is shaped so that it can fit only one way.

Reassemble the computer components and replace the cover.
Reconnect whatever equipment has been disconnected.

Removing/Installing a Floppy Disk Drive

1. Remove front screw.
2. Lift drive from equipment platform.
3. Disconnect power connector.
4. Disconnect ribbon cable.
5. Remove mounting plate screws.
6. Lift off mounting plate.

NOTE: To install a drive, reverse these steps.

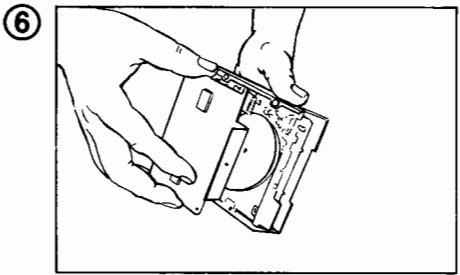
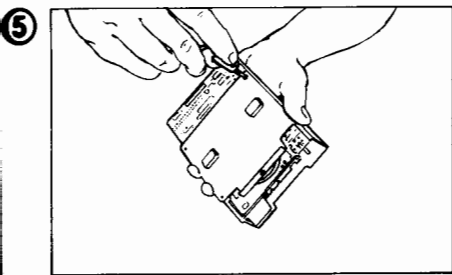
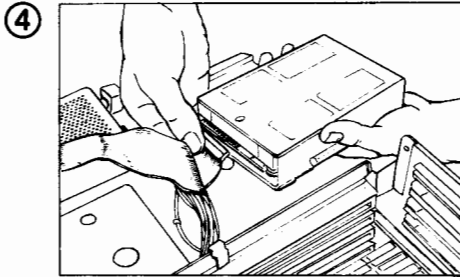
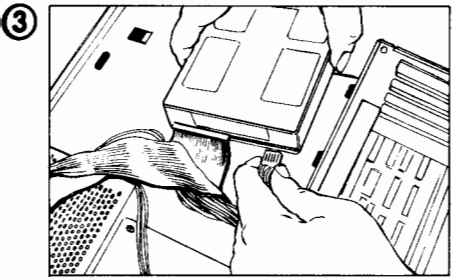
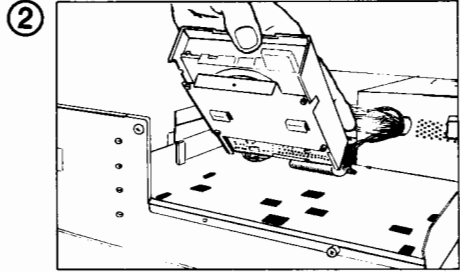
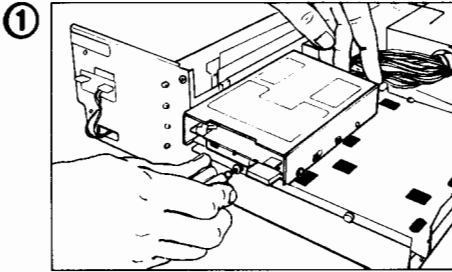

NOTE: To install a second floppy drive, first move the original floppy drive to the drive bay on the right side of the chassis. (Remove the bezel to permit access to the drive.) Install the second floppy drive in the left bay. Move Jumper J351 on the motherboard.

Removing/Installing a Hard Disk Drive

1. Remove front screw.
2. Lift drive from equipment platform.
3. Disconnect power connector.
4. Disconnect ribbon cable.
5. Remove mounting plate screws and lift off mounting plate.

NOTE: To install a drive, reverse steps 1 through 5. Then adjust jumper settings on the hard disk to provide a unique SCSI address.

Also, if both internal and external add-on SCSI devices are present, the termination resistor packs must be removed from the original hard disk for proper SCSI operation.

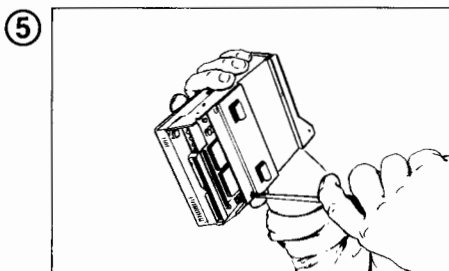
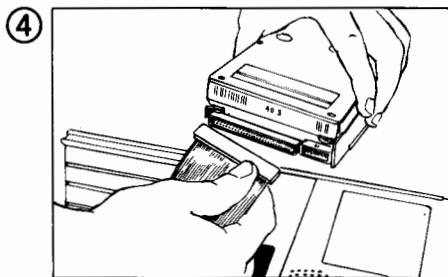
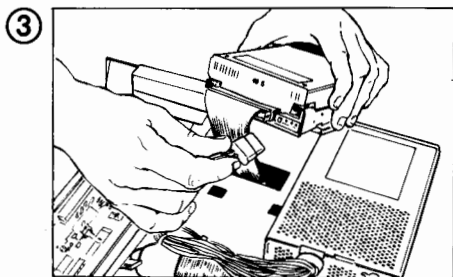
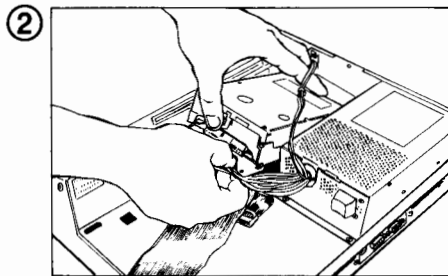
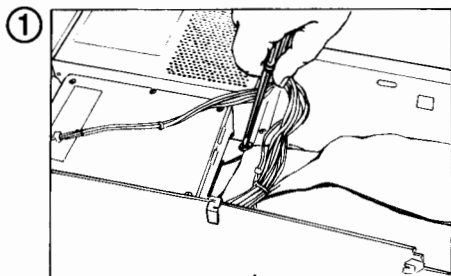

Installing Random Access Memory (RAM) Chips

Sockets are provided on the motherboard to allow the user to increase the amount of memory in two of the A3000's memory subsystems—Fast memory and Chip (graphics) memory. To increase Fast memory, memory can also be added via ZORRO II/III expansion cards. However, the Fast memory system provided on the motherboard allows expansion while leaving the expansion slots available for other devices. It is therefore recommended that RAM be expanded via the sockets provided on the motherboard in order to ensure maximum system expandability.

WARNING: Installation of RAM chips should be performed by an authorized Commodore-Amiga Service Center, or by your Commodore-Amiga dealer. Commodore-Amiga will not be responsible or liable for any damages caused by improper installation of RAM chips.

CAUTION: If the A3000 is connected to a power outlet, the power must be turned off and all cables and peripherals must be disconnected from the A3000, before the A3000 case is opened.

RAM chips are sensitive to static electricity. Contact with a chip when high levels of static electricity are present could ruin a chip. Touching a nearby grounded metal surface before touching the chip can help reduce static levels.

In general, the following steps are required to install RAM chips:

1. Disconnect the A3000 from power.
2. Remove the cover of the A3000.

3. If adding Fast RAM, remove the equipment platform and disconnect the power harness and equipment cables from the motherboard for whatever equipment is installed on the platform.
4. Insert the RAM chips.
5. Adjust the RAM size jumper (if necessary).
6. Reassemble the A3000 and reconnect all equipment.
7. Check that the A3000 recognizes the new memory at power up.

Fast Memory

Fast memory (also known as Fast RAM) is non-Chip memory that resides on the local 32-bit 68030 processor bus. This memory is generally used for program code execution. The Fast RAM is tightly coupled to the 68030 via custom circuitry that has been designed to provide very efficient operation. This allows programs to execute very quickly from this RAM.

The standard A3000 is shipped with 1 megabyte of Fast RAM. (Other models may provide more RAM.) The organization of the RAM chips is $256\text{K} \times 4$. A total of 32 RAM chips can be installed in the Fast RAM section. Using $256\text{K} \times 4$ DRAMS, this results in a total of 4 megabytes of Fast RAM. The A3000 also supports the use of DRAMs organized as 1 megabit \times 4 ($1\text{M} \times 4$). If all 32 of the RAM locations are populated with $1\text{M} \times 4$ DRAMS, the total amount of Fast RAM is 16 megabytes.

WARNING: $256\text{K} \times 4$ and $1\text{M} \times 4$ DRAMS CANNOT be intermixed in the Fast RAM section! If the first bank has $256\text{K} \times 4$ DRAMS, then subsequent banks must have $256\text{K} \times 4$ DRAMS as well. If the first bank has $1\text{M} \times 4$ DRAMS, then the other banks also must have $1\text{M} \times 4$ DRAMS.

There are four *banks* of Fast memory that can be filled. Each bank consists of 8 RAM chips. Using $256K \times 4$ DRAMs, each bank adds 1 megabyte. With $1M \times 4$ DRAMs, each bank adds 4 megabytes. Bank 0 consists of locations labeled as U850-U857, bank 1 U858-U865, bank 2 U866-U873 and bank 3 U874-U881. Fast RAM **MUST** begin in bank 0, and is added to banks 1 through 3 in sequence.

The Fast RAM section of the motherboard is shown in the illustration on page 4-22. This section consists of 8 20-pin DIP sockets (U850D-U857D), as well as 32 20-pin ZIP sockets (U850-U881). As stated earlier, a maximum of 32 of these locations may be populated with RAM chips. The 8 DIP locations and the 8 lowest numbered ZIP locations are electrically equivalent (both are bank 0). RAM chips can be installed in either the DIP section **OR** the first bank in the ZIP section, but not both.

Two types of RAM sockets (DIP and ZIP) are provided for RAM bank 0 to allow for greater flexibility in arranging the RAM to suit your needs. The 1 megabyte of Fast RAM that is shipped in the A3000 is supplied in the form of DIP DRAMs in locations labeled as U850D through U857D. This allows the RAM chips from these sockets to be removed and added to the Chip RAM section of the board (Chip RAM accepts only DIP DRAMs) if you purchase more Fast RAM.

In the Fast RAM section, the use of static column mode DRAMs allows for improved system performance. It is therefore recommended that this type of DRAM be used when upgrading the system. In order to take advantage of static column mode DRAMs, ALL of the Fast RAM must be static column mode DRAMs.

NOTE: Static Column and Page Mode RAM should not be mixed in the Fast RAM section. The 1MB DIP-package RAM supplied in the standard configuration may be either type, depending on availability at the time your A3000 was assembled.

There is one jumper (J852) that is associated with the Fast RAM. When using 256K × 4 DRAMs, pins 2 and 3 of this jumper should be connected. If the Fast RAM section contains only 1M × 4 DRAMs, then pins 1 and 2 should be connected.

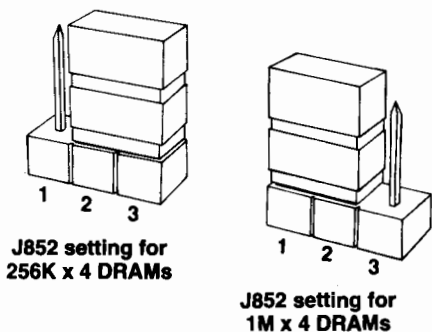

If the new RAM is functioning properly it will automatically be recognized by the operating system when the A3000 is powered up. The title bar of the Workbench screen (which shows how much "other" memory is available to the system)

should indicate the addition of the new memory. If this number does not reflect the expected amount of Fast RAM, then there is a problem. Check that the RAM chips were inserted properly, and check for any bent pins. (Note that installing a memory chip backwards may very likely destroy the chip.)

The following is a list of required parameters for the new Fast RAM:

- Organization:** 256 kilobits by 4 bits (256K × 4)
- or
- 1 megabit by 4 bits (1M × 4)
- Speed:** 80 nanoseconds or less
- Type:** page or static column mode
- Package:** 20-pin DIP (Bank 0, U850D-U857D only)
- 20-pin ZIP

The following are examples of acceptable DRAMs:

<i>256K × 4 Page Mode</i>		<i>256K × 4 Static Column Mode</i>	
TOSHIBA	TC514256	TOSHIBA	TC514258
OKI	MSM514256	SHARP	LH64258
HITACHI	HM514256	OKI	MSM514258
NEC	μPD424256	HITACHI	HM514258
		NEC	μPD424258
		TI	TMS44C258
 <i>1M × 4 Page Mode</i>		 <i>1M × 4 Static Column Mode</i>	
TOSHIBA	TC514400	TOSHIBA	TC514402
HITACHI	HM514400	OKI	MSM514402
NEC	μPD424400		
OKI	MSM514400		

The RAM part numbers listed DO NOT include the package type information (ZIP or DIP). Therefore, you must specify the package type you want when ordering these DRAMs (package types will be suffixes to the part numbers listed).

Here are some examples of the options available when adding Fast RAM:

1. Leave the DIP DRAMs in bank 0 and add additional 256K \times 4 ZIP DRAMs in banks 1 through 3.
2. Move the DIP DRAMs in bank 0 to the CHIP RAM section and add additional 256K \times 4 ZIP DRAMs in banks 0 through 3.
3. Move the DIP DRAMs in bank 0 to the CHIP RAM section and add 1M \times 4 ZIP DRAMs in banks 0 through 3.
4. Move the DIP DRAMs in bank 0 to the CHIP RAM section and add 1M \times 4 DIP DRAMs in bank 0 and 1M \times 4 ZIP DRAMs in banks 1 through 3.

Chip Memory

Chip memory (also known as Chip RAM) stores graphics, sound and other data that is accessible by the Amiga custom chips. Certain software requiring large amounts of this type of data, or many programs executing concurrently that require this type of data, can quickly exhaust the one megabyte of Chip RAM that comes in the A3000 as shipped. Another megabyte of Chip RAM can be added. (See the motherboard illustration on page 4-22 for the location of the Chip RAM.) When adding Chip RAM, all eight of the empty sockets (U267-U274) must be populated with the new RAM chips.

There are no jumpers to set when adding Chip RAM. If the new Chip RAM is functioning properly (a memory test will be performed at power up), it will automatically be recognized by the operating system. The title bar of the Workbench screen

(which shows how much "graphics" memory is available to the system) should reflect the addition of the new memory. If this number is not approximately 1 megabyte larger than it was when the machine was operated without the new Chip RAM, then the RAM is not working properly. Also, if the video screen turns green when the A3000 is turned on, then none of the Chip RAM is functioning properly. In either case, check that the RAM chips were inserted properly, and check for any bent pins.

The following is a list of required parameters for the new Chip RAM:

Organization:	256 kilobits by 4 bits (256K × 4)
Speed:	120 nanoseconds or less
Type:	page or static column mode
Package:	20-pin DIP

The following are examples of some of the DRAMs that are acceptable:

TOSHIBA	TC514256 TC514258
OKI	MSM514256 MSM514258
HITACHI	HM514256 HM514258
NEC	μPD424256 μPD424258
SHARP	LH64258
TI	TMS44C256

The RAM part numbers listed DO NOT include the package type information (ZIP or DIP). Therefore, you must specify the package type you want when ordering these DRAMs (package types will be suffixes to the part numbers listed).

Installing Chip RAM

1. Install in empty sockets U267-U274. *All eight sockets must be populated.*

See page 4-22 for location of CHIP RAM sockets.

NOTE: Pin 1 of the chip should be facing the rear of the A3000.

Installing FAST RAM

1. Remove S clip at top center of daughterboard.
2. Left daughterboard up and out.
3. Remove spacer.
4. Remove S clips from left and right sides of backplane. (Be sure to save the S clips and reinstall them when reassembling the A3000.)

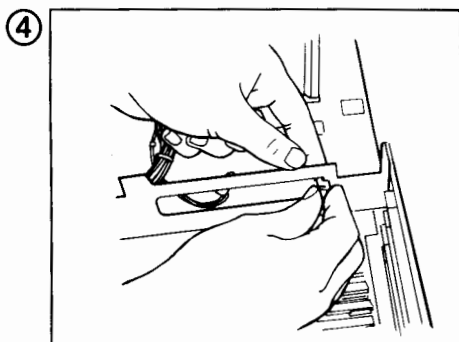
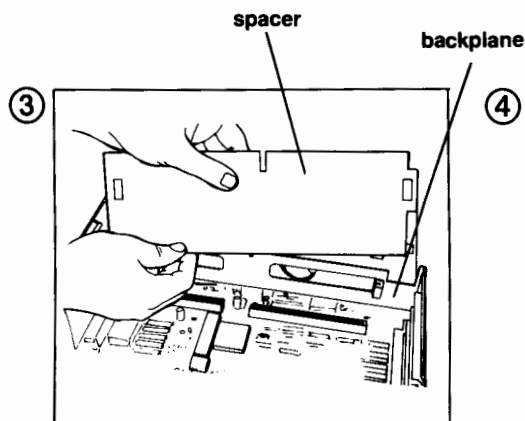
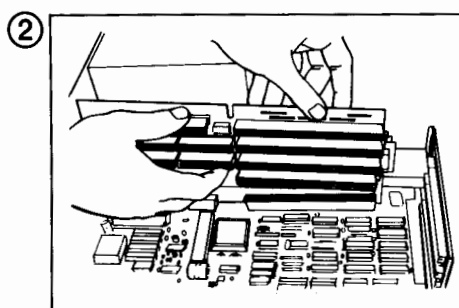
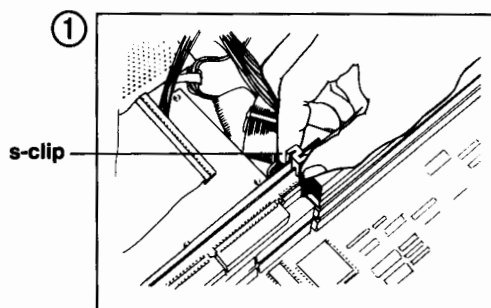

(cont'd)

Installing FAST RAM (cont'd)

5. Remove screws holding platform.
6. Lift platform.
7. Disconnect ribbon cables from motherboard.
8. Disconnect power supply connector from motherboard.
(Note that the connector is secured by a clamp.)

Insert the RAM chips per the instructions on pages 4-14 through 4-18. Set Jumper J852 for the RAM type installed, per the instructions on page 4-16.

NOTE: When installing ZIP chips, pin 1 of the chip should be at the left as you are facing the front of the A3000. See the illustration of the ZIP chip on page 4-22.

screw for hard drive mounting plate

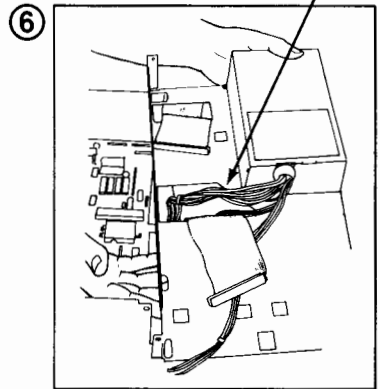
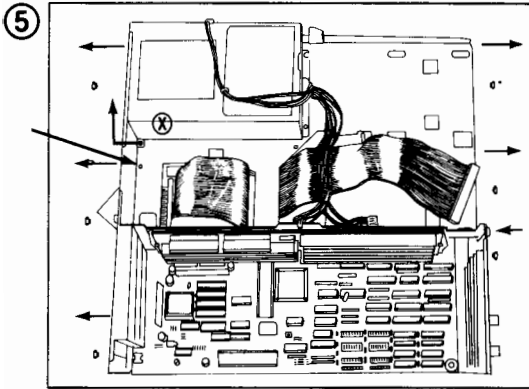

NOTE: To help identify screw locations, Drawing 5 above shows the hard and floppy drives removed. When removing the center front screw, which secures both the floppy drive and the platform, hold the floppy drive firmly. To remove the screw marked ⊗, located on the platform behind the hard disk, first remove the rear screws. Then lift the ribbon cable at the rear of the hard drive to gain access to the screw.

Note orientation of cables before disconnecting, especially the location of pin 1; see pages 4-11/4-12.

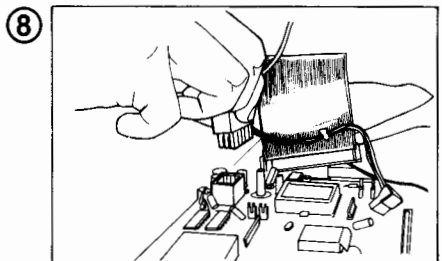
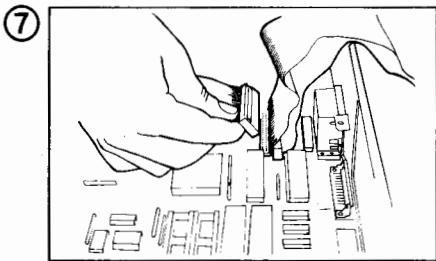

Location of RAM Sockets on Motherboard

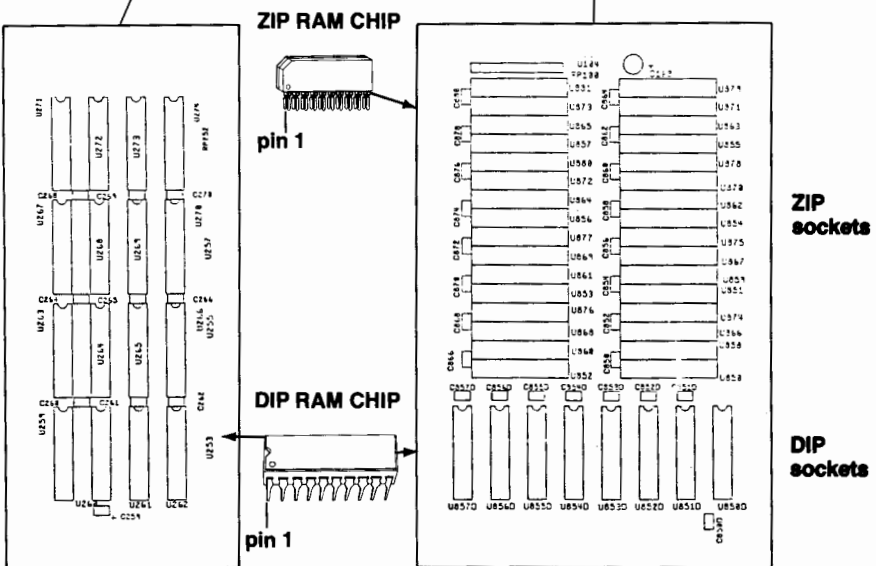
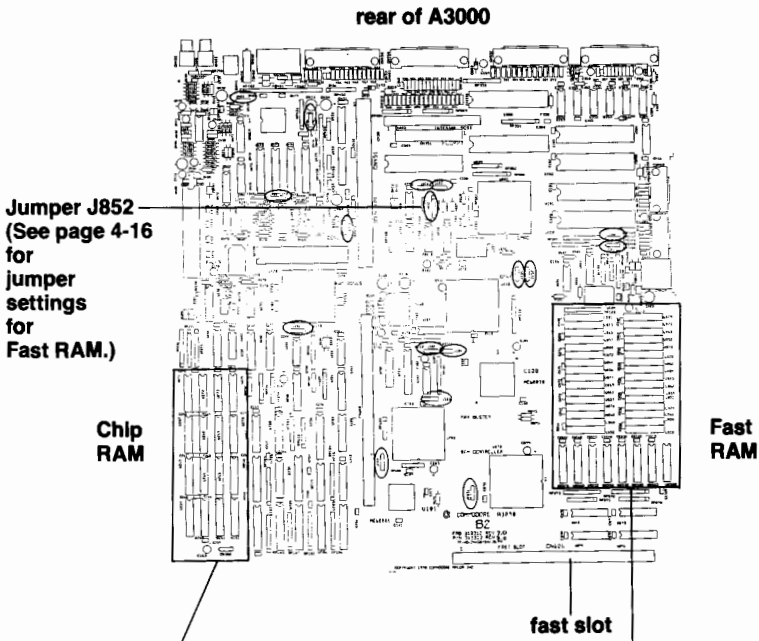

Connecting Additional SCSI Devices

You can connect up to seven DMA SCSI devices to the A3000, using the internal SCSI connector and the connector marked SCSI PORT on the rear of the A3000.

When connecting external SCSI devices, gently insert the connector of the first device into the A3000's external SCSI PORT and secure the screws. The SCSI device will require its own power supply. Additional SCSI devices can be connected in a daisy-chain. (The first peripheral device connects to the A3000, the second device connects to the first device, etc.)

Use the existing 50-pin ribbon cable to connect internal SCSI devices. Each internal SCSI device must also be connected to the internal power supply.

Each SCSI device must be set to a different SCSI address. Note that the A3000 SCSI controller is set to SCSI address 7 and the internal hard drive is set to SCSI address 6. Addresses 0 through 5 are available for additional SCSI devices.

If multiple SCSI hard disks are connected to the A3000, you will need to remove the terminator packs on all but the last external SCSI device in the chain, and all but the last internal SCSI device in the chain. Refer to the manufacturer's documentation for the location of the terminator packs on each device.

For information on jumper settings for SCSI drives refer to Appendix G.

Appendices

Appendix A

Technical Specifications

CPU:	Motorola 68030, 32 Bit
Clock Speed:	25 MHz or 16 MHz
Coprocessors:	Numeric coprocessor, either 68881 (16 MHz) or 68882 (25 MHz) Multi-chip coprocessor system for DMA video, graphics and sound
Memory:	2 MB RAM standard (1 MB Chip, 1 MB Fast); expandable on motherboard up to a total of 18 MB (2 MB Chip, 16 MB Fast); additional RAM can be added via expansion slots
ROM:	512 KB
Interfaces:	<i>External:</i> Keyboard Mouse/Joystick (2) Serial (RS232, PC-compatible) Parallel (Centronics, PC-compatible) 2 Video (DB23 15 KHz: RGB analog; VGA DB15 31 KHz: Multiscanning compatible RGB analog) SCSI Stereo Audio <i>Internal:</i> Amiga System Bus: 4 slots (100 pin)— Zorro II & III Secondary Bus System: Two slots PC/AT-compatible (full size, 86-pin) (slots are in line with Amiga 100-pin slots)

	One 200-pin Fast slot (local 68030 bus) for 68040, etc. SCSI
Video Slot:	1 video slot for internal video cards; in line with 100-pin Amiga slot
Power Supply:	Switching, 135 watts, with dual-speed thermostat-controlled fan
Keyboard:	Detachable, 94 keys U.S./96 keys international
Disk Drive(s):	Standard: built-in 3.5-inch floppy drive (capacity: 880 KB formatted) Internal mounting locations for three 3.5 inch half-height drives (two already used) Built-in SCSI hard drive Built-in DMA SCSI controller; supports up to 7 SCSI devices
External Disk Drives:	Up to 2 optional Amiga-compatible floppy disk drives
Video Display:	Complies with: North America: RGB NTSC International: RGB PAL 4096 Colors
Display Enhancer:	See Appendix C
Environmental Specification:	Operating: 0-45°C (32 to 113°F) Storage/Shipping: 0-60°C (32 to 140°F)

MTBF
(Mean Time
Between
Failure)

1.86 year

Sound:

4 independent sound channels configured as
two stereo channels

Text-to-speech
conversion:

Built-in

Clock/Calendar: Built-in, with battery back-up

System Software: Multitasking; includes AmigaDOS,
Workbench, and various utilities

Appendix B

Input/Output Connector Pin Assignments

This section lists pin assignments for input/output connectors on the A3000. The information in this section is highly technical and is intended only for those expert in connecting external devices to computers. You do not need this information if you use a cable specifically designed for the A3000 and the peripheral you want to connect.

If you attach peripherals with cables other than those designed for use with the A3000, note: some pins on Amiga connectors provide power outputs and non-standard signals. Attempting to use cables not wired specifically for the Amiga may cause damage to the Amiga or to the equipment you connect. The descriptions that follow include specific warnings for each connector. For more information about connecting peripherals, consult your Amiga dealer.

In the descriptions that follow, a horizontal line over the signal name indicates a signal that is *active low* (e.g., $\overline{\text{STROBE}}$). -

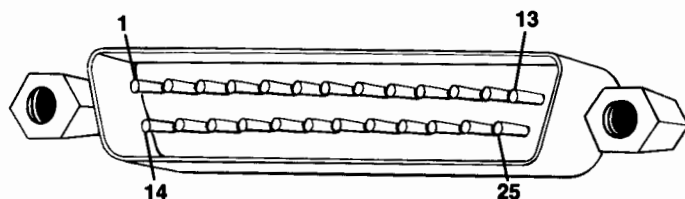
Serial Connector—DB25 Male (SERIAL PORT)

In the following table, the second column from the left gives the Amiga pin assignments. The third and fourth columns from the left give pin assignments for other commonly used connections; the information in these two columns is given for comparison only.

WARNING: Pins 9 and 10 on the Amiga serial connector are used for external power. Connect these pins ONLY if power from them is required by the external device. The table lists the power provided by each of these pins.

Pin	A3000	RS232	HAYES®	Description
1	SHIELD	GND	GND	Shield Ground
2	TXD	TXD	TXD	Transmit Data
3	RXD	RXD	RXD	Receive Data
4	RTS	RTS		Request to Send
5	CTS	CTS	CTS	Clear to Send
6	DSR	DSR	DSR	Data Set Ready
7	GND	GND	GND	System Ground
8	DCD	DCD	DCD	Carrier Detect
9	+12V			+ 12 Volts DC
10	-12V			- 12 Volt DC
11	AUDO			Audio out of A3000
12		S.SD	SI	Speed Indicate
13		S.CTS		
14		S.TXD		
15		TXC		
16		S.RXD		
17		RXC		
18	AUDI			Audio into A3000
19		S.RTS		
20	DTR	DTR	DTR	Data Terminal Ready
21		SQD		
22	RI	RI	RI	Ring Indicator
23		SS		
24		TXC1		
25				

Parallel Connector—DB25 Female (PARALLEL PORT)

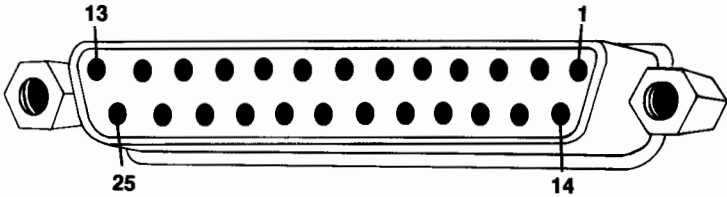

WARNING: Pin 14 on the Amiga parallel connector supplies +5 volts of power. Connect this pin **ONLY** if the power from it is required by the external device. **NEVER** connect this pin to an output of an external device or to a signal ground. Pins 17-25 are for grounding signals. **DO NOT** connect these pins directly to a shield ground.

Pin	Name	Description
1	<u>STROBE</u>	Strobe
2	D0	Data Bit 0 (LSB)
3	D1	Data Bit 1
4	D2	Data Bit 2
5	D3	Data Bit 3
6	D4	Data Bit 4
7	D5	Data Bit 5
8	D6	Data Bit 6
9	<u>D7</u>	Data Bit 7 (MSB)
10	<u>ACK</u>	Acknowledge
11	BUSY	Busy
12	POUT	Paper Out
13	SEL	Select
14	+5V PULLUP	+5 Volts DC (10 mA)
15		Not Used
16	<u>RESET</u>	Reset
17	GND	Signal Ground
18	GND	Signal Ground
19	GND	Signal Ground
20	GND	Signal Ground
21	GND	Signal Ground
22	GND	Signal Ground
23	GND	Signal Ground
24	GND	Signal Ground
25	GND	Signal Ground

RGB Monitor Connector-DB23 Male (15 KHz VIDEO PORT)

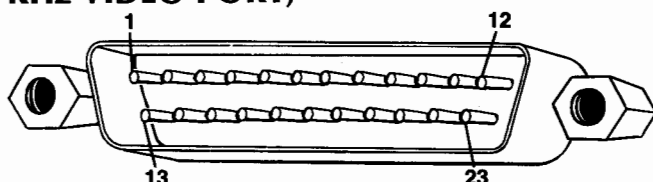

WARNING: Pins 21, 22 and 23 on the RGB monitor connector are used for external power. Connect these pins **ONLY** if power from them is required by the external device. The table below lists the power provided by each of these pins.

Pin	Name	Description
1	\overline{XCLK}	External Clock
2	\overline{XCLKEN}	External Clock Enable
3	RED	Analog Red
4	GREEN	Analog Green
5	BLUE	Analog Blue
6	DI	Digital Intensity (47 Ohm)
7	DB	Digital Blue (47 Ohm)
8	DG	Digital Green (47 Ohm)
9	DR	Digital Red (47 Ohm)
10	\overline{CSYNC}	Composite Sync
11	\overline{HSYNC}	Horizontal Sync (47 Ohm)
12	\overline{VSYNC}	Vertical Sync (47 Ohm)
13	GNDRTN	Return for \overline{XCLKEN}
14	\overline{ZD}	Zero Detect (47 Ohm)
15	\overline{CI}	Clock Out
16	GND	Ground
17	GND	Ground
18	GND	Ground
19	GND	Ground
20	GND	Ground
21	-12V	- 5 Volts DC (50 mA)
22	+12V	+ 12 Volts DC (100 mA)
23	+5V	+ 5 Volts DC (100 mA)



**Display Enhancer Video Connector-VGA DB15
Female (31 KHz VIDEO PORT)**

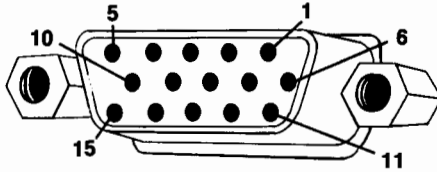

Pin	Description
1	Red Video
2	Green Video
3	Blue Video
4	Monitor Id Bit 2 (Ground)
5	Ground
6	Red Return (Ground)
7	Green Return (Ground)
8	Blue Return (Ground)
9	Key (Not Used)
10	Sync Return (Ground)
11	Monitor ID Bit 0 (Ground)
12	Monitor ID Bit 1 (Ground)
13	Horizontal Sync
14	Vertical Sync
15	Not Used

Mouse/Game Controller Connectors—DB9 Male (MOUSE PORTS)

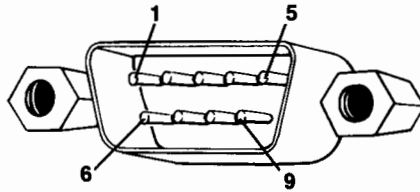

If you use a mouse to control the Workbench, you must attach it to mouse connector 1 (the front mouse connector on the right side of the A3000). You can attach joystick controllers and light pens to either of the connectors. The following tables describe mouse, game controller, and light pen connections.

WARNING: Pin 7 on each of these connectors supplies +5 volts of power. Connect this pin **ONLY** if power from it is required by the external device.

Connector 1: Mouse

Pin	Name	Description
1	MOUSE V	Mouse Vertical
2	MOUSE H	Mouse Horizontal
3	MOUSE VQ	Vertical Quadrature
4	MOUSE HQ	Horizontal Quadrature
5	MOUSE BUTTON 2	Mouse Button 2
6	MOUSE BUTTON 1	Mouse Button 1
7	+5V	+5 Volts DC (100 mA)
8	GND	Ground
9	MOUSE BUTTON 3	Mouse Button 3

Connectors 1 and 2: Game Controller (Joystick)

Pin	Name	Description
1	<u>FORWARD</u>	Controller Forward
2	<u>BACK</u>	Controller Back
3	<u>LEFT</u>	Controller Left
4	<u>RIGHT</u>	Controller Right
5	<u>POT X</u>	Horizontal Potentiometer
6	<u>FIRE</u>	Controller Fire
7	+5V	+5 Volts DC (100 mA)
8	GND	Ground
9	POT Y	Vertical Potentiometer

Connectors 1 and 2: Light Pen

Pin	Name	Description
1		Not Used
2		Not Used
3		Not Used
4		Not Used
5	<u>LIGHT PEN PRESS</u>	Light Pen Switch
6	<u>LIGHT PEN</u>	Capture Beam Position
7	+5V	+5 Volts DC (100 mA)
8	GND	Ground
9		Not Used

**External Disk Connector—DB23 Female
(FLOPPY DISK DRIVE PORT)**

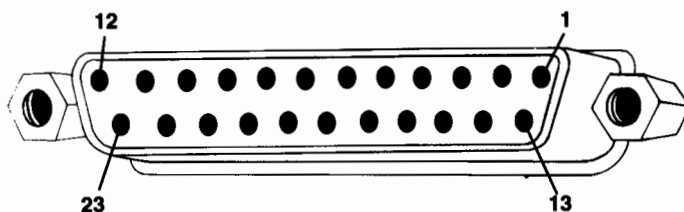

Pin	Name	Description
1	<u>RDY</u>	Disk Ready
2	<u>DKRD</u>	Disk Ready Data
3-7	<u>GND</u>	Ground
8	<u>MTRXD</u>	Disk Motor Control
9	<u>SEL3B</u>	Select Drive 3
10	<u>DRESB</u>	Disk Reset
11	<u>CHNG</u>	Disk Has Been Removed From Drive— Latched Low
12	<u>+5V</u>	+ 5 Volts DC
13	<u>SIDEB</u>	Select Disk Side—0 = Upper, 1 = Lower
14	<u>WPRO</u>	Disk Is Write Protected
15	<u>TK0</u>	Drive Head Position Over Track 0
16	<u>DKWE</u>	Disk Write Enable
17	<u>DKWD</u>	Disk Write Data
18	<u>STEPB</u>	Step The Head—Pulse, First Low, Then High
19	<u>DIRB</u>	Select Head Direction— 0 = Inner, 1 = Outer
20	<u>SEL1B</u>	Select Drive 1
21	<u>SEL2B</u>	Select Drive 2
22	<u>INDEX</u>	Disk Index Pulse
23	<u>+12V</u>	+ 12 Volts DC

External SCSI Connector—DB25 Female (SCSI PORT)

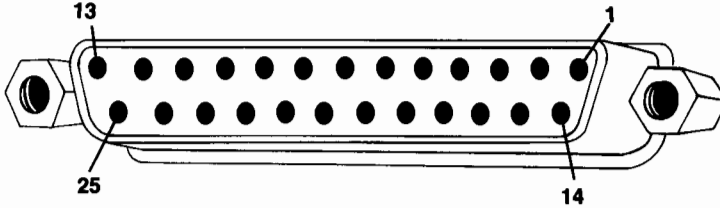

Pin	Description
1	<u>REQ</u>
2	<u>MSG</u>
3	<u>I/O</u>
4	<u>RST</u>
5	<u>ACK</u>
6	<u>BSY</u>
7	Ground
8	Data 0 (LSB)
9	Ground
10	Data 3
11	Data 5
12	Data 6
13	Data 7 (MSB)
14	Ground
15	<u>C/D</u>
16	Ground
17	<u>ATN</u>
18	Ground
19	<u>SEL</u>
20	Parity
21	Data 1
22	Data 2
23	Data 4
24	Ground
25	Termination Power

Internal SCSI Connector (MOTHERBOARD)

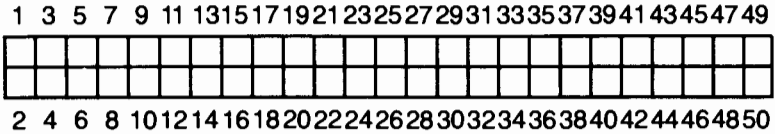

Pin	Description
2	Data 0 (LSB)
4	Data 1
6	Data 2
8	Data 3
10	Data 4
12	Data 5
14	Data 6
16	Data 7 (MSB)
18	Parity
20	Ground
22	Ground
24	Ground
26	Termination Power
28	Ground
30	Ground
32	ATN
34	Not Used
36	BSY
38	ACK
40	RST
42	MSG
44	SEL
46	C/D
48	REQ
50	I/O

All odd pins, except pin 25, are ground. Pin 25 is not used.

100 Pin Expansion Slot

Pin	Physical Name	Zorro II Name	Zorro III Address Phase	Zorro III Data Phase
1	Ground	Ground	Ground	Ground
2	Ground	Ground	Ground	Ground
3	Ground	Ground	Ground	Ground
4	Ground	Ground	Ground	Ground
5	+5VDC	+5VDC	+5VDC	+5VDC
6	+5VDC	+5VDC	+5VDC	+5VDC
7	$\overline{\text{OWN}}$	$\overline{\text{OWN}}$	$\overline{\text{OWN}}$	$\overline{\text{OWN}}$
8	-5VDC	-5VDC	-5VDC	-5VDC
9	$\overline{\text{SLAVEN}}$	$\overline{\text{SLAVEN}}$	$\overline{\text{SLAVEN}}$	$\overline{\text{SLAVEN}}$
10	+12VDC	+12VDC	+12VDC	+12VDC
11	$\overline{\text{CFGOUTN}}$	$\overline{\text{CFGOUTN}}$	$\overline{\text{CFGOUTN}}$	$\overline{\text{CFGOUTN}}$
12	$\overline{\text{CFGINN}}$	$\overline{\text{CFGINN}}$	$\overline{\text{CFGINN}}$	$\overline{\text{CFGINN}}$
13	Ground	Ground	Ground	Ground
14	$\overline{\text{C3}}$	$\overline{\text{C3}}$ Clock	$\overline{\text{C3}}$ Clock	$\overline{\text{C3}}$ Clock
15	CDAC	CDAC Clock	CDAC Clock	CDAC Clock
16	$\overline{\text{C1}}$	$\overline{\text{C1}}$ Clock	$\overline{\text{C1}}$ Clock	$\overline{\text{C1}}$ Clock
17	$\overline{\text{CINH}}$	$\overline{\text{OVR}}$	$\overline{\text{CINH}}$	$\overline{\text{CINH}}$
18	$\overline{\text{MTCR}}$	$\overline{\text{XRDY}}$	$\overline{\text{MTCR}}$	$\overline{\text{MTCR}}$
19	$\overline{\text{INT2}}$	$\overline{\text{INT2}}$	$\overline{\text{INT2}}$	$\overline{\text{INT2}}$
20	-12VDC	-12VDC	-12VDC	-12VDC
21	A5	A5	A5	A5

100 Pin Expansion Slot (cont'd.)

Pin	Physical Name	Zorro II Name	Zorro III Address Phase	Zorro III Data Phase
22	$\overline{\text{INT6}}$	$\overline{\text{INT6}}$	$\overline{\text{INT6}}$	$\overline{\text{INT6}}$
23	A6	A6	A6	A6
24	A4	A4	A4	A4
25	Ground	Ground	Ground	Ground
26	A3	A3	A3	A3
27	A2	A2	A2	A2
28	A7	A7	A7	A7
29	$\overline{\text{LOCK}}$	A1	$\overline{\text{LOCK}}$	$\overline{\text{LOCK}}$
30	AD8	A8	A8	D0
31	FC0	FC0	FC0	FC0
32	AD9	A9	A9	D1
33	FC1	FC1	FC1	FC1
34	AD10	AD10	AD10	AD2
35	FC2	FC2	FC2	FC2
36	AD11	A11	A11	D3
37	Ground	Ground	Ground	Ground
38	AD12	A12	A12	D4
39	AD13	A13	A13	D5
40	$\overline{\text{INT7}}$	$\overline{(\text{EINT7})}$	$\overline{\text{INT7}}$	$\overline{\text{INT7}}$
41	AD14	A14	A14	D6
42	$\overline{\text{INT5}}$	$\overline{(\text{EINT5})}$	$\overline{\text{INT5}}$	$\overline{\text{INT5}}$

100 Pin Expansion Slot (cont'd.)

Pin	Physical Name	Zorro II Name	Zorro III Address Phase	Zorro III Data Phase
43	AD15	A15	A15	D7
44	$\overline{\text{INT4}}$	$\overline{(\text{EINT4})}$	$\overline{\text{INT4}}$	$\overline{\text{INT4}}$
45	AD16	A16	A16	D8
46	$\overline{\text{BERR}}$	$\overline{\text{BERR}}$	$\overline{\text{BERR}}$	$\overline{\text{BERR}}$
47	AD17	A17	A17	D9
48	$\overline{\text{MTACK}}$	$\overline{(\text{VPA})}$	$\overline{\text{MTACK}}$	$\overline{\text{MTACK}}$
49	Ground	Ground	Ground	Ground
50	E Clock	E Clock	E Clock	E Clock
51	$\overline{\text{DS0}}$	$\overline{(\text{VMA})}$	$\overline{\text{DS0}}$	$\overline{\text{DS0}}$
52	AD18	A18	A18	D10
53	$\overline{\text{RESET}}$	$\overline{\text{RST}}$	$\overline{\text{RESET}}$	$\overline{\text{RESET}}$
54	AD19	A19	A19	D11
55	$\overline{\text{HLT}}$	$\overline{\text{HLT}}$	$\overline{\text{HLT}}$	$\overline{\text{HLT}}$
56	AD20	A20	A20	D12
57	AD22	A22	A22	D14
58	AD21	A21	A21	D13
59	AD23	A23	A23	D15
60	$\overline{\text{BRN}}$	$\overline{\text{BRN}}$	$\overline{\text{BRN}}$	$\overline{\text{BRN}}$
61	Ground	Ground	Ground	Ground
62	$\overline{\text{BGACK}}$	$\overline{\text{BGACK}}$	$\overline{\text{BGACK}}$	$\overline{\text{BGACK}}$
63	AD31	D15	A31	D31
64	$\overline{\text{BGN}}$	$\overline{\text{BGN}}$	$\overline{\text{BGN}}$	$\overline{\text{BGN}}$

100 Pin Expansion Slot (cont'd)

Pin	Physical Name	Zorro II Name	Zorro III Address Phase	Zorro III Data Phase
65	AD30	D14	A30	D30
66	$\overline{\text{DTACK}}$	$\overline{\text{DTACK}}$	$\overline{\text{DTACK}}$	$\overline{\text{DTACK}}$
67	AD29	D13	A29	D29
68	READ	READ	READ	READ
69	AD28	D12	A28	D28
70	$\overline{\text{DS2}}$	$\overline{\text{LDS}}$	$\overline{\text{DS2}}$	$\overline{\text{DS2}}$
71	AD27	D11	A27	D27
72	$\overline{\text{DS3}}$	$\overline{\text{UDS}}$	$\overline{\text{DS3}}$	$\overline{\text{DS3}}$
73	Ground	Ground	Ground	Ground
74	$\overline{\text{CCS}}$	$\overline{\text{AS}}$	$\overline{\text{CCS}}$	$\overline{\text{CCS}}$
75	SD0	D0	N/A*	D16
76	AD26	D10	A26	D26
77	SD1	D1	N/A*	D17
78	AD25	D9	A25	D25
79	SD2	D2	N/A*	D18
80	AD24	D8	A24	D24
81	SD3	D3	N/A*	D19
82	SD7	D7	N/A*	D23
83	SD4	D4	N/A*	D20
84	SD6	D8	N/A*	D22
85	Ground	Ground	Ground	Ground

*N/A = Not applicable to this phase.

100 Pin Expansion Slot (cont'd)

Pin	Physical Name	Zorro II Name	Zorro III Address Phase	Zorro III Data Phase
86	SD5	D5	N/A	D21
87	Ground	Ground	Ground	Ground
88	Ground	Ground	Ground	Ground
89	Ground	Ground	Ground	Ground
90	Ground	Ground	Ground	Ground
91	SenseZ3	Ground	SenseZ3	SenseZ3
92	7M	E7M	7M	7M
93	DOE	DOE	DOE	DOE
94	$\overline{\text{IORST}}$	$\overline{\text{BUSRST}}$	$\overline{\text{IORST}}$	$\overline{\text{IORST}}$
95	$\overline{\text{BCLR}}$	$\overline{\text{GBG}}$	$\overline{\text{BCLR}}$	$\overline{\text{BCLR}}$
96	$\overline{\text{INT1}}$	$\overline{(\text{EINT1})}$	$\overline{\text{INT1}}$	$\overline{\text{INT1}}$
97	$\overline{\text{FCS}}$	Not Used	$\overline{\text{FCS}}$	$\overline{\text{FCS}}$
98	$\overline{\text{DS1}}$	Not Used	$\overline{\text{DS1}}$	$\overline{\text{DS1}}$
99	Ground	Ground	Ground	Ground
100	Ground	Ground	Ground	Ground

*N/A = Not applicable to this phase.

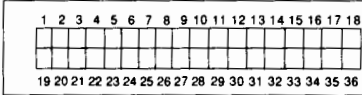
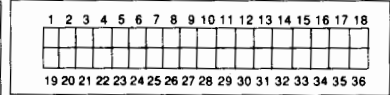
Video Slot**standard video slot****extended video slot**

Pin	Signal	Pin	Signal
1	Reserved for Expansion	2	Reserved for Expansion
3	Left Audio Out	4	Right Audio Out
5	Reserved for Expansion	6	+5 Volts DC
7	Analog Red	8	+5 Volts DC
9	Video Ground	10	+12 Volts DC
11	Analog Green	12	<u>Video Ground</u>
13	Video Ground	14	<u>CSYNC</u>
15	Analog Blue	16	<u>XCLKEN</u>
17	<u>Video Ground</u>	18	Burst Gate
19	<u>C4 CLOCK</u>	20	Video Ground
21	Video Ground	22	<u>H SYNC</u> (47 Ohm)
23	B0 = DI	24	<u>Video Ground</u>
25	B3 = DB	26	<u>VS SYNC</u> (47 Ohm)
27	G3 = DG	28	Comp Sync (Analog)
29	R3 = DR	30	<u>PIXELSW</u> (47 Ohm)
31	-5 Volts DC	32	<u>Video Ground</u>
33	XCLK	34	<u>CI CLOCK</u>
35	-5 Volts DC	36	Strobe

Extended Video Slot

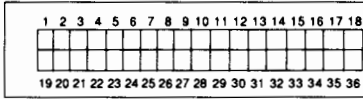

standard video slot

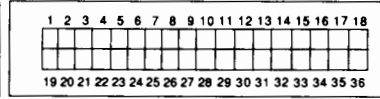

extended video slot

Pin	Signal	Pin	Signal
1	Ground	2	R0
3	R1	4	R2
5	Ground	6	G0
7	G1	8	G2
9	Ground	10	B1
11	B2	12	Ground
13	Monochrome Video	14	TBASE
15	CDAC Clock	16	POUT
17	$\overline{\text{C3 CLOCK}}$	18	$\overline{\text{Busy}}$
19	$\overline{\text{LPEN}}$	20	$\overline{\text{ACK}}$
21	SEL	22	Ground
23	PD0 (LSB)	24	PD1
25	PD2	26	PD3
27	PD4	28	PD5
29	PD6	30	PD7 (MSB)
31	$\overline{\text{LED}}$	32	Ground
33	Raw Audio Left	34	Audio Ground
35	Raw Audio Right	36	Audio Ground

Appendix C

Using the Display Enhancer

Introduction

The A3000 includes special video display circuitry known as the *Display Enhancer*. The Display Enhancer removes flicker and visible scan lines from most interlaced and noninterlaced graphics modes.

The Display Enhancer is software-compatible with existing software and internal Amiga plug-in cards, as well as the new ECS *Productivity* and *Superhires* modes available with the new Enhanced Denise chip and AmigaDOS 2.0. The Display Enhancer can be used simultaneously with many external and internal genlocks. The Display Enhancer significantly augments the graphics presentation capabilities of the Amiga 3000.

Display Enhancer Main Features

- Compatible with both NTSC (NTSC-M) and PAL (PAL-B, PAL-G, PAL-H) Amiga video formats. (Note: NTSC is the video standard that is used throughout most of North America, parts of Latin America and Japan. PAL is the video standard that is used throughout Europe, Australia and New Zealand.)
- Employs de-interlacing in Amiga interlaced display modes to remove flicker and visible scan lines with full overscan support.
- Employs scan-doubling in Amiga noninterlaced display modes to remove visible scan lines without motion artifacts (ghost effects).
- Severe overscan support.
- Supports the new ECS display modes (such as Productivity mode) under AmigaDOS 2.0. The Display Enhancer automatically detects Productivity mode and bypasses the video data to the multiscan monitor.
- *Enable/Disable* mode switch allows bypassing of the Display Enhancer video for output of the original Amiga video to a multiscan VGA monitor. This is used to display the ECS Superhires mode (1280x200/256 or 1280x400/512) on the monitor.

- Display Enhancer output is not interfered with by many external and internal genlocks (NTSC or PAL), providing high-resolution, flicker-free display of Amiga-only (RGB) output.
- Transparent to software.
- Video output is compatible with standard VGA multiscan monitors.
- A standard female VGA DB15 connector is provided.
- An Amiga monitor (A1084, A1084S, A1080, A2002) or external composite encoder box (A520) can remain attached to the Amiga 's 23-pin RGB port, providing a standard video display.
- Fully supports the Amiga's 4096-color palette and HAM (hold-and-modify) modes.

Connecting a Multiscan Monitor

The Display Enhancer is compatible with standard VGA multiscan monitors (like the Commodore 1950 MULTISCAN Monitor), and provides a standard VGA DB15 female connector (marked **31 KHz**) for output to a multiscan monitor. For instructions on connecting a multiscan monitor see the *Amiga 3000 Quick Connect* booklet.

Operation and Compatibility

The Display Enhancer is capable of operation in many of the graphics modes available on the Amiga. In the noninterlaced Amiga modes (320x200/256, and 640x200/256), the Display Enhancer will automatically operate in Scan-double mode when the Display Enhancer mode switch is set to the *Enable* (DOWN) position. This means that the Display Enhancer repeats every line to increase the raster scan rate from 15.734 KHz NTSC (15.625 KHz PAL) to 31.46 KHz NTSC (31.25 KHz PAL). In this mode, the Display Enhancer removes visible scan lines and provides full overscan and HAM support, giving text and graphics a professional look. Another benefit of this mode is that there are no motion artifacts (i.e., shearing or ghosting effects with moving objects). This is of great value for animation and game software featuring rapid object animation.

Note: The mode switch is located on the rear of the A3000 main unit, next to the 31 KHz Video connector.

In the interlaced Amiga modes (320x400/512 and 640x400/512), the Display Enhancer automatically operates in Deinterlace mode when the mode switch is set to *Enable* (DOWN) position. Here, the Display Enhancer stores the previous video field and combines it with the current incoming video field to remove flicker and visible scan lines. The raster scan rate is doubled and provides full overscan and HAM support. In this mode you may notice some motion artifacts (i.e., ghosting effects) with fast-moving animated objects.

Another Amiga display mode, which uses the ECS (Enhanced Chip Set) supported under AmigaDOS 2.0, is *Productivity Mode*. This mode has a display of 640x480 with 4 colors out of a palette of 64, and a raster scan rate of 31.46 KHz. In this display mode, the Display Enhancer will automatically bypass the video data to the multiscan monitor, since the raster scan rate is already at 31.46 KHz and has no flicker or visible scan lines.

Still another Amiga display mode which uses the ECS under AmigaDOS 2.0 is *Superhires* mode. This mode has a display of either 1280x200/256 or 1280x400/512, with 4 colors out of a palette of 64, and a raster scan rate of 15.734 KHz NTSC (15.625 KHz PAL). In this mode the Display Enhancer only samples every other pixel and may cause a distorted display, so you should set the mode switch to the *Disable* (UP) position.

If you encounter a display mode that adversely affects the Display Enhancer, simply flip the mode switch UP to Disable mode. Whatever display the Amiga generates will be sent to the monitor as if the Display Enhancer were not in the system.

External/Internal Genlock Compatibility

The Display Enhancer is compatible with many external and internal NTSC and PAL genlocks, including the new genlock extensions supported in AmigaDOS 2.0.

To use the Display Enhancer with an *external* genlock, simply connect the genlock to the A3000's 23-pin video port (marked **15 KHz**), following the instructions given by the genlock's manufacturer.

To use the Display Enhancer with an *internal* genlock card, install the genlock card as instructed by the manufacturer.

After a genlock (internal or external) is connected or installed, set the Display Enhancer mode switch to the *Enable* (DOWN) position. The Display Enhancer will automatically provide a flicker-free high-resolution display of the A3000's computer-only output.

Once connected to the A3000, a genlock should normally provide Amiga graphics and video to the composite monitor or VCR connected to the genlock's video out connector.

If you experience any problems in obtaining a stable display, try adjusting the fine tuning control, using the technique described in the *Adjustment Procedure* section of this appendix. If this does not help, refer to the *Troubleshooting* section of this appendix. (Note that some genlocks require a stable input video source at all times to work correctly with the Amiga.)

If the problem remains even after you have followed the instructions in the *Adjustment Procedure* and *Troubleshooting* sections, then it is likely that your genlock is incompatible with the Display Enhancer. You can continue to use your genlock with the A3000, except that you will not be able to use the 31 KHz video output from the Display Enhancer to view your Amiga graphics display.

Adjusting the Display Enhancer Fine Tuning Control

There are two tuning adjustment controls for the Display Enhancer: *Fine* and *Coarse*. These controls have been factory preset to work with both NTSC- and PAL-based Amiga A3000s and should normally not require adjustment. The *Coarse* tuning control is not user adjustable; any adjustment must be performed by an authorized Commodore-Amiga service center. The *Fine* tuning control is user adjustable; if you are experiencing display problems such as pixel "jittering", follow the fine tuning adjustment procedure given in the next section.

Adjustment Procedure

NOTE: The following description assumes familiarity with standard Amiga operating features. If you need an explanation of any of these features, such as using the mouse to select an icon, see the tutorial material in Chapter 1 of the *Using the System Software* manual included with your A3000 computer.

To adjust the Display Enhancer fine tuning control, you must have already connected a multiscan monitor to the Display Enhancer 15-pin video output (marked **31 KHz**). Power on the monitor and then the A3000. Allow the A3000 to warm up for approximately five minutes. Activate the De-interlace/Scan-double mode of the Display Enhancer by flipping the mode switch **DOWN** to the *Enable* position. The display may look unusual and may have pixels "jittering," but it should otherwise be recognizable. The fine tuning adjustment will stabilize the display.

Locate the fine tuning control opening on the rear of the A3000, just next to the *Enable/Disable* mode switch. Position the monitor so that you will be able to see the screen while you are working at the rear of the A3000 with the plastic adjustment tool (the adjustment tool is the small, screwdriver-like tool supplied with the A3000; see the illustration below).

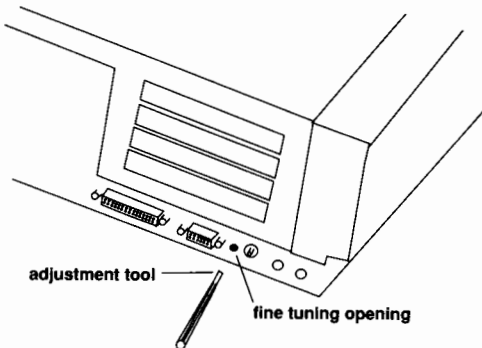

Open the Workbench2.0 *Prefs* drawer and double-click on the Screenmode icon. With the mouse, select the *SuperHires* video mode and click on the *Use* button. Your A3000 will then switch to the 1280 × 200/256 display mode. You should then flip the mode switch to the *Disable* (UP) position to put the Display Enhancer into Bypass mode. Double-click first on the *Tools* drawer and the *Video Adjust* drawer and then on the **Test3** icon to bring up a special test pattern window on your screen.

Now, insert the adjustment tool straight into the opening for the fine tuning control. Engage the tool in the screw slot. Slowly turn the fine tuning control clockwise or counterclockwise until all parts of the display are stable and are not jittering. This should occur in one to fifteen full turns of the fine tuning control screw. If you think that you have gone too far, turn the fine tuning control in the opposite direction. You may hear a slight clicking sound as you turn the fine tuning control. This indicates that the screw has reached the end of its travel, and you should turn the screw in the opposite direction.

When you have achieved the best image you can with the **Test3** program, double-click on the **Test1** icon. Flip the mode switch to *Enable* (DOWN) position and, using the adjustment tool, slowly turn the fine tuning control clockwise or counterclockwise until all parts of the **Test1** pattern are stable and are not jittering.

Click anywhere in the lower half of the image to bring up the title bar with the depth gadget in the upper right corner of the screen. Click on the depth gadget to bring up the Workbench screen; double-click on the **Test2** icon, and repeat the same adjustment procedure as with **Test1**. When the display is stable, use the depth gadget to return to the **Test1** pattern and check to make sure that it has not lost stability with the new fine tuning setting. Then return to the Disable mode (UP) and recheck the **Test3** pattern as well. Be sure to look closely at all the colors, lines, and patterns of all three images when adjusting the fine tuning control for a sharp and stable display. Once all test patterns appear satisfactory, adjustment is complete and you can return the mode switch to the Enable position (DOWN).

If after attempting to adjust the fine tuning control you are unable to obtain a stable display, please refer to the Troubleshooting section that follows. Once you have the Display Enhancer operating, you may need to adjust your monitor's size and position controls.

<p>NOTE: If the display at any time develops pixel jitter due to component aging, you can slightly adjust the fine tuning control to make the display stable again.</p>
--

Troubleshooting

If you are unable to produce a stable display, check the following:

1. Make sure the monitor you are using is a multiscan VGA-compatible monitor. Be sure that the monitor cable is correctly installed, and that the signal connections between your monitor and the A3000's 15-pin **31 KHz** video connector are correct. Also check that your cables are screwed tightly into the connectors at both ends, and that your monitor is set for the correct mode (analog, RGB, etc.).

2. Make sure that all external peripherals are properly connected to the A3000 and that their cables are screwed tightly into their connectors.
3. Make sure that the Display Enhancer mode switch is in the correct position for the fine tuning control adjustment. The mode switch should be flipped to the DOWN position (the Deinterlace/Scan-double *Enable* mode setting.).
4. Recheck your fine tuning, using the procedure described previously. You may need to make sure that you have turned the fine tuning control completely through the range of fifteen full turns and slowly back again in order to correctly fine tune the Display Enhancer.

NOTE: If you are still unable to properly adjust the Display Enhancer and obtain a stable display with your specific A3000/monitor setup, please contact your local authorized Commodore service center.

Display Enhancer Technical Specifications

- Horizontal Frequency:** NTSC—31.468 KHz unbypassed,
15.734 KHz bypassed
PAL—31.25 KHz unbypassed,
15.625 KHz bypassed
- Vertical Frequency:** NTSC—60 Hz
PAL—50 Hz
- Video Signal Outputs:** Analog, 0.7 V_{p-p}/75 Ohms, positive polarity
- Video Sync Signals:** Separate, TTL level, negative polarity
- Pixel Output:** NTSC—35ns wide, 910 pixels/line
PAL—35ns wide, 908 pixels/line
- Horizontal Sync Pulse:** NTSC—2.4 μ s wide, active low, TTL level
PAL—2.4 μ s wide, active low, TTL level
- Vertical Sync Pulse:** NTSC—190 μ s wide, active low, TTL level
PAL—160 μ s wide, active low, TTL level
- Overscan Support:** NTSC—768 \times 489 worst case
PAL—768 \times 576 worst case
Note: Certain software packages may use overscan this severe; however, the operating system nominally does not.
- Video Bandwidth:** 30 MHz @ -3 dB

Appendix D

Using the A3000 Keyboard

The A3000 Keyboard

The A3000 keyboard is divided into four sections:

- The Main Keyboard
- The Cursor Keypad plus Del and Help keys
- The Numeric Keypad
- The Function Keys

The general keyboard is illustrated on the following page.

When using the keyboard, keep the following points in mind:

- Keys can be program-controlled—that is, their use can be defined by the software being used (e.g., an application program, such as a word processor or spreadsheet). For specific information on the program control of keys, refer to the manual for the particular software package you are using.
- The keys on the keyboard usually repeat for as long as they are held down.
- You cannot interchange the numeral 0 and the upper case letter O, or the numeral 1 and the lower case letter l.
- In some cases several keys may be used together, either simultaneously or in a special sequence.

You can use the keyboard as well as the mouse to move around the screen and select icons, gadgets, etc. In many programs you use the keyboard to enter information. You can use the keys to tell the computer what you want it to do, and to reply to messages or questions the computer displays on the screen, these messages and questions are sometimes called "system requesters" or simply "requesters."

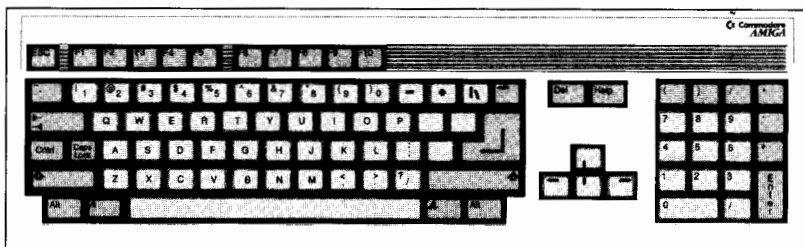

NOTE: The international keyboards have two additional keys on the main keyboard, located at the Shift key positions.

The Main Keyboard Area

The **main keyboard area** (see keyboard illustration) provides a standard alphanumeric typewriter keyboard plus additional keys with special uses and capabilities. The special keys include:

Esc



The Esc (Escape) key, located at the top left of the keyboard, is a program-controlled key, often used to expedite leaving or entering a program or a program function.

Tab



The Tab key, located two rows below the Esc key, can be program-controlled to perform tab functions. The Tab key is used extensively in word processing and desktop publishing programs.

Ctrl



The Ctrl (Control) key, located just below the Tab key, is a program-controlled key that is often used with other keys to perform special functions. The Ctrl key modifies other keys in a way similar to the way that the Shift key does.

Caps Lock



The Caps Lock key is located next to the Ctrl key. When the Caps Lock key is active a light on that key is illuminated. The alphabetic characters (A through Z) will produce upper case letters as long as the light is on. However, the upper characters on the numeric row at the top of the main keyboard area (!, ", # through /) are not affected by the Caps Lock key. To type these characters, you must hold down one of the Shift keys and press the key for the desired character. To release the Caps Lock key, press it again so that its light goes out.

Shift Keys



There are two Shift keys, marked with an upward arrow (⇧) and located on either side of the bottom row of letters (z,x,c, etc.). These keys can perform the same function as the shift keys on a standard typewriter—that is, depressing either Shift key simultaneously with any alphabetic key or with any key on the top row of the main keyboard area causes the upper character on that key to be displayed. In addition, the Shift keys are often used with other keys to perform special functions.

Alt Keys



There are two Alt (Alternate) keys, located at the extreme left and right sides of the bottom row of the keyboard. These keys are also often used with other keys to perform special functions. This key may modify other keys in a way similar to the way the Shift key does.

A



This key, known as the left Amiga key, is located on the bottom row of the keyboard, just to the left of the space bar. The left Amiga key is also used with other keys to perform special functions. This key may modify other keys in a way similar to the way the Shift key does.

A



This key, known as the right Amiga key, is located on the bottom row of the keyboard, just to the right of the space bar. The right Amiga key is also used with other keys to perform special functions. This key may modify other keys in a way similar to the way the Shift key does.

NOTE: Simultaneously depressing the Ctrl key and the left and right Amiga keys resets the A3000. See Chapter 1 in the *Using the System Software* manual for details.

Enter



The Enter key is located on the right side of the main keyboard area, in the middle two rows. You use this key to transmit a command or information to the computer. In manuals, you may see this key referred to by the symbol "↵" or the word "Return".

Backspace



The Backspace key is the key farthest right on the top row of the main keyboard area. Pressing the Backspace key deletes any characters to the left of the cursor and causes the cursor, and any characters to the right of it, to move to the left.

Del and Help Keys

To the left of the main keyboard area are the Del and Help keys.

Del



The Del (Delete) key is located just to the right of the top row of the main keyboard area. Pressing the Del key deletes the character at the cursor position. Any characters to the right of the cursor move to the left.

Help



The Help key, located to the right of the Del key, is a program-controlled key that a developer can use to provide additional information or user assistance while a program is running.

The Cursor Keypad

The four cursor keys are grouped in a small keypad located on the bottom right side of the keyboard, between the **main keyboard area** and the **numeric keypad**. These keys control the movement of the cursor (up, down, left, right) on the screen display. The direction in which each key moves the cursor is indicated by the direction of the arrow displayed on the top of the individual key. These keys may also have special functions, depending on the software application.

The Numeric Keypad

The Numeric Keypad is located to the far right of the keyboard. The keys are arranged in a calculator layout to facilitate numeric data entry. The numeric and arithmetic symbol keys on the keypad act just like the numeric and arithmetic symbol keys in the main keyboard area of the keyboard. You use the Enter key on the numeric keypad just as you use the Return key on the main keyboard—that is, to transmit data and commands to the computer.

The Function Keys

The Function Keys, located at the top of the keyboard and numbered F1 through F10, are program-controlled keys.

Using the Amiga Without a Mouse

On the Amiga, the keyboard can generally perform the same actions as the mouse. See Chapter 2 in the *Using the System Software* manual for details on using the Amiga without a mouse.

Appendix E

Using the A3000 Install Disk

NOTE: Protect the information on your original A3000 Install disk by using the write-protect tab. Make a copy of the disk and put the original in a safe place. Always use the copy, NOT the original.

The A3000 Install disk included with your computer contains the following software, designed to let you reinstall your original system software on the A3000's hard disk:

PrepHD
FormatHD
InstallHD

This appendix tells how to use this software.

The A3000 Install disk also includes a number of Workbench drawers, including Prefs, Shell, System, Expansion, Tools, Utilities and Trashcan. For descriptions of how to use these drawers, see the *Introducing the System Software* manual.

CAUTION: The Install software is concerned with reinstalling the system software only, and does not deal with any application software that you may have installed on your disk. To make sure that you have a backup copy of all application software on the hard disk, it is extremely important that you regularly use the HDBackup or the BRU (Backup and Restore Utility) software described in the *Introducing the System Software* manual.

About the Installation Software

As noted above, the reinstallation procedure involves the PrepHD, FormatHD and InstallHD programs. These programs are used in reverse order to address problems at increasing levels of severity.

Before you use these programs, you should try less drastic measures. For example, if only a few files or directories on your disk have been corrupted, you should restore the corrupted files from your regular backups. In other words, you should always try to recover your disk by using the least severe procedures first.

The PrepHD, FormatHD and InstallHD programs are summarized below:

PrepHD—Under severe conditions, your hard drive may be so damaged that a complete reconstruction is necessary. PrepHD performs a *low-level format* of the hard disk—that is, PrepHD sets up the disk information required to manage the disk as a whole prior to a complete reformatting. This program should be run only as a final resort, since all information stored on the hard disk will be destroyed. *If you use this program, you must follow it with FormatHD and InstallHD, in that order.*

FormatHD—Performs a *high-level format* of the hard disk—that is, FormatHD sets up the disk to receive the information (such as programs and data) that the user actually works with. FormatHD should be used only as a last resort when a complete reconstruction is necessary, since all user information stored on the hard disk will be destroyed. *If you use this program, you must follow it with InstallHD.*

InstallHD—Installs the system software on the selected partition. *You can use this program by itself, without having used FormatHD or PrepHD.*

Reinstalling the System Software on the Hard Disk

To do a low-level and high-level format of the hard disk and reinstall the system software, follow the instructions below.

Booting the A3000Install Disk

Boot the Amiga with the A3000Install disk in the internal floppy drive (DF0/). Do not boot from the hard disk. When the system boots, you will see the A3000Install icon on the screen. Double-click on the icon, and the A3000Install window will appear.

Using PrepHD

To prepare the entire hard disk, double-click on the PrepHD icon, and a new window will appear. The window will provide a series of prompts that will guide you through the process of performing a low-level format of your hard disk. In this process, the drive will be re-partitioned to the standard configuration.

NOTE: This operation can take up to half an hour. All information on the hard disk will be erased.

You will be asked if you are sure that you want to continue with the procedure. Type a Y for yes or an N for no, and then press Return. If you type Y, the Amiga automatically begins the PrepHD process. Note that the hard disk LED on the Amiga's front panel will not be lit during PrepHD. When PrepHD is complete, the system will display the message "Hard disk prep completed". You should then reboot the machine and run the FormatHD utility.

Be sure to leave the Install disk in the floppy disk drive when you reboot. When the Workbench screen reappears, open the A3000Install window and proceed with the formatting process as described below.

Using FormatHD

To reformat the entire hard disk, double-click on the FormatHD icon. A new window will appear, displaying the following message:

```
WARNING: This will reformat hard disk WB2.x:
All information on the hard disk will be lost!
Are you sure you want to continue?
```

Again, type either a Y for yes or an N for no and press Return.

The system must format the partition cylinder by cylinder, so do not be alarmed if it seems to be taking a long time. You will be able to follow the progress on the screen. The system displays which cylinder is being formatted/verified and how many cylinders are left to be formatted.

When formatting is complete, a message like the following appears:

```
Hard disk format complete.
Would you like the system software to be installed
on your hard disk?
```

If you want to proceed with the installation, type Y and press the Return key. The FormatHD program will then start the InstallHD program. If you type N and press Return (or just press Return), the FormatHD program will end without calling the InstallHD program.

Using InstallHD

To reinstall the system software on the hard disk drive, double-click on the InstallHD icon. This program copies the files from the Workbench and Extras disks (versions 1.3 and 2.0) and the A3000 Kickstart disk onto the hard disk. You will have to insert the diskettes into the disk drive(s) at the proper time. Be sure to keep unaltered copies of all these floppy disks for this purpose.

After double-clicking on the InstallHD icon, you will see a message telling you that the program will reinstall the system software on your hard disk, and that the files on the hard disk will be overwritten. You will then be asked:

Are you sure you want to continue?

Type Y for yes or N for no and press Return. If you type Y, watch the screen for requesters that ask you to insert a disk into the floppy drive so that the appropriate files can be copied to the hard drive.

The first requester that appears asks you to insert your Workbench2.0 disk into any drive. When the disk is inserted, the program will copy the files onto the hard drive. Subsequently, you will be prompted to insert each of the five original system disks into any drive.

When the system software has been reinstalled and the system has been properly configured, you will see the following message:

Software installation is now complete.

Remove all floppy disks from the Amiga and reboot the machine.

When the Workbench screen appears, you will note that the hard disk has been returned to the configuration it had when shipped from the factory: that is, only the system software is on the disk, and the disk contains only the default partitions. Therefore, any changes that you had made to the hard disk (e.g., adding partitions or installing application software) will have to be redone. If you had added partitions, you can use HDToolbox to reinstall them. (See Chapter 6 in the *Introducing the System Software* manual for details on using HDToolbox.) If you had installed application software, you should have used HDBackup or BRU (Backup and Restore Utility) to make backup copies of these programs. Use the backup copies to reinstall the software. (See the *Introducing the System Software* manual for details on using HDBackup and BRU.)

Appendix F

A3000 Schematics

NOTE: The drawings in this appendix are for reference only and are subject to change without notice as required by product improvements.

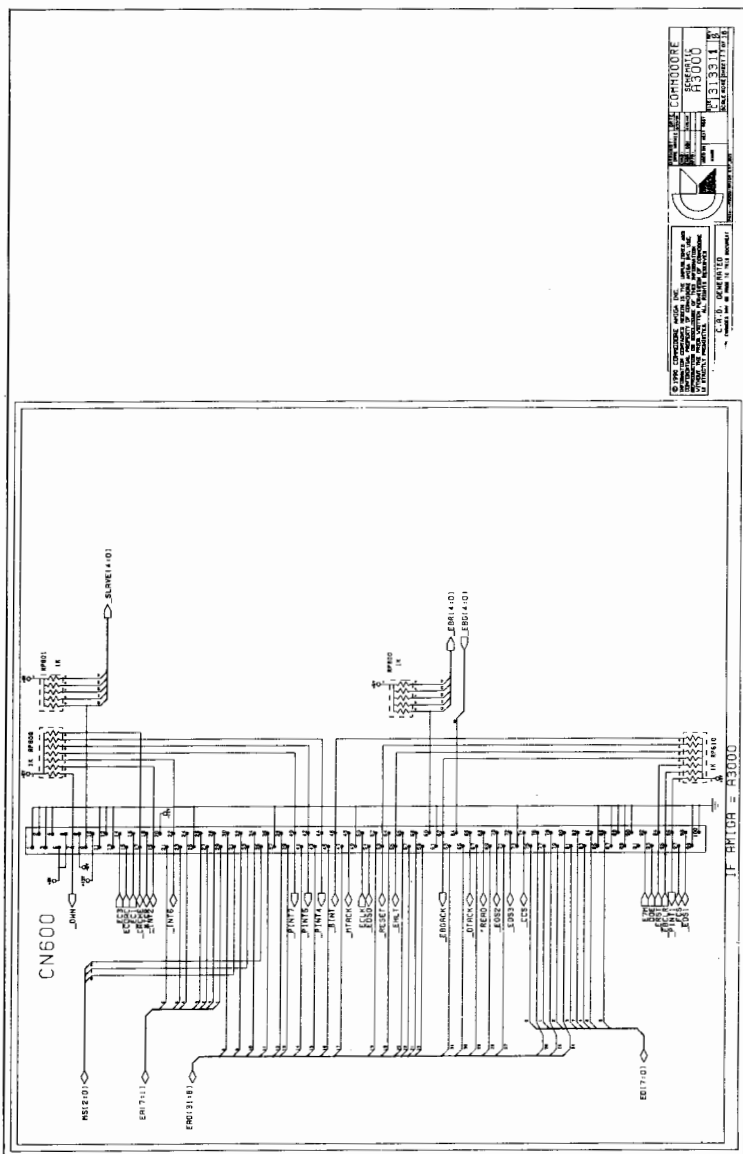

		PART NUMBER 15-47400-008E
TITLE R3000		PART NUMBER 15-47400-008E
DATE 11/13/51		PART NUMBER 15-47400-008E
DRAWN BY [Signature]		PART NUMBER 15-47400-008E
CHECKED BY [Signature]		PART NUMBER 15-47400-008E
APPROVED BY [Signature]		PART NUMBER 15-47400-008E
C. R. B. GUARANTEED		PART NUMBER 15-47400-008E

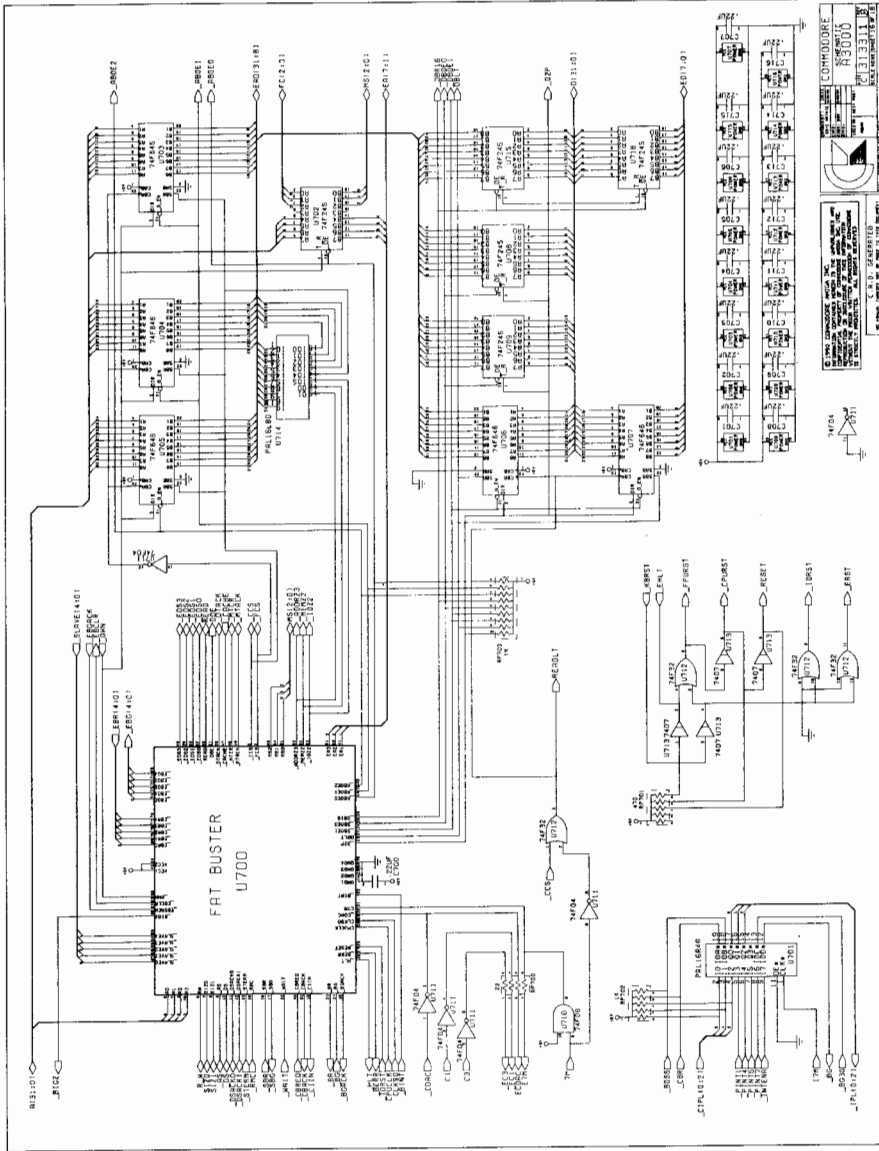

Appendix G

Jumper Settings

JUMPER SETTINGS

JUMPER	PINS	313311	313311	313311	313311	FUNCTION
		-01	-02	-03	-04	
J100	4	2-3	2-3	1-2	1-2	Quadrature Clock Phasing
J101	3	2-3	2-3	2-3	2-3	FPU Clock Source
J102	3	2-3	2-3	2-3	2-3	System Clock Source
J103	4	3-4	3-4	3-4	3-4	FPU CS/BERR
J104	3	1-2	1-2	1-2	1-2	CPU Clock Source
J151	3	2-3	2-3	1-2	1-2	ROM Timing
J152	3	2-3	2-3	1-2	1-2	ROM Timing
J180	3	2-3	2-3	2-3	2-3	A2000 ROM Compatibility Jumpers
J181	3	2-3	2-3	2-3	2-3	A2000 ROM Compatibility Jumpers
J200	3	1-2	2-3	1-2	2-3	NTSC/PAL Select
J350	3	1-2	1-2	1-2	1-2	Tick Clock Source
J351	3	2-3	2-3	2-3	2-3	Disable DF1: (1-2 to enable)
J352	3	2-3	2-3	2-3	2-3	Light Pen Source
J481	3	2-3	2-3	2-3	2-3	VDE Scan Double Only Jumper
J482	3	1-2	1-2	1-2	1-2	VDE PLL Loop Adjust
J483	3	-	-	-	-	VDE Factory Test Points
J800	3	1-2	1-2	1-2	1-2	WD33C93 Speed
J851	3	1-2	1-2	2-3	2-3	RAM Controller Speed Jumper
J852	5	4-5	4-5	4-5	4-5	-012A Ramsey only (See Notes)
J853	3	2-3	2-3	2-3	2-3	-012A Ramsey only (See Notes)

Notes:

J150, J151: ROM Timing.

The ROM timing circuit provides four different speed settings to match the output enable and access timing of the system ROMs.

To set the jumpers, determine the output enable time and access times for the ROMs you wish to use. The ROM must have lower values than for the setting you select.

System standard ROMs have $T_{oe} = 110$ ns, and $T_{acc} = 250$ ns.

CLK	J151	J150	T_{oe} (min)	T_{acc} (min)
16 MHz	2-3	2-3	157 ns	250 ns
16 MHz	2-3	1-2	220 ns	312 ns
16 MHz	1-2	2-3	282 ns	375 ns
16 MHz	1-2	1-2	345 ns	437 ns
25 MHz	2-3	2-3	90 ns	160 ns
25 MHz	2-3	1-2	130 ns	200 ns
25 MHz	1-2	2-3	170 ns	240 ns
25 MHz	1-2	1-2	210 ns	280 ns

G-2 *Jumpers*

J180, J181: ROM Compatibility Jumpers			
	J180	J181	
A2000/A500 ROMs:	1-2	1-2	
A3000 ROMs:	2-3	2-3	

J851-J853: RAM Controller Compability Settings			
	J852	J853	
-012A Ramsey w/ 256Kx4 RAMs	4-5	2-3	
Later Ramseys w/ 256Kx4 RAMs	2-3	1-2	
Later Ramseys w/ 1Mx4 RAMs	1-2	1-2	

See the motherboard illustration on the following page for jumper locations.

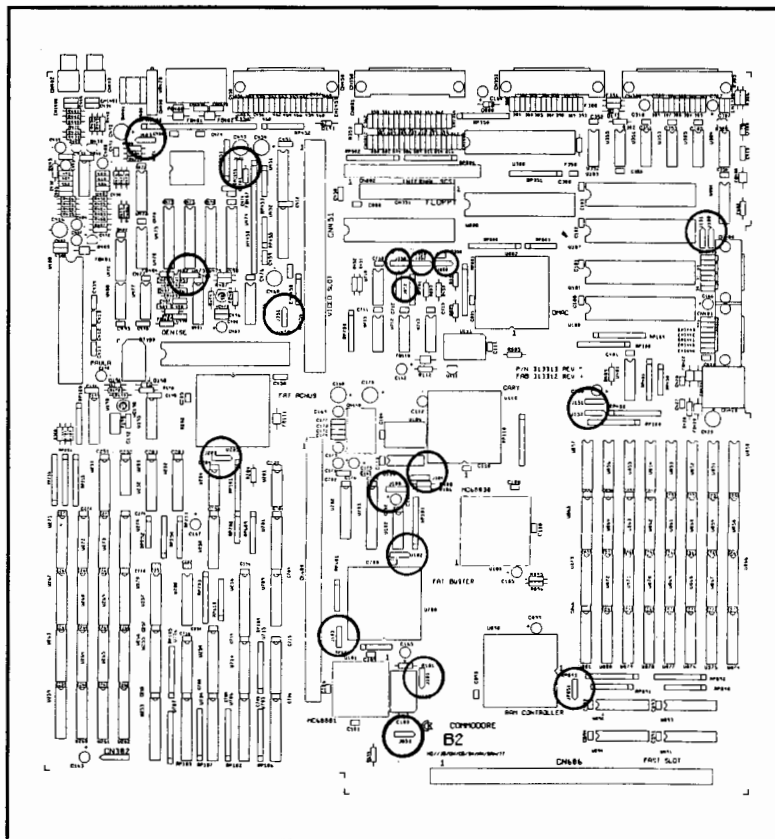

Jumpers Locations on the A3000 Motherboard

Index

100-pin expansion slot, B-13, B-17

A

A3000

- booting, 3-8
- caring for, 3-20
- expanding, 1-7, 4-1
- features, standard, 2-1, 2-3
- hard disk, 3-17, 3-19, E-1 – E-6
- keyboard, D-1
- overview, 1-1
- parts, 1-3
- schematics, F-1 – F-17
- turning off, 3-16
- turning on, 3-7

A3000 documentation, 1-8

- Quick Connect, 1-7, 1-8, 3-7, C-3

Using the System Software, 1-2,

- 1-7, 1-8, 2-2 – 2-7, 3-1, 3-5,
- 3-6, 3-8, 3-10, 3-11, 3-14,
- 3-15, 3-17

active low signal, B-1

adding

- disk drives, 4-4
- options, 4-6
- SCSI devices, 4-4, 4-12

AmigaDOS, 3-2, 4-5, C-1, C-2

analog RGB output

application programs, 3-1

Autoconfig, 2-5

B

backing up

- floppy disks, 3-14
- hard disk, 3-18, 3-19, E-1
- original disks, 3-14

booting the A3000, 3-8

- from floppy disk, 3-8
- from hard disk, 3-8

Bridgeboard, 1-1

BRU (Backup and Restore Utility),

E-1, E-6

built-in clock/calendar, 1-6

bus expansion slots, 4-1, 4-2, 4-8

C

cache memory, 2-1

CAD/CAM programs, 2-6

caring for

- A3000, 3-20
- floppy disks, 3-23
- mouse, 3-21

Chip RAM, 1-1, 4-3, 4-13, 4-15,
4-18, 4-19

cleaning mouse, 3-21

clock speed, A-1

command line processing, 2-4

composite signal

connecting a multiscan monitor,
C-3

connecting SCSI devices, 4-12, 4-23

connectors

external

- DB25 male (serial port), B-2
- DB25 female (parallel port),
B-4
- DB23 male (15MHz video
port), B-6
- VGA DB15 female (31 MHz
video port), B-7
- DB23 female (floppy disk
drive port), B10
- DB25 female (SCSI port), B-11

internal

- SCSI connector, 2-3, 4-23
- (motherboard), B-12
- 100-pin video slot
standard, B18
- extended, B-19

contents, hard disk, 3-19

coprocessors, 4-1

numeric, A-1

multichip, A-1

copying programs to hard disk, 3-19

CPU (central processing unit), 1-3, A-1

cursor keypad, D-5

D

daughterboard 4-2, 4-3, 4-8, 4-9

female connector, B-7

DB23 female connector, B-10

DB23 male connector, B-6

DB25 female connector, B-4

DB25 female connector, B-11

DB25 male connector, B-2

DFO, 3-8

DIP RAM, 4-15, 4-19, 4-22

disk drives, adding, 4-4, 4-11, 4-12

disk, working, 3-14

disks/drives

- floppy, 1-4, 1-6, 3-2, 3-3, A-2
- hard, 1-4, 1-6, 2-2, 3-2, 3-5, 3-17,
A-2, E-1 – E-6

Index

Display Enhancer, 1-2, 1-3, 2-2, 2-6, C-1
 adjusting fine tuning control, C-6
 connecting a multiscan monitor, C-3
 external/internal genlock compatibility, C-5
 features, C-2
 operation and compatibility, C-4
 technical specifications, C-11
 troubleshooting, C-9
 video connector ports, C-5, C-7, C-9

display modes, 2-6, 2-7
DMA SCSI controller, 1-2, 1-3, 2-3, 4-23
documentation, A3000, 1-8
double clicking, mouse button, 3-11
dragging, windows, 3-14
DRAMS, 4-14 – 4-19
 Page Mode, 4-17
 Static Column Mode, 4-17

E

ECS (Enhanced Chip Set), 1-2, C-1, C-2
enable/disable mode switch, C-2, C-4, C-7, C-8
Enhanced Denise chip, 2-2, C-1
expanding the A3000, 1-7, 4-1
 Chip RAM, 4-3
 memory, 4-3
 PC emulation
expanding
 bus, 4-1
 fast, 4-1, 4-2
 PC/AT, 4-1
 video, 4-1, 4-3
expansion slots, 1-2, 1-4, 2-5, 4-1
extended video slot
external connectors, 1-4, B-10

F

Fast RAM, 1-1, 4-13 – 4-17
fast slot, 4-1, 4-2
features, 2-1
 hardware, 2-1 – 2-3
 standard Amiga, 2-3
floating point unit, 2-1
floppy disk drive, installing
floppy disk port/connector, B-10
floppy disks, 1-5, 3-2, 3-3, 3-23
formatting disks, 3-17

G

gadgets, 3-13, 3-14
genlock, 1-2, 1-7, 2-2, 4-3, C-1
getting started, 3-1
graphical user interface (GUI), 2-3, 3-9
graphics RAM, 1-1
graphics display modes, 2-6
graphics capabilities, 2-5

H

hard disk, 2-2, 3-2, 3-5, 3-17, 4-4, 4-12, E-1 – E-6
 adding, 4-4, 4-12
 backing up, 3-18, E-1, E-6
 contents, 3-19
 copying programs to, 3-17
 formatting, 3-17, E-2, E-4
 installing, 4-12
 loading programs from, 3-18
 partitions, 3-19, E-3, E-6
 saving/retrieving files, 3-18
hardware features
HDBackup, 3-19, E-1, E-6
high-resolution (Hires) screen, 2-5, 2-6

I

I/O connector pin assignments
icons, 2-3, 3-9, 3-11
installing
 Chip RAM, 4-20
 expansion cards, 4-8
 Fast RAM, 4-20
 floppy disk drive, 4-10, 4-11
 hard disk drive, 4-10, 4-12
 RAM chips, 4-13
 video expansion cards, 4-9
 interfaces A-1
 internal SCSI connector
 external, A-1
 internal, A-1

J

joystick pin connectors, B-9
jumpers, 4-11, 4-12, G-1—G-3

K

keyboard areas, D-2
 cursor, D-5
 main, D-2
 numeric, D-5, D-6
keyboard port
keyboard, 1-5, A-1, D-1 – D-6

- L**
left mouse button, 3-11
light pen pin connectors, B-9
loading programs
 from floppy disk, 3-15
 from hard disk, 3-18
location of RAM sockets on
 motherboard, 4-22
- M**
main keypad
main keys
 Alt, D-4
 Amiga, D-4
 Backspace, D-5
 Caps Lock, D-3
 Ctrl, D-3
 Del, D-5
 Enter, D-4
 ESC, D-2
 Function keys, D-6
 Help, D-5
 Shift, D-3
 Tab, D-3
main unit, 1-3
memory expansion on motherboard,
 4-3
menu bar, 3-12
menu button, 3-6, 3-12
menu, 3-9, 3-12
microprocessor, 1-1
microprocessor, 68030, 2-1
monitor, 1-6, 3-7
motherboard, 1-1, 1-2
motherboard, location of RAM
 sockets on, 4-22
mouse buttons
 menu, 3-6, 3-12
 selection, 3-6, 3-11 – 3-13
mouse port
mouse, 1-5, 3-5, 3-6, 3-11
mouse, caring for, 3-21
mouse/game controller
 connectors/ports
moving pointer and selecting, 3-11
MS-DOS, 4-5
multiscan monitor, 2-6
 connecting, C-3
multitasking, 2-4, 3-13
- N**
NTSC video standard, 1-3, 2-5
numeric coprocessor, 68881/68882,
 1-1, 2-1, 2-2
numeric keypad, D-5, D-6
- O**
open-architecture machine, 1-1
operating systems, 3-2
options, adding, 4-6
overscan, C-2, C-11
overview of the Amiga, 1-1
- P**
Page Mode DRAMS, 4-14
PAL video standard, 2-5
parallel port/connector, B-4
partitions, hard disk
 system, 3-19
 work, 3-19
parts of the A3000, 1-3
PC [personal computer] emulation
 with bridgeboard, 1-1, 1-4,
peripherals, adding
 external, 1-7
 internal, 1-7
pin assignments, I/O connectors, B-1
pixels, 2-5, 2-6
pointer, 3-9 – 3-11
power supply, 1-4, 4-10, A-1
Productivity mode, 1-2, 2-2, 2-6
programming languages, 3-1
protecting floppy disk info, 3-3
- Q**
Quick Connect, 1-7, 1-8, 3-7, C-3
- R**
RAM sockets, location of on
 motherboard, 4-22
RAM, 1-1, 1-3
 Fast, 1-1, 4-3, 4-14, 4-16, A-1
 Chip, 1-1, 4-3, 4-13, 4-15, 4-18,
 4-19, A-1
read, from disk, 1-6, 3-3
read/write position, 3-4
removing
 floppy disk drive, 4-11
 hard disk drive, 4-12
removing cover, A3000, 4-6
RGB monitor connector, C-3
rebooting, 3-16
ROM, A-1
- S**
saving your work, 3-15
saving/retrieving hard disk files,
 3-18
schematics, A3000, F-1 – F-17
screen size, pixels, 2-6
SCSI devices, adding, 4-4, 4-12

Index

SCSI, DMA

- controller, 1-2, 1-3, 2-3, 4-23
- devices, 1-2, connecting, 4-23
- SCSI port/connector, B-11
- selection button, 3-6, 3-11 – 3-13
- serial port/connector, B-2
- shell, 2-4
- software, 1-5, 3-1
- static column mode DRAMS
- standard Amiga features, 2-1, 2-3
- storage medium, 3-2
- static electricity, 4-13
- stereo sound, 2-4, A-3
- Superhires mode, 1-2, 2-2, 2-6

T

- technical specifications, A-1
- text-to-speech conversion, 2-4, A-3
- title bar, 3-11
- turning off A3000, 3-16
- turning on A3000, 3-7

U

- Using the System Software, 1-2, 1-8, 2-2 – 2-7, 3-1, 3-5, 3-6, 3-8, 3-10, 3-11, 3-14, 3-15, 3-17
- utilities, 3-2
- using Amiga without mouse, D-6

V

- video modes
 - Productivity, 1-2, 2-2, 2-6, C-1, C-2, C-4
 - Superhires, 1-2, 2-2, 2-6, C-1, C-2, C-5
- video slot, 4-3
- video standards
 - NTSC, 4-4, A-2, C-2, C-4
 - PAL, 4-4, A-2, C-2, C-4
- video port/connector, 1-6, B-6, B-7
- video expansion, 1-2, 4-3

W

- wait pointer, 3-12
- windows, 3-9
- Workbench, 2-3, 2-4, 2-5, 3-9, 3-11, 3-19
 - screen, 3-8, 3-10
 - features, additional, 3-13
- Work window, 3-12
- working disk, 3-5, 3-14
- write protect, 3-3
- write, to disk, 1-6, 3-3
- write-protect tab, 3-3
- write-inhibit, 3-3, 3-4
- write-enable, 3-3, 3-4
- Work icon, 3-12

Z

- Zorro cards, 4-1, A-1, B-13 – B-17
- ZIP RAM, 4-15, 4-19, 4-22

 **Commodore**[®]
AMIGA[®]